

50c

JULY 1966

# Radio-Electronics™

IND

TELEVISION • SERVICING • HIGH FIDELITY

HUGO GERNSBACK, Editor-in-chief

A GERNSBACK PUBLICATION

New! Nationwide listing  
stereo-FM stations

Careers in  
military electronics



Plus

SPECIAL SECTION

Stereo FM

If you think  
all replacement tubes are alike,  
you've got a surprise coming

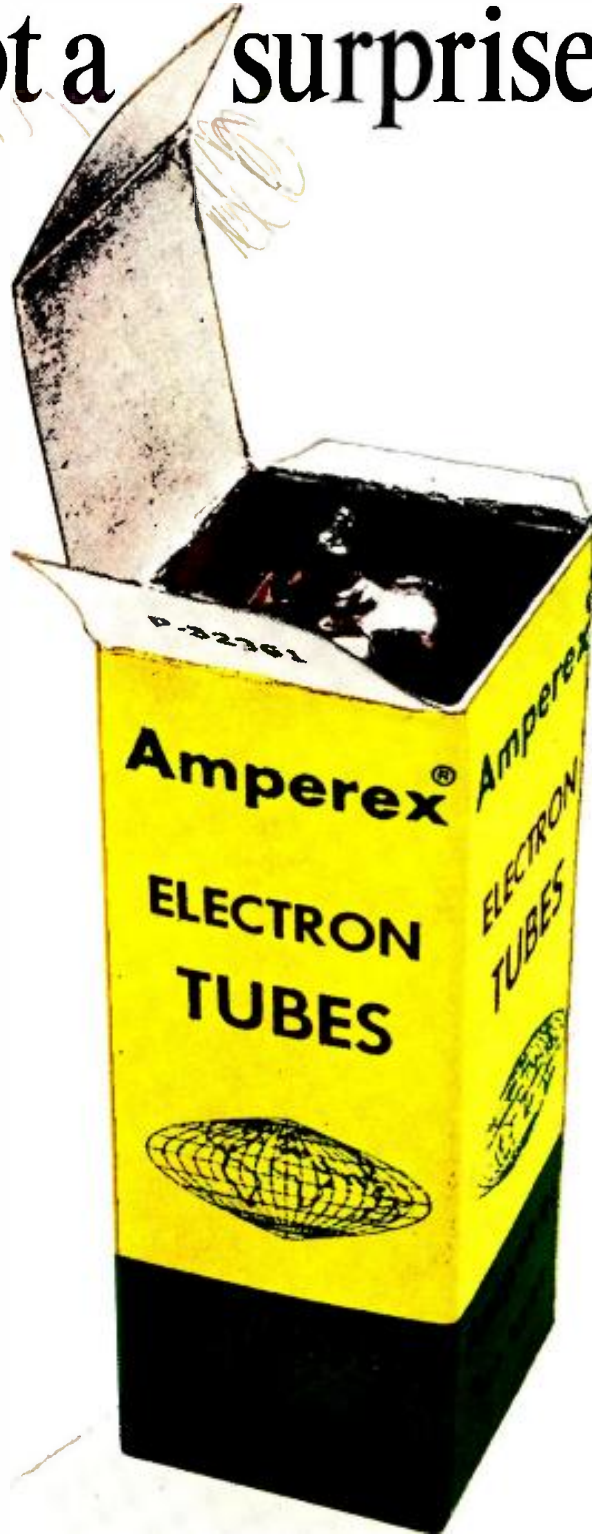

© 1966, AMPEREX ELECTRONIC CORP., HICKSVILLE, L. I., NEW YORK 11802  
Circle 7 on reader's service card

# Crime does pay!



**Every 40 seconds a burglary takes place in the United States.**

#### TECHNICAL INFORMATION

The RADAR SENTRY ALARM is a complete U.H.F. Doppler Radar System which saturates the entire protected area with invisible r.f. microwaves. It provides complete wall to wall—floor to ceiling protection for an area of up to 5,000 square feet. Without human movement in the protected area, the microwave signal remains stable. Any human movement (operation is unaffected by rodents and small animals) in the area causes the doppler signal to change frequency approximately 2 to 4 cps. An ultra-stable low frequency detector senses this small frequency change, amplifies it and triggers the police type siren—which is heard up to a half mile away.

In addition, the RADAR SENTRY ALARM's protection can be extended to other areas with the use of the following optional accessories:

- remote detectors for extending coverage to over 10,000 sq. ft.
- rate of rise fire detector U.L. approved for 2,500 sq. ft. of coverage each (no limit on the number of remote detectors that can be used)
- hold-up alarm
- central station or police station transmitter and receiver (used with a leased telephone line)
- relay unit for activating house lights
- battery operated horn or bell which sounds in the event of: powerline failure; equipment malfunction or tampering

At that rate, it's a multi-million dollar a year business...for burglars.

And an even better business opportunity for you.

Why? Because burglary can be stopped...with an effective alarm system.

In fact, police and insurance officials have proved that an alarm system reduces, and in many cases, eliminates losses—even helps police apprehend the criminal.

Here's where you come in.

Only a small percentage of the more than 100 million buildings—stores, offices, factories, schools, churches and homes are protected by an effective alarm system.

That means virtually every home, every business is a prospect.

You can sell them!

And you don't have to be a super-salesman to sell the best protection available—a Radar Sentry Alarm unit. All you have to do is demonstrate it...it sells itself.

A glance at the technical information shows why.

It's the most unique and effective alarm system ever invented.

And here's the proof.

In the past six years, thousands of RADAR SENTRY ALARM units have been sold in the Detroit, Michigan area alone—sold by men like yourself on a part-time and full-time basis.

Here are just a few customers who are protected by RADAR SENTRY ALARMS:

U. S. Government  
U. S. Air Force  
Detroit Board of Education  
Hundreds of Churches,  
Banks, Businesses and  
Homes.

Everyone is a prospect.

So take advantage of your profession! Put your technical knowledge and experience to work for you in a totally new area—an area that will make money for you!

Don't wait!

Let us prove that crime does pay.

Become a distributor.

Write now for free details.

#### RADAR SENTRY ALARM



Circle 8 on reader's service card

Mail to: RADAR DEVICES MANUFACTURING CORP.  
22003 Harper Ave., St. Clair Shores, Michigan 48080



Please tell me how I can have a business of my own distributing Radar Sentry Alarm Systems. I understand there is no obligation.

RE-7

Name \_\_\_\_\_

Address \_\_\_\_\_

City \_\_\_\_\_ State & Code \_\_\_\_\_

## What's Next For Television?

In a slightly darkened room overlooking Central Park in the center of Manhattan, three people—a large man, his wife, and their teenage daughter—sit gazing at the dim glow of a huge television screen. To call it *huge* is no exaggeration; the screen stretches 13 feet across one entire wall of the room.

Near the left side of the wide, wide picture, a doorknob clicks and all three watch the door squeak open on slightly rusty hinges as a hero-type undercover agent slips into the room, stops, looks around, and then nods to a partner waiting in the hallway behind him.

The watching wife suddenly “ooo’s” involuntarily, for her ear has caught the metallic rustle of drapes; the eyes of the trio shift in the direction of the sound—to the extreme right side of the room, where a TV-screen villain is silhouetted behind the drapes, waiting for the two spies. So far, the spies haven’t spotted the trap they’re walking into, and the three TV-watchers hiss warnings at them.

As if in answer to the ringside warnings, the leader stops, signals his companion to silence, draws a long-barreled little pistol, and takes a cautious step toward the two shoes he now sees sticking out below the curtain. A violent movement of the drapes, a “vvvtt” as the little gun spurts from the left side of the room, a tinkling of glass on the right as the bullet narrowly misses its mark and shatters its way through the plate-glass picture window. The figures merge at the center, scuffle noisily there. A loud thud—and one lively body disentangles itself from the melee and retreats hurriedly out the door at the left. Fading footsteps are heard echoing down the corridor. . . .

The big man pulls himself out of his TV chair, sighs, turns on a large table lamp, and wipes his perspiring brow. His wife and daughter are both breathing heavily from the emotion of suspense they’ve just been through. They’ve been almost literally a part of the scene before them. Through the realism of stereophonic sound and large-screen, three-dimension television, they’ve been as nearly “inside” the scene as it’s

possible for anyone to imagine.

Of course, this little scenario I’ve just narrated is fiction. Our trio of viewers is purely fanciful—as is the large-screen, three-dimension, stereo-sound TV receiver.

But the concepts are closer to reality than you might think. Holographic techniques already permit projection in three dimensions and color, and other means for 3-D television have been suggested. Ways to send more than one television picture on a single station channel are in final stages of development. The FCC has on file several suggestions for adding stereo sound to television programs. Giant-screen projection (or even direct-sweep) systems would show life-size images, and changing the picture’s aspect ratio for wide screening should be a snap. The usual objections to close-up viewing of large TV pictures could be overcome by special interlacing techniques.

Of course, it isn’t all as simple as that. The various concepts have to be merged, and maybe even redesigned so they *can* be merged. The composite signal would differ considerably from what we now transmit, and the FCC would want to approve the changes. Receivers would be different, too, but perhaps not extremely so. And adding color to three-dimensional projection brings still more complexity to the plan.

But don’t sell the great innovators short. Our electronic age is peopled with bright talents who make a specialty of doing what seems impossible or unlikely.

Color television and stereo FM—just germinal ideas not many years ago—are commonplace, now. It won’t be long until both of these entertainment forms have reached saturation or “second-set” status. Do you think the far-seeing leaders of this industry will be satisfied to leave the public with nothing more imaginative than these? Not likely.

Wide-screen, large-picture, three-dimension, stereo-sound television sounds like a worthy hurdle. Wonder who’ll be first . . . ?

—Forest H. Belt

# Radio-Electronics

JULY 1966 VOL. XXXVII No. 7  
Over 55 Years of Electronic Publishing

## EDITORIAL

- 2 What's Next For Television?.....Forest H. Belt

## STEREO FM SPECIAL FEATURES

- \*30 World's Most Expensive FM Tuner.....Peter E. Suthem  
*See what there is special about it*
- 41 Stereo FM Stations: U.S. and Canada  
*Find out which ones are broadcasting in your town*
- 44 Aligning the FM Stereo Radio.....Leonard Feldman  
*Make sure the front end is OK before you blame the mpx stages*
- 52 Hunting Down Trouble in Stereo Receivers....William Krueger  
*With special attention to transistor circuits* and E. F. Rice
- 65 Equipment Report: Heathkit AR-14 All-Transistor Stereo-FM Receiver

## RADIO

- 40 What VSWR Can Do to Your Communications...David L. Pippen  
*Two charts—one especially for CBers—show what you lose from mismatching*
- 51 Soup Up Your All-Band Transistor Portable...John Potter Shields  
*A few simple improvements boost performance*

## GENERAL

- 35 The Military Electronics Specialist Gap.....S. David Pursglove  
*Armed Forces are searching frantically for trained personnel*
- 37 Computers Galore
- 58 Vectors Show How Circuits Work.....Norman Crowhurst  
*Read this before you give up on vectors*

## ELECTRONICS

- 55 Summer Fun With a Sensitive Metal-Finder.....G. H. Gill  
*Build it in a few evenings, then use it for years!*

## TEST INSTRUMENTS

- 66 Equipment Report: B & K 1245 Color Generator

## AUDIO—HIGH FIDELITY—STEREO

- 48 Build the C O P 30/30 Transistor Stereo Amplifier ..Richard J. DeSa  
*Clean audio for only a few dollars*

## TELEVISION

- 38 Show and Tell.....Homer Davidson  
*Pictures are your best troubleshooting clues*
- 60 Restoring Middle-Aged CTC's.....Jack Darr  
*No tricks—just money-making instructions*
- 68 Color Television Systems: Which Way Will Europe Go? ..Eric Leslie  
*Can you guess? Here are all the systems being considered*
- 73 Hunting Horizontal Output Troubles.....William Darragh  
*More on basic TV troubleshooting*

## THE DEPARTMENTS

- |   |                          |
|---|--------------------------|
| 10 Correspondence                               | 90 Noteworthy Circuits   |
| 91 New Books                                    | 70 Technotes             |
| 87 New Literature                               | 76 Try This One          |
| 81 New Products                                 | 43 What's Your EQ?       |
| 67 New Semiconductors,<br>Microcircuits & Tubes | 43 50 Years Ago          |
| 4 News Briefs                                   | 78 Reader's Service Page |

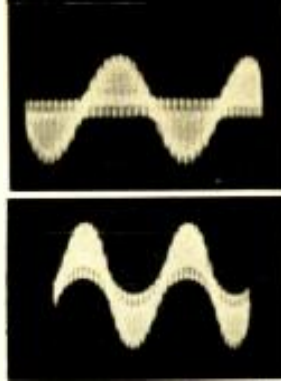

p 44—ALIGN STEREO FM

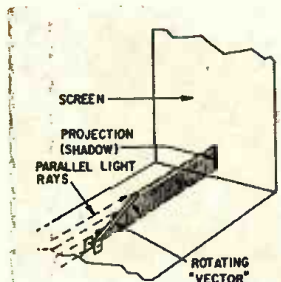

p 58—VECTORS MADE EASY



p 55—SENSITIVE DETECTOR

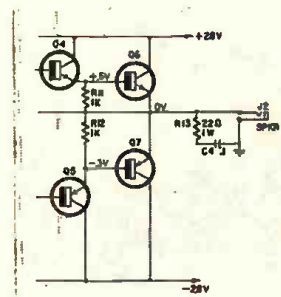

p 48—COMPL OUTPUT



p 38—PICS OFFER CLUES

p 68—EUROPEAN COLOR

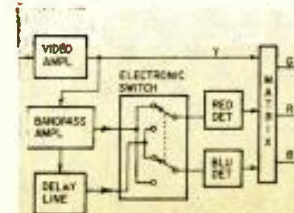

RADIO-ELECTRONICS, July 1966, Volume XXXVII, No. 7. Published monthly by Gernsback Publications, Inc., at Ferry Street, Concord, N. H. 03302.

Editorial, Advertising, and Executive offices: 154 West 14th Street, New York 10011. Circulation Office: Boulder, Colo. 80302.

Second-class postage paid at Concord, N. H. Printed in U.S.A. One-year subscription rate: U. S. and possessions, Canada, \$5. Pan-American countries, \$6. Other countries, \$6.50. Single copies: 50c. © 1966, by Gernsback Publications, Inc. All rights reserved.

POSTMASTERS: Notices of undelivered copies (Form 3579) to Boulder, Colo. 80302.

## \*COVER FEATURE



p 30—Elaborate tuner displays workmanship and design sophistication not often found. Cost is high, but worth it.

## CAREER SERIES



p 35—Armed Services is employer of large numbers of trained technicians.



Member,  
Institute of High Fidelity.  
Radio-Electronics is indexed in  
Applied Science & Technology  
Index (formerly Industrial  
Arts Index)

# NEWS BRIEFS

## MULTIPLEX TV COMING?

A practical device for multiplexing two television programs on a single channel has been announced by a New York firm, which is applying for FCC approval of an on-the-air test. According to the inventor, Harold Walker, a Metuchen, N. J. TV engineer, the new system, known as DuoVision, resembles color TV in that the signal for the second program is modulated on a sub-carrier. The signal is then modified in such a way that any "leak-through" to the main picture would produce a simple gray tone. The multiplexed second picture then gives no evidence of its presence on an ordinary TV.

To obtain the second picture, a TV set with an adapter picks up the subcarrier and demodulates it, much as is done in color TV. The main picture, of course, is not picked up, and the inventor, states that there is no interference from the main picture.

The subcarrier picture can be received in black-and-white only, although color pictures can be received on the main channel.

## SYLVANIA INTRODUCES MOBILE TV STUDIO CONTROL ROOM

A self-contained studio control room in an air-conditioned Chevy-Van is now available to users of closed-circuit educational TV systems. The mo-

bile unit includes a power generator, a tape recorder, monitors, and two transistor TV cameras equipped with viewfinders and zoom lenses. One camera is on a revolving turret ring and can be elevated through a 3-foot-diameter roof hatch for over-the-crowd shots.

The mobile TV production unit can be used anywhere to tape events for playback later over a closed-circuit TV system. Thomas R. Shepherd, manager of Education Systems, said that the unit could be shared by schools in a district, thereby cutting equipment expenses. Other savings are also possible, since the availability of the unit often makes it unnecessary to transport student groups to places for educational purposes.

## ELECTRON MICROSCOPE SEES 10-ATOM CELL OF CARBON

R. D. Heidenreich of Bell Telephone Laboratories reports that he has directly observed and identified a hexagonal cell of carbon for the first time. He used a modified electron microscope with resolution of 2 Angstroms. The diameter of the cell is about 5 Angstroms, or one 23-billionth of an inch. There are 10 atoms in each cell.

The microscope used was a Siemens Elmskop I, modified by H. Armbruster of Siemens-America. Besides

improving the stability of the microscope, Armbruster decreased the focal length of its objective lens from 2.8 to 1.9 mm by increasing the intensity of the magnetic field that forms the lens. This improved the point-to-point resolution of the instrument significantly.

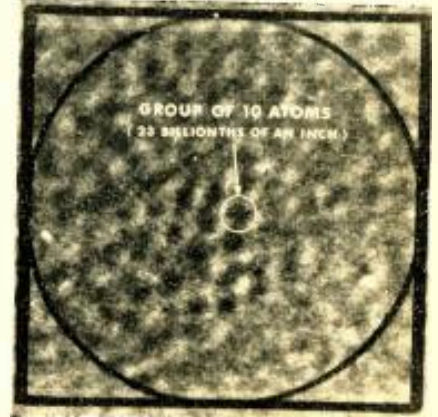

The circled area in this micrograph is a single cell of carbon. It was viewed by R. D. Heidenreich of Bell Telephone Laboratories, who used a modified Siemens type Elmskop I electron microscope, with resolution of two Angstroms.

To get as thin a layer of carbon as possible, Heidenreich evaporated a sample of carbon onto a plastic substrate, which was dissolved, leaving only an exceedingly thin layer of carbon atoms. The layer was still many atoms thick, so the image on the microscope is a projection that includes underlying and adjacent cells. Bell Labs hopes to prepare thinner and thinner films, possibly only one atom thick. In that case, it might be possible to observe a single atom.

## NEW COPYING MACHINE FORECASTS HOME FACSIMILE

A facsimile machine that can be hooked up to the ordinary telephone is now being made by Magnavox and marketed by Xerox. The device, known as *Magnafax*, is about the size of an electric typewriter, and can transmit or receive anything from typewritten pages to halftone photos, to or from another *Magnafax* machine. A moving stylus impresses variations of light and darkness on ordinary carbon-paper "copy sets" of the kind used in offices.

The device is not aimed at the consumer as yet, but according to Xerox president Joseph C. Wilson it "is more of a consumer market than we've ever been in." The minimum cost



TV STUDIO CONTROL ROOM on wheels for use in educational television has been introduced by Sylvania. The 211-cubic-foot unit—an air-conditioned Chevy-Van—includes a power generator, video tape recorder, monitors, two TV cameras with viewfinders, tripods, dolly equipment, portable lighting unit and power and camera cable. One of the cameras can be elevated through a hatch in the roof for over-the-crowd shots.

**DEVRY TECH** NOT ONLY TRAINS  
YOU... BUT HELPS YOU GET  
STARTED AT NO EXTRA COST IN  
THE **BIG-MONEY FIELD** OF

# ELECTRONICS!

## ✓ PREPARE AT HOME

Whether you want to prepare for a good-paying new job or for advancement in Electronics with your present employer, DeVry Tech offers specialized educational programs designed to meet your needs. You set up your own HOME LABORATORY and work over 300 construction and test procedures to develop on-the-job type skills. You build a quality Transistorized Meter, a 5-inch Oscilloscope and a special Design Console. DeVry also includes modern "programmed" texts, instructive motion pictures, Consultation Service. Effective? Yes!

## ✓ RESIDENT SCHOOL

If you prefer you may get all of your training in DeVry's U.S. or Canadian resident schools under the close guidance of friendly, experienced instructors. You work with a wide variety of commercial equipment similar to that actually used in industry as you prepare in our laboratories for a technician's job in Communications, Microwaves, Radio-Television, Automation, Radar, Computers, or other branch of Electronics. DeVry even provides part-time job placement service to those who wish to earn extra money while attending day or evening classes.

## ✓ PLACEMENT SERVICE

Meet W. E. Bartz, who has helped thousands of DeVry men toward exciting, profitable careers in Electronics. When YOU complete your program, he will help you too. As Placement Manager in touch with business and industry across the nation, Bartz knows the employer demand for DeVry-trained men. He has cooperated in placing our graduates with thousands of firms!

Men 18-45, start preparing NOW for this vast opportunity field. Soon you should be ready for DeVry's valuable employment help!

HOME LABORATORY EQUIPMENT  
— YOURS TO KEEP!



EXPERIENCED  
INSTRUCTORS



**MAIL COUPON TODAY!**

No Advanced  
Education or  
Previous Technical  
Experience Needed  
to Get Started

Your ambition and desire to succeed are more important! DeVry guides you every step of the way toward success.

**Free**

Send coupon  
for these two  
factual book-  
lets NOW!



DEVRY TECHNICAL INSTITUTE  
4141 Belmont Avenue, Chicago, Ill., 60641 Dept. RE-7-W

Please give me your two free booklets, "Pocket Guide to Real Earnings," and "Electronics in Space Travel"; also include details on how to prepare for a career in Electronics. I am interested in the following opportunity fields (check one or more):

- |  |   |
|--|---|
| <input type="checkbox"/> Space & Missile Electronics | <input type="checkbox"/> Communications         |
| <input type="checkbox"/> Television and Radio        | <input type="checkbox"/> Computers              |
| <input type="checkbox"/> Microwaves                  | <input type="checkbox"/> Broadcasting           |
| <input type="checkbox"/> Radar                       | <input type="checkbox"/> Industrial Electronics |
| <input type="checkbox"/> Automation Electronics      | <input type="checkbox"/> Electronic Control     |

Name \_\_\_\_\_ Age \_\_\_\_\_

Address \_\_\_\_\_ Apt. \_\_\_\_\_

City \_\_\_\_\_ State \_\_\_\_\_ Zip \_\_\_\_\_  
Code \_\_\_\_\_

Check here if you are under 16 years of age.

HOME STUDY AND RESIDENT SCHOOL TRAINING  
AVAILABLE IN CANADA

2103

**DEVRY TECHNICAL INSTITUTE**

4141 Belmont Avenue • Chicago, Illinois 60641

Accredited Member of National Home Study Council

Circle 9 on reader's service card

**FLOATING ELECTRONIC LAB PROBES DEEP-SEA SECRETS**



The Oceanographer, largest ship ever built in the United States for deep-sea surveys and research, has been turned over to the government for fitting out with \$½ million worth of electric equipment. It is the most advanced vessel of its kind in the world. The apparatus on board will measure and record ambient light, the ship's course and speed, magnetic field intensity, gravity, surface current, temperatures at different levels, and ocean depth.

A special feature of the new ship is a Westinghouse 510 computer, which will process geophysical, oceanographic, hydrographic and meteorological data, and log the position of the ship continuously. Thus, sorting and analyzing data collected on the voyage—work

that in the past often took months—will be done immediately. This will permit the Coast and Geodetic Survey to produce more data at a lower cost and a tremendous saving in time.

The same computer will be used to operate the ship as well. Propulsion and other machinery is automated. An alarm system detects and locates malfunctions, gives a warning signal and types out a description of the problem. Automated centralized engine control, when fully developed, may permit a single operator to monitor and control a ship's engineering plant from a central station. [Editor's note: Be sure to see the article on deep-sea electronics that will be one of the features of next month's issue.]

to the customer per month would be some \$50 plus telephone line charges, and an extra charge of 2.5 cents per minute for every page over 100 pages per month. It operates at a rate of about 6 minutes for a standard typewriter-size page.

*Telephone Digest* points out that since the 'device works on the extremely narrow bandwidth of a telephone line, this means that facsimile pictures and copy could be transmitted to masses of machines over any AM radio station, or multiplexed into an FM signal. Magnafax itself probably is not the answer to consumer market—but its low cost and economical bandwidth requirements show how close we're getting to a 'home electronic publishing center' and all it implies."

This would make a reality of RAFAR (Radio Automated Facsimile

**Radio-Electronics Adopts Hertz**

RADIO-ELECTRONICS is now using the term *hertz* in place of cycles in all references to frequency. Hz, kHz and MHz, abbreviations for hertz, kilohertz and megahertz, are replacing cycles, kc and mc in all recently edited material.

and Reproduction) proposed by Hugo Gernsback in the March 1963, RADIO-ELECTRONICS.

**LASER NOW USED AS INTRUSION DETECTOR**

An invisible electronic fence to guard warehouses, private estates, tank farms, airstrips, military camps, has been introduced by Raytheon's engineers. Small, lightweight transmitters



*A Raytheon Company guard puts the "lid" on an area by lining up the intrusion detector transmitter with a removeable rifle scope. The Lid is Raytheon's name for a laser-intrusion detector.*

# Radio-Electronics

154 WEST 14TH STREET  
NEW YORK 10011

- HUGO GERNSBACK, *editor-in-chief*
- M. HARVEY GERNSBACK, *publisher*
- FOREST H. BELT, *editor*
- Bruce Ward, *production manager*
- Robert F. Scott, W2PWG, *technical editor*
- Peter E. Sutheim, *associate editor*
- Jack Darr, *service editor*
- I. Queen, *editorial associate*
- Wm. Lyon McLaughlin, *technical illustration director*
- Helen Parker, *editorial assistant*
- Patricia Mitchell, *production assistant*
- G. Aliquo, *circulation manager*
- Joseph L. Bund, *newsstand director*
- Cover design by Harry Schlack

RADIO-ELECTRONICS is published by Gernsback Publications, Inc. Chairman of the Board: Hugo Gernsback President: M. Harvey Gernsback Vice President-Secretary: G. Aliquo Vice President-Treasurer: Charles A. Raible

**ADVERTISING REPRESENTATIVES**

- EAST**  
John J. Lamson, Eastern Sales Manager, RADIO-ELECTRONICS, 154 West 14th Street, New York 10011, 212-255-7755
- MIDWEST**  
P. H. Dempers Co., 5555 N. Lincoln Ave., Chicago, Ill. 60625, 312-561-0220
- SOUTH CENTRAL**  
Media Representatives, Inc., 7900 Carpenter Freeway, Dallas, Texas 75247, 214 ME 1-4480
- WEST COAST**  
J. E. Publishers Representative Co., 8380 Melrose Ave., Los Angeles, Calif. 90069, 213-653-5841; 420 Market St., San Francisco, Calif. 94111, 415-981-4527

**UNITED KINGDOM**  
Publishing & Distributing Co., Ltd., Mitre House, 177 Regent St., London W.1, England  
**SUBSCRIPTION SERVICE:** Send all subscription correspondence and orders to RADIO-ELECTRONICS, Subscription Department, Boulder, Colo. 80302. For change of address, allow six weeks, furnishing both the old and new addresses and if possible enclosing label from a recent issue.

**MOVING?** Or writing about subscription? Be sure to fill out form below.

For FASTEST service on address change, missing copies, etc., attach old mailing label in first space below. Otherwise please print clearly your address as we now have it.

OLD ADDRESS (Attach old label if available)

Name .....

Address .....

City ..... State .....

Zip Code .....

**NEW ADDRESS**

Name .....

Address .....

City ..... State .....

Zip Code .....

Mail to: **RADIO-ELECTRONICS**  
Subscription Dept. Boulder, Colo. 80302

RADIO-ELECTRONICS



**COLUMBIA  
STEREO TAPE CLUB**  
now offers you

**ANY 4  
STEREO TAPES**

**\$5.98**  
FOR ONLY

Value up to \$31.80  
at regular Club prices

If you join the Club now and agree to purchase as few as 5 selections in the next 12 months, from the more than 200 to be offered

**FREE** if you join now  
**REVOLUTIONARY SELF-THREADING TAKE-UP REEL**



Just drop the end of the tape over this reel, start your recorder, and watch it thread itself! Unique Scotch® process automatically threads up tape of any thickness, releases freely on rewind.

**MORE GENIUS OF JANKOWSKI**  
Canadian Sunset • Heide Sunrise Serenade  
9 MORE  
COLUMBIA

2350. Also: Charming Vienna, A Walk in Bavaria, etc.

**HAPPINESS IS RAY CONNIF**  
his SINGERS and ORCHESTRA  
Blue Moon  
All by Myself  
10 MORE  
COLUMBIA

2398. Also: Melodie D'Amour, Jamaica Farewell, etc.

**BROADWAY BOUQUET**  
The Magnificent Strings of Percy Faith  
COLUMBIA

2161. Long Ago, Make Someone Happy, Who Can I Turn To, etc.

The Wonderful World of Antonio Carlos Jobim  
COLUMBIA

2178. Bonita, She's A Carioca, Dindi, Surfboard, 8 more

Trumpets' Greatest Hits **BOBBY HACKETT**  
And the Angels Sing  
Java  
10 MORE  
REPRISE

2327. Also: Ciribiribin, Sugar Blues, O Mein Papa, etc.

**THIS TIME BY BASIE**  
Hits of the 50's and 60's!  
Fly Me To The Moon  
Plus I Can't Stop Loving You  
Walk, Don't Run  
REPRISE

2112. Also: One Mint Julep, Nice 'N' Easy, Moon River, etc.

**JOHNNY MATHIS**  
THE SWEETHEART TREE  
• Danny Boy  
• Autumn Leaves  
9 MORE  
REPRISE

2291. Also: This Is Love, Symphony, I'll Close My Eyes, etc.

**BELOVED CHORUSES, Vol. 2**  
Mormon Tabernacle Choir  
Philadelphia Orchestra  
Music of Bach, Beethoven, Schubert, Grieg, others  
COLUMBIA

2264. "Heartily recommended."—American Record Guide

**ROGER MILLER'S GOLDEN HITS**  
England Swings  
King of the Road  
Dang Me  
9 MORE  
SMASH

2278. Also: Kansas City Star, In The Summertime, etc.

**GROFE: GRAND CANYON SUITE**  
Bernstein N.Y. Philharmonic  
COLUMBIA

1645. Delightful performance of Grofe's soaring tone poem

**THE 4 SEASONS**  
Gold Vault of Hits  
Dawn (Go Away)  
Let's Hang On  
Rag Doll  
9 MORE  
PHILIPS

2403. Also: Big Man In Town, Toy Soldier, Ronnie, etc.

**SERKIN • BEETHOVEN**  
Three Favorite Sonatas  
MOONLIGHT • PATHETIQUE  
APPASSIONATA  
COLUMBIA

1263. "Magnificent performance!"—High Fidelity

**ROBERT GOULEY ON BROADWAY**  
HELLO, DOLLY!  
PEOPLE  
10 more  
COLUMBIA

2268. Also: Who Can I Turn To; Long Ago; Sunrise, Sunset; etc.

**WILLIAM TELL**  
and Other Favorite Overtures  
LEONARD BERNSTEIN  
NEW YORK PHILHARMONIC  
COLUMBIA

2267. "Stunning, with staggering articulation!"—High Fidelity

**FERRANTE & TEICHER ONLY THE BEST**  
Downtown • Chim Chim  
Cher-ee • 10 more  
COLUMBIA

2236. Also: Half A Sixpence, Fiddler On The Roof, etc.

**TCHAIKOVSKY: THE NUTCRACKER • SWAN LAKE (Suites)**  
ORMANDY  
PHILADELPHIA ORCHESTRA  
COLUMBIA

2405. "Exciting, sensuous romanticism."—N. Y. Times

**ROGER WILLIAMS plays THE HITS**  
Dear Heart • Mr. Lonely  
People  
9 more  
COLUMBIA

2077. Also: Willow Weep For Me, Frenesi, Try To Remember, etc.

**PHILIPPE ENTREMONT**  
Saint-Saens  
Piano  
Concertos Nos. 2 & 4  
EUGENE ORMANDY  
PHILADELPHIA ORCH.  
COLUMBIA

2217. Glittering performances of these two charming works

**THE WANDERING MINSTRELS**  
New Christy Minstrels  
The Girl from Ipanema  
Wimoweh  
10 MORE  
COLUMBIA

2222. Also: Tie Me Kangaroo Down, Sport; etc.

**THE MOVIE SONG ALBUM**  
**TONY BENNETT**  
Song from "The Oscar"  
Emily  
10 MORE  
COLUMBIA

2404. Also: Never Too Late, The Pawnbroker, Smile, etc.

**SPECTACULARS!**  
by Tchaikovsky  
Offenbach, others  
EUGENE ORMANDY  
PHILADELPHIA ORCHESTRA  
COLUMBIA

2244. Thirteen dazzling showpieces — played with fire

**JOAN BAEZ**  
FAREWELL ANGELINA  
plus Satisfied Mind  
Colours  
8 MORE  
VANGUARD

2409. Also: The Wild Mountain Thyme, Puvre Ruteboef, etc.

**PETER PAUL & MARY**  
See What Tomorrow Brings  
• Early Mornin' Rain  
• If I Were Free  
10 MORE  
WARNER BROS.

2225. Also: Jane, Jane; The Rising of The Moon; etc.

**VIVALDI THE FOUR SEASONS**  
Leonard Bernstein  
N. Y. PHILHARMONIC  
John Corigliano  
VIOLIN  
COLUMBIA

2213. Baroque masterpiece—in a masterful performance

HERE'S A FABULOUS OFFER from the world-famous Columbia Stereo Tape Club... an exceptional offer that allows you to build an outstanding collection of superb stereo tapes at great savings!

Yes, by joining now you may have ANY FOUR of the magnificently recorded 4-track stereo tapes described here — sold regularly by the Club for up to \$31.80 — for only \$5.98!

TO RECEIVE YOUR 4 PRE-RECORDED STEREO TAPES FOR ONLY \$5.98 — simply fill in and mail the coupon at the right. Be sure to indicate the type of music in which you are mainly interested: Classical or Popular.

HOW THE CLUB OPERATES: Each month the Club's staff of music experts chooses a wide variety of outstanding selections. These selections are described in the entertaining and informative Club magazine which you receive free each month.

You may accept the monthly selection for the field of music in which you are primarily interested... or take any

of the wide variety of other tapes offered by the Club... or take NO tape in any particular month.

Your only membership obligation is to purchase 5 tapes from the more than 200 to be offered in the coming 12 months. Thereafter, you have no further obligation to buy any additional tapes... and you may discontinue your membership at any time.

FREE TAPES GIVEN REGULARLY. If you wish to continue as a member after purchasing five tapes you will receive — FREE — a 4-track stereo tape of your choice for every two additional tapes you buy from the Club.

The tapes you want are mailed and billed to you at the regular Club price of \$7.95 (occasional Original Cast recordings somewhat higher), plus a small mailing and handling charge.

SEND NO MONEY — Just mail the coupon today to receive your four pre-recorded 4-track stereo tapes for only \$5.98!

Note: All tapes offered by the Club must be played back on 4-track stereo equipment.

**COLUMBIA STEREO TAPE CLUB • Terre Haute, Indiana**

**SEND NO MONEY — JUST MAIL COUPON!**

COLUMBIA STEREO TAPE CLUB, Dept. 406-4  
Terre Haute, Indiana 47808

**SEND ME THESE FOUR TAPES**  
(fill in numbers below)

I accept your special offer and have written in the boxes at the right the numbers of the 4 tapes I would like to receive for \$5.98, plus a small mailing and handling charge. I will also receive my self-threading take-up reel — FREE!

My main musical interest is (check one):

CLASSICAL

POPULAR

I understand that I may select tapes from any field of music. I agree to purchase five selections from the more than 200 to be offered in the coming 12 months, at the regular Club price plus a small mailing and handling charge. Thereafter, if I decide to continue my membership, I am to receive a 4-track, pre-recorded tape of my choice FREE for every two additional selections I accept.

Print Name..... First Name..... Initial..... Last Name.....

Address.....

City.....

State..... Zip Code.....

This offer is available only within the continental limits of the U.S.

48-TG

**"... one of the finest stereo FM tuners we have tested and... easily the best kit-built tuner we have checked."**

Hi Fi/Stereo Review April 1966



**"The Scott LT-112 met or exceeded all its specifications that we were able to check. Its sensitivity was 2.1 microvolts (rated 2.2). Harmonic distortion at 100 per-cent modulation was about 0.5 percent (rated 0.8 per-cent). Capture ratio was 2.4 db (rated 4 db). Hum was -66 db, which is the lowest we have ever measured on a tuner . . . it is a logical choice for anyone who wants the finest in FM reception at a most reasonable price."**

**Build the stereo tuner that has won rave reviews from audio experts . . . the Scott LT-112. Here are the same features, performance, quality, and reliability you'd expect from Scott's finest factory-wired solid-state tuners . . . the only difference is, you build it. LT-112 price, \$179.95.**



For complete information on the Scott LT-112 solid-state FM Stereo tuner kit, write: H. H. Scott, Inc., Dept. 570-07, 111 Powdermill Road, Maynard, Mass. Export: Scott International, Maynard, Mass. Prices and specifications subject to change without notice. Prices slightly higher west of Rockies.

Circle 19 on reader's service card

The story  
of your career  
in electronics  
surely hasn't been  
written yet.



But you may find the preface  
to it on page 63



and receivers, each housed in a 1-inch tube only 15 inches long, are used to send and receive a pulsed beam around the area to be guarded. A beam 1 mile long can be produced, and can be reflected around a building, for example, with mirrors.

The laser has a great advantage over photoelectric detection devices using ordinary light. The laser beam is absolutely invisible to the naked eye and much narrower than a beam of incoherent light. Thus the electronic fence would be virtually impossible to see or jam. Since the pulses are regularly spaced, objects of different sizes or moving at different speeds, have different interruption patterns, giving the experienced operator information about the type of intrusion. For example, a man sneaking slowly past would give an entirely different signal from a loaded truck moving at moderate speed.

#### **AUTO CARTRIDGE STANDARDS**

##### **SET UP TENTATIVELY**

Standards for auto tape cartridges of the type used by Fidelipac, Lear Jet and Nortronics, are being worked on by an Electronic Industries Association committee, headed by RCA Victor's H. E. Roy. The standards will describe the dimensions and areas of cartridges, the head position and other characteristics that may enter into the problem of cartridge interchangeability.

#### **BRIEF BRIEF**

International Telephone & Telegraph Corp. (ITT) and Howard W. Sams & Co., Inc. have settled terms under which Sams will join the ITT system, if Sams stockholders approve. The merger between American Broadcasting Co. and ITT, proposed earlier this year, has been approved by ITT stockholders.

END

#### **CALENDAR OF EVENTS**

3rd Congress of International Federation of Automatic Control, June 20-25; London, England.

NCTA (National Community Television Assn.), June 27-30; Americana Hotel, Bal Harbor (Miami Beach), Fla.

Aerospace Systems Conference, July 11-15; Olympic Hotel, Seattle, Wash.

NATESA (National Alliance of Television and Electronic Service Associations) Convention, July 24-27; Chicago, Ill.

Automatic Controls Conference, Aug. 17-19; University of Washington, Seattle, Wash.

WESCON (Western Electronic Show and Convention), Aug. 23-26; Sports Arena, Los Angeles, Calif.

Some plain talk from Kodak about tape:

## The binder that ties things together... and how to sound in the pink

"La sauce, c'est tout,"—the sauce is everything, say the French. An oversimplification perhaps. Still, as far as sound recording tape goes, the sauce—our "R-type" binder—counts for a lot. First off, there must be a mutual affinity between binder and oxide. It must be a good oxide mixer, while still keeping individual oxide particles at arm's length, you might say. Of course, fast drying, superior chemical stability, and a dozen other mechanical and chemical properties are a must. One very interesting point involves the "R-type" binder's extremely interesting viscosity characteristics . . .

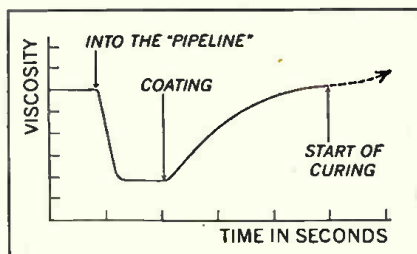

"R-type" Binder Viscosity Graph

**A Sticky Problem.** Familiar with no-drip house paints? They're thick in the can . . . thin when you apply them (for low effort) . . . yet thicken again as soon as applied, so they won't drip. Somewhat the same thing has to happen when one applies the binder-oxide mix to the tape backing. It's got to go on smoothly—low viscosity . . . then it's got to stay put—high viscosity. To thicken the plot, once the coating is on, the tape is passed through a very strong magnetic field to physically align the oxide particles—low viscosity again. Once aligned, the particles have got to stay locked in "at attention!"—high viscosity. That's asking a lot of a binder. And ours delivers.

**It's loaded.** Our "R-type" binder not only gives you a more disciplined, smoother, more efficient oxide layer . . . but it allows us to incorporate a high oxide density in the magnetic dispersion. High output is the "proof" of this density. That's why KODAK Tapes give you from 1 to 3 db extra output compared to equivalent competitive tapes.

**Pink noise testing** . . . or how hi-fi is your room? Room acoustics certainly color the sound you hear . . . may even produce effects you have ascribed to electronics. Take test tapes, for example. They frequently make use of pure tones, even pure sine waves that easily go through your amplifier yet give a most confusing impression in your sound-level meter or ears. The culprit? Standing waves caused by hard parallel surfaces—like walls, floor and ceiling—which reflect the sound back and forth. At the point of reinforcement, the sound is loud; at the null point, it's low. What to do? Persian wall-hangings, bearskin rugs and soft rounded forms—if you're lucky enough—help keep standing waves down. But to develop the very best in KODAK Sound Recording Tapes, our engineers turn to "pink noise" testing.

**Why pink?** Unlike pure tones that



make for easy instrumentation, musical sounds are complex—very similar to narrow bands of "white noise." But a white noise generator produces a mixture of all possible tones with equal energy-per-unit frequency. By breaking this white noise down into one-third octave bands of equal energy, we can study portions of the sound spectrum separately, yet have sound waves that are sufficiently complex so standing waves no longer confuse the issue. We call this type of white noise "pink." We're working on a practical simplification that will let you do something of this sort for your



own checkout. But meanwhile, relax to the music of KODAK Tape, secure in the knowledge that it is even "Pink Noise Tested!"

KODAK Tapes—on DUROL Base and polyester base—are available at most electronic, camera, and department stores. To get the most out of your tape system, send for free, 24-page "Plain Talk" booklet which covers the major aspects of tape performance. Write: Dept. 940, Eastman Kodak Company, Rochester, N. Y. 14650.

EASTMAN KODAK COMPANY, Rochester, N.Y.

Circle 12 on reader's service card

One of a series of brief discussions  
by Electro-Voice engineers

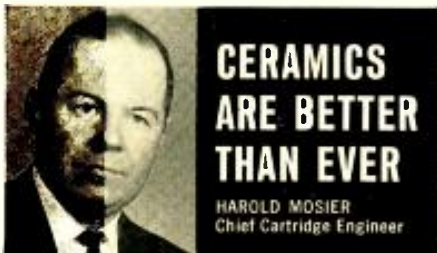

Since the advent of stereo, improvements in console and portable phonographs have raised the quality and value of this equipment to the user to heights undreamed of—even by component high fidelity manufacturers—just a few short years ago.

Perhaps most dramatic have been the advances in phono cartridge design for this equipment. The modern E-V ceramic cartridge used in many of today's better stereo consoles rivals the most sophisticated magnetic types in reproduction quality. Yet, despite the improved performance, this new generation of ceramic cartridges better withstands the accidental abuse so often encountered when the entire family uses the phonograph.

The high-compliance, non-destructible needle assembly of E-V cartridges is largely responsible for this improvement. Compliance of  $13 \times 10^{-6}$  cm/dyne is typical of the newest types, yet this cartridge operates modern changer mechanisms with a force of just 2 grams, and will track both vertical and lateral amplitudes as great as .005 cm at less than 1 gram!

This useful high compliance was achieved only after development of a special resolver (yoke) plus long experimentation with materials. The resonance of this needle assembly is damped with controlled impedance to achieve low harmonic distortion and minimum high frequency crosstalk—with consequent improvement in separation. The E-V models offer 30 db separation at 1 kc and 20 db at 10 kc.

Tip mass has also been reduced sharply to minimize high frequency distortion, extend high frequency response, and reduce record wear. And the overall cartridge mass itself has been lowered to under 2 grams. One version of this cartridge becomes—in effect—an extension of the tone arm itself, requiring no shell for protection, but simply plugging into the end of the tone arm to create a uniquely low mass tone arm-cartridge assembly. Other models mount in more conventional fashion with standard dimensions.

Despite this reduction in mass and increase in compliance, sensitivity of E-V ceramic phono cartridges remains high: .3 volt @ 1 kc (velocity = 3.54 cm/sec 45°). This high output permits exact tailoring of frequency response characteristics to the RIAA curve with no need for further equalization. Curves can also be modified to suit the special needs of the phono manufacturer. By every objective criteria the modern ceramic phono cartridge offers an unusually high level of quality for the consumer, plus design flexibility of great value to the phono engineer.

For technical data on any E-V product, write:  
ELECTRO-VOICE, INC., Dept. 763E  
613 Cecil St., Buchanan, Michigan 49107

**Electro-Voice**  
SETTING NEW STANDARDS IN SOUND

# Correspondence

## NOTEWORTHY APPRECIATION

Dear Editor:

I would like to express appreciation for the Noteworthy Circuits on page 100 of the January 1966 issue. I have incorporated the bias circuit and ECLL800 tubes in an amplifier I built two years ago. Amazing results. Try it.

BRUCE J. ERICKSON

Newton, Mass.

## SUPERSTIMULATOR

Dear Editor:

Enclosed is a photo I thought might interest you. It is my deluxe model of the Muscle Stimulator described in your June 1965 issue. I elaborated somewhat on the original: provided separate controls for additional sets of electrodes and incorporated a surge circuit which can be alternated between two sets of pads.



I think this little machine is great and thank you for it. I have had considerable back trouble for 30 years and can honestly say this machine has given me much comfort.

I would be interested in finding a circuit for a small diathermy unit.

EDWARD A. BOLLINGER

N. Miami Beach, Fla.

[Readers: anyone built a diathermy machine?—Editor]

## BELGIAN CURVES

Dear Editor:

Fred Blechman's component curve tracer is the type of gadget we readers hope to find when opening RADIO-ELECTRONICS. So, the same day your November 1965 issue came, I built the tracer. The most wonderful surprise is that the

curves are exactly like those on page 53.

I later added the decimal attenuator and calibration potentiometer shown

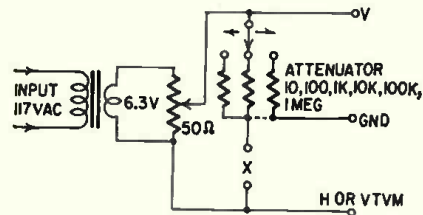

here, so I could use the unit as a simple RLC ohmmeter, a vtm taking the place of the horizontal input of a scope.

ANDRE BENY

Soignies, Belgium

## 1.8 DEKAGHELARDIS OF CRITICISM

Dear Editor:

If the National Bureau of Standards persists in its appalling tendency to substitute commemorative names such as *hertz* for more descriptive terms such as *cycles per second*, there is no end to the mischief that may yet be wrought.

We may some day speak of an auto speeding along smartly at 60 *ford*s. Marine boiler pressure gauges may yet be calibrated, without folly, in *fultons* instead of *pounds per square inch*.

Many of the earliest men of science yet to be remembered. *Gallons per minute (gpm)* has been around too long. That great hydraulic engineer, Archimedes, could be substituted here. And, of course, 1,000, *gpm* would henceforth be known as a *kiloarchimedes!*

RAYMOND P. GHELARDI

Brooklyn, N.Y.

[Or *kiloarcs*, for short! Then, color phase can be measured in *sarnoffs*, FM side-band pairs calculated in *armstrongs*, science fiction stories told in *gernsbacks* (or *hugos*), and a 10-inch column of copy in a magazine could be known as an . . .

—Editor]

## MINOR TRIMMINGS TO AUDIO TVM

Dear Editor:

I have just completed the ac transistor voltmeter (March 1966, page 36) and find it very accurate. R17 in my unit

*continued on page 16*

## Poor Man's Digital Voltmeter

Here's a valuable piece of test equipment you can build for less than \$65 from all-new components, or for less than \$20 with a little shopping and some help from the junk box. While the PMDVM does not claim the accuracy of factory-built lab-type digital voltmeters, it will serve you well in many shop and experimenter applications.

See it, build it from plans in August Test Instrument Special Issue of RADIO-ELECTRONICS

RADIO-ELECTRONICS

# New Professional DC Scope Kit<sup>®</sup> 10-14

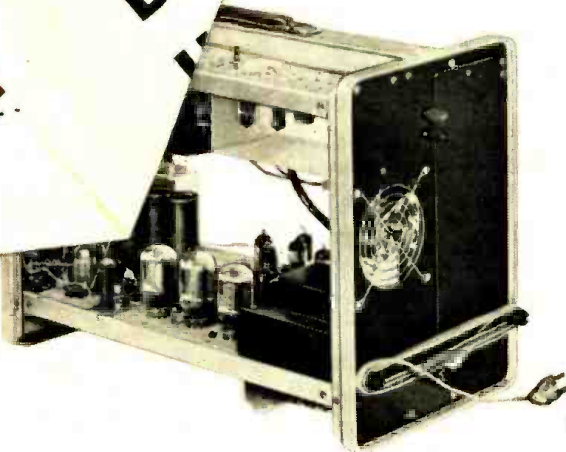

Kit **\$299**  
Factory Assembled **\$399**



Eighteen Years Ago Heath Broke The Price Barrier On Oscilloscopes With A Low-Cost Scope For Hams, Hobbyists, And Service Technicians. Now Heath Breaks The Price Barrier Again! . . . With A Precision, Fast-Response, Triggered Sweep, Delay Line Oscilloscope For The Serious Experimenter, Industrial Or Academic Laboratory, And Medical Or Physiology Research Laboratory.

- A high stability 5" DC oscilloscope with triggered sweep • DC to 8 mc bandwidth and 40 nanosecond rise time • Vertical signal delay through high linearity delay lines—capable of faithful reproduction of signal waveforms far beyond the bandwidth of the additional circuitry • Calibrated vertical attenuation—from 0.05 v/cm to 600 volts P-P maximum input • Calibrated time base • 5X sweep magnifier • Forced air cooling • Input for Z axis modulation • Input for direct access to vertical deflection plates • Easy circuit-board construction & wiring harness assembly • Components are packaged separately for each phase of construction • Easy to align • Fulfills many production and laboratory requirements at far less cost than comparable equipment—particularly scopes capable of fast-rise waveform analysis • No special order for export version required—wiring options enable 115/230 volt, 50-60 cycle operation

Here Is A Truly Sophisticated Instrument . . . designed with modern circuitry, engineered with high quality, precision-tolerance components, and capable of satisfying the most critical demands for performance. The IO-14 features precision delay-line circuitry to allow the horizontal sweep to trigger "ahead" of the incoming vertical signal. This allows the leading edge of the signal waveform to be accurately displayed after the sweep is initiated.

The IO-14 Provides Features You Expect Only In High Priced Oscilloscopes. For example, switches are quality, ball-detent type; all major control potentiometers are precision, high-quality sealed components; all critical resistors are 1% precision; and circuit boards are low-loss fiber glass laminate. The IO-14's cabinet is heavy gauge aluminum. Its CR tube is shielded against stray magnetic fields, and forced air ventilation allows the IO-14 to be operated under the continuous demands of industrial and laboratory use.

Kit IO-14, 45 lbs. . . . . **\$299.00**  
Assembled IO-14, 45 lbs. . . . . **\$399.00**

**IO-14 SPECIFICATIONS**—(Vertical) Sensitivity: 0.05 v/cm AC or DC. Frequency response: DC to 5 mc, —1 db or less; DC to 8 mc, —3 db or less. Rise time: 40 nsec (0.04 microseconds) or less. Input impedance: 1 megohm shunted by 15 uuf. Signal delay: 0.25 microsecond. Attenuator: 9-position, compensated, calibrated in 1, 2, 5 sequence from 0.05 v/cm. Accuracy:  $\pm 3\%$  on each step with continuously variable control (uncalibrated) between each step. Maximum input voltage: 600 volts peak-to-peak; 120 volts provides full 6 cm pattern in least sensitive position. (Horizontal) Time base: Triggered with 18 calibrated rates in 1, 2, 5 sequence from 0.5 sec/cm to 1 microsecond/cm with  $\pm 3\%$  accuracy or continuously variable control position (uncalibrated). Sweep magnifier: X5, so that fastest sweep rate becomes 0.2 microsecond/cm with magnifier on. (Overall time base accuracy  $\pm 5\%$  when magnifier is on.) Triggering capability: Internal, external, or line signals may be switch selected. Switch selection of + or — slope. Variable control on slope level. Either AC or DC coupling. "Auto" position. Triggering requirements: Internal;  $\frac{1}{2}$  cm to 6 cm display. External: 0.5 volts to 120 volts peak-to-peak. Horizontal input: 1.0 v/cm sensitivity (uncalibrated) continuous gain control. Bandwidth: DC to 200 kc  $\pm 3$  db. General 5ADP31 or 5ADP2 Flat Face C.R.T. interchangeable with any 5AD or 5AB series tube for different phosphor characteristics. 4250 V. accelerating potential. 6 x 10 cm edge lighted graticule with 1 cm major divisions & 2 mm minor divisions. Power supply: All voltages electronically regulated over range of 105-125 VAC or 210-250 VAC 50/60 cycle input. (Z Axis) Input provided. DC coupled CRT unblanking for complete retrace suppression. Power requirements: 285 watts. 115 or 230 VAC 50-60 cps. Cabinet dimensions: 15" H x 10 1/2" W x 22" D includes clearance for handle and knobs. Net weight: 40 lbs.

## FREE! 1966 Heathkit Catalog



108 pages . . . many in full color . . . describe over 250 Heathkits for the lab, hobbyist, and industry.

Heath Company, Dept. 20-7  
Benton Harbor, Michigan 49022

- Enclosed is \$ \_\_\_\_\_, plus shipping for model (s) \_\_\_\_\_  
 Please send FREE Heathkit Catalog & full IO-14 specifications.

Name \_\_\_\_\_

Address \_\_\_\_\_

City \_\_\_\_\_ State \_\_\_\_\_ Zip \_\_\_\_\_

Prices & specifications subject to change without notice.

TE-142

Circle 13 on reader's service card

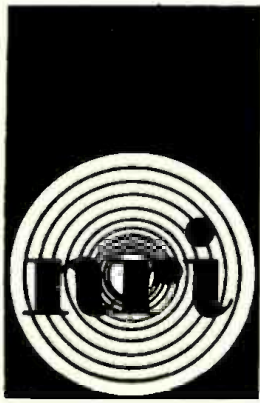

# ***Learning electronics at home is faster, easier, more interesting with new achievement kit***

Only NRI offers you this pioneering method of "3 Dimensional" home-study training in Electronics, TV-Radio . . . a remarkable teaching idea unlike anything you have ever encountered. Founded more than half a century ago—in the days of wireless—NRI pioneered the "learn-by-doing" method of home-study. Today, NRI is the oldest, largest home-study Electronics school. The NRI staff of more than 150 dedicated people has made course material entertaining and easy to grasp. NRI has simplified, organized and dramatized subject matter so that any ambitious man—regardless of his education—can effectively learn the Electronics course of his choice.

## **DISCOVER THE EXCITEMENT OF NRI TRAINING**

Whatever your reason for wanting knowledge of Electronics, you'll find the NRI "3 Dimensional" method makes learning exciting, fast. You build, test, experiment, explore. Investigate NRI training plans, find out about the NRI Achievement Kit. Fill in and mail the postage-free card. No salesman will call. NATIONAL RADIO INSTITUTE, Electronics Division, Washington, D. C. 20016

## **GET A FASTER START COURSE YOU CHOOSE REMARKABLE ACHIEVEMENT.**

When you enroll with NRI we deliver everything you need to make a significant in the Electronics field of your choice. A remarkable, new starter kit is worth many times the small down payment required to start your training. And it is only the start . . . only the first example of NRI's unique ability to apply 50 years of home-study experience to the challenges of this Electronics Age. Start your training the exciting, rewarding way. No other school has anything like it. What do you get? The NRI Achievement Kit includes: your first set of easy-to-understand "bite-size" texts; a rich, vinyl desk folder to hold your training material in order fashion; the valuable NRI Radio-TV Electronic Dictionary; important reference texts; classroom tools like pencils, a ball-point pen, an engineer ruler; special printed sheets for your lesson answers—even a supply of pre-addressed envelopes and your first postage stamp.



## **ELECTRONICS COMES ALIVE AS YOU LEARN BY DOING WITH CUSTOM TRAINING EQUIPMENT**

Nothing is as effective as learning by doing. That's why NRI puts so much emphasis on equipment, and why NRI invites comparison with equipment offered by any other school, at any price. NRI pioneered and perfected the use of special training kits to aid learning at home. You get your hands on actual parts like resistors, capacitors, tubes, condensers, wire, transistors and diodes. You build, experiment, explore, discover. You start right out building your own professional vacuum tube voltmeter with which you learn to measure voltage and current. You learn how to mount and solder parts, how to read schematic diagrams. Then, you progress to other experimental equipment until you ultimately build a TV set, an actual transmitter or a functioning computer unit (depending on the course you select). It's the practical, easy way to learn at home—the priceless "third dimension" in NRI's exclusive Electronic TV-Radio training method.

## **SIMPLIFIED, WELL-ILLUSTRATED "BITE-SIZE" LESSON TEXTS PROGRAM YOUR TRAINING**

Certainly, lesson texts are a necessary part of training . . . but only a part. NRI has reduced reading matter to "bite-size," programmed texts as simplified, direct and well-illustrated as half a century of teaching experience can make them. The best scientific techniques and extensive study have gone into each book. The amount of material in each text, the length and design, is precisely right for home-study. NRI texts are programmed with NRI training kits to make things you read about come alive. As you learn, you'll experience all the excitement of original discovery. Texts and equipment vary with the course you select. Choose from three major training programs in TV-Radio Servicing, Industrial Electronics and Complete Communications. Or select one of seven specialized courses for men with specific wants or needs. Check the courses of most interest to you on the postage-free card and mail it today for your free catalog.

# ***custom training kits "bite-size" texts***



# WHY risk your reputation with "just-as-good" capacitors?

When you pay little or no attention to quality in tubular replacement capacitors, you leave yourself wide open for criticism of your work . . . you risk your reputation . . . you stand to lose customers. It just doesn't pay to take a chance on capacitors with unknown or debatable performance records when it's so easy to get guaranteed dependable tubulars from your Sprague distributor!

## There's no "maybe" with these 2 great SPRAGUE DIFILM® TUBULARS!

The ultimate in tubular capacitor construction. Dual dielectric . . . polyester film and special capacitor tissue . . . combines the best features of both. Impregnated with HCX®, an exclusive Sprague synthetic hydrocarbon material which fills every void in the paper, every pinhole in the plastic film *before it solidifies*, resulting in a rock-hard capacitor section . . . there's no oil to leak, no wax to drip. Designed for 105°C (220°F) operation without voltage derating.

### DIFILM® ORANGE DROP® Dipped Tubular Capacitors



A "must" for applications where only radial-lead capacitors will fit . . . the perfect replacement for dipped capacitors now used in many leading TV sets. Double-dipped in rugged epoxy resin for positive protection against extreme heat and humidity. No other dipped tubular capacitor can match Sprague Orange Drops!



### DIFILM® BLACK BEAUTY® Molded Tubular Capacitors

The world's most humidity-resistant molded capacitors. Tough, protective outer case of non-flammable molded phenolic . . . cannot be damaged in handling or installation. Black Beauty Capacitors will withstand the hottest temperatures to be found in any TV or radio set, even in the most humid climates.

For complete listings, get your copy of Catalog C-616 from your Sprague distributor, or write to Sprague Products Company, 81 Marshall Street, North Adams, Massachusetts.



WORLD'S LARGEST MANUFACTURER OF CAPACITORS  
65-0110

Circle 14 on reader's service card

### CORRESPONDENCE continued

had to be lowered to 47K to make the scale linear. Also, on most ranges, 50 kHz is the limit for readings within ½ dB. These are good specs for most audio work.

If anyone finds a small upscale reading on the 0.3- and 1-volt scales this can be corrected by careful dressing of the input lead from S2A's arm and changing the position of the .01-μF input coupling capacitor for minimum reading.

JOSEPH A. KAUFMAN

Union, N.J.

### HAPPY WITH TRANSISTOR IGNITION

Dear Editor:

I built the Zener-less transistor ignition in your September 1964 issue and installed it in a 1960 Meteor Six. Had very good all-around performance: easy starting on cold mornings, point-pitting next to nil, same for plugs.

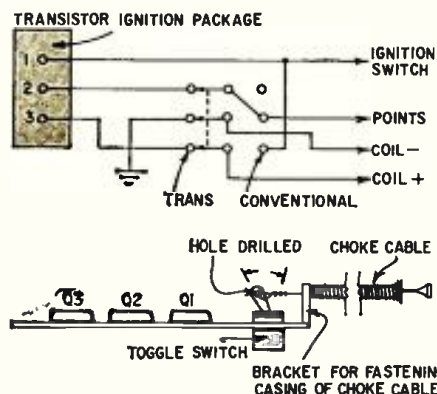

I did add a 3pdt toggle switch in case of transistor failure in traffic. It switches the system back to conventional, and is actuated—without opening the hood—by a choke cable (obtained from automotive parts supplier).

C. J. SYSS

Vancouver, B. C.

END

### Check Your Test Instrument IQ

How well do you know what's happening in the world of test equipment? What are the new developments in scopes, signal generators, voltmeters? How can "Trigsweep" update inexpensive scopes? How will a scope-mobile keep your scope handy and out of the way? What are the best ways to keep an ohmmeter in tip-top shape? Get all the answers in the next RADIO-ELECTRONICS.

Coming your way in  
AUGUST TEST INSTRUMENT  
SPECIAL ISSUE  
of RADIO-ELECTRONICS



“Sure,  
you work hard,  
but that’s not  
enough...”

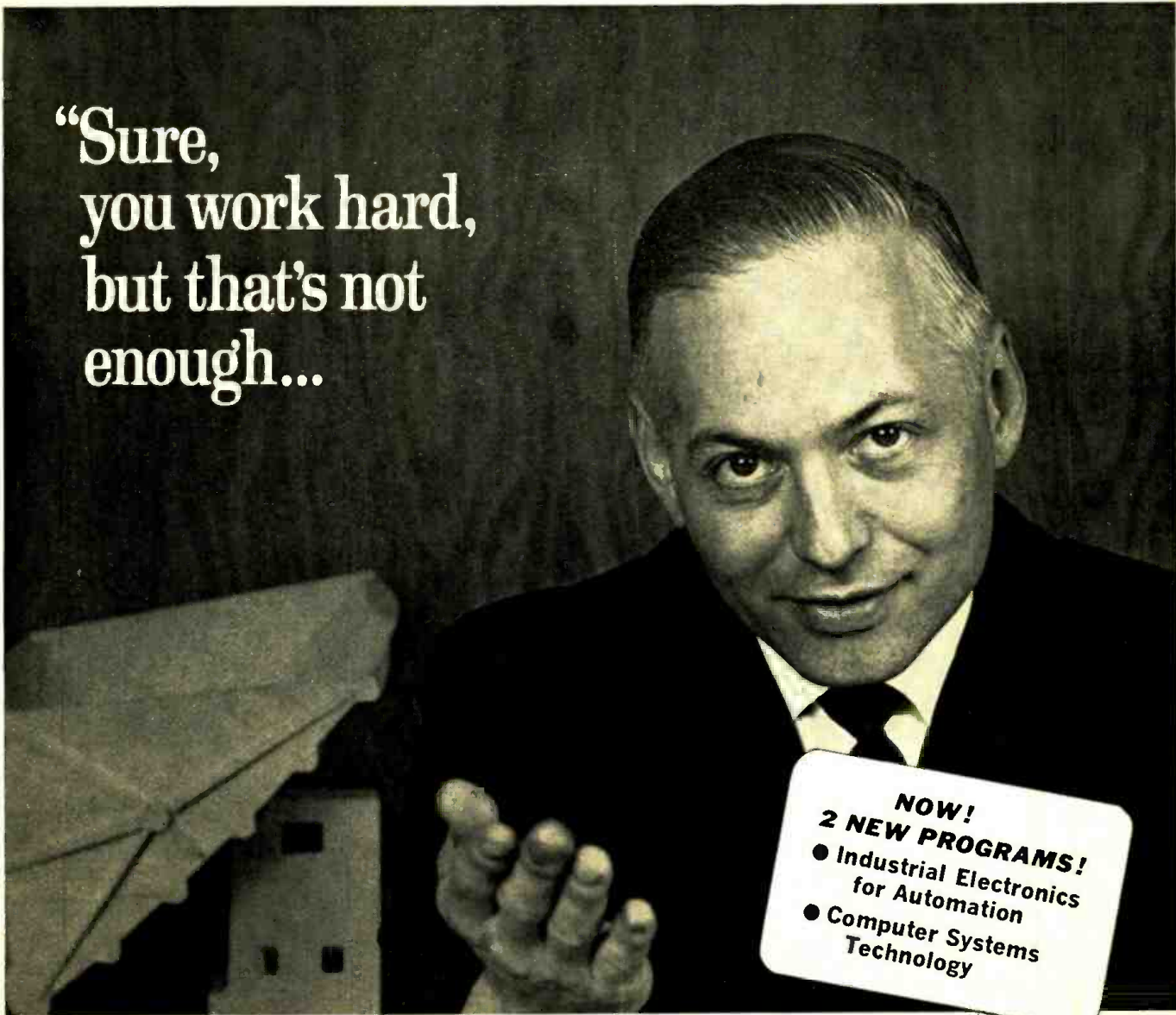

**NOW!  
2 NEW PROGRAMS!**  
● Industrial Electronics  
for Automation  
● Computer Systems  
Technology

...you need more education to get ahead in electronics”

No matter how hard you work, you can't really succeed in electronics without advanced, specialized technical knowledge.

Going back to school isn't easy for a man with a full-time job and family obligations. But CREI Home Study Programs make it possible for you to get the additional education you need without attending classes. You study at home, at your own pace, on your own schedule.

CREI Programs cover all important areas of electronics including communications, servomechanisms, even spacecraft tracking and control. You're sure to find a program that fits your career objectives.

You're eligible for a CREI Program if you have a high school education and work in electronics. Our FREE book gives all the facts. Mail coupon or write: CREI, Dept. 1407-D, 3224 Sixteenth Street, N.W., Washington, D. C. 20010

**SEND FOR FREE BOOK**



Accredited Member of the National Home Study Council



**The Capitol Radio Engineering Institute**  
Dept. 1407-D, 3224 Sixteenth Street, N.W.  
Washington, D.C. 20010

Please send me FREE book describing CREI Programs. I am employed in electronics and have a high school education.

NAME \_\_\_\_\_ AGE \_\_\_\_\_

ADDRESS \_\_\_\_\_

CITY \_\_\_\_\_ STATE \_\_\_\_\_ ZIP CODE \_\_\_\_\_

EMPLOYED BY \_\_\_\_\_  G. I. BILL

TYPE OF PRESENT WORK \_\_\_\_\_

- I am interested in  Electronic Engineering Technology  
 Space Electronics  Nuclear Engineering Technology  
 **NEW! Industrial Electronics for Automation**  
 **NEW! Computer Systems Technology**

# SERVICE CLINIC

By JACK DARR Service Editor

## CURING NEIGHBORHOOD TVI

ONE OF OUR READERS WRITES: "WE LIVE in a fringe area outside New York, and my neighbors and I have a lot of TVI-producing equipment. We'd like to know how to get rid of the interference. We'll make a neighborhood project out of it! Can you tell us how?" A good idea, and a project that should be adopted by

more neighborhoods: Here's how.

Get rid of TVI at its source; squelch the motor or appliance that is making the noise. The first problem is identifying it, of course. Put one man at a TV set, and then turn on every piece of suspected equipment, one at a time. Make a list, or tag each noisy one.

Hallicrafters' new CB-19 transceiver is about as sleek and trim and compact as an infantry boot.



That's why there's room for the "S" meter, the receiver tuning VFO, the king-size communications speaker and unsurpassed basic performance —for only \$149.95



**hallicrafters**

5th and Kostner Aves.  
Chicago, Ill. 60624

Export: International Div. Available in  
Canada through Gould Sales Co.

*"Quality through Craftsmanship"*

Circle 16 on reader's service card

Next, filter them. On a lot of small appliances, you can use simple plug-in filters at the outlet. These take no time at all to install. The simplest of these is just a plug-and-socket device with a .05- $\mu$ F capacitor in it, connected directly across the ac line (Fig. 1). More elaborate ones have chokes in series with each side of the line, and bypass capacitors across it (Fig. 2). Some have an external ground connection for greater effectiveness (Fig. 3).

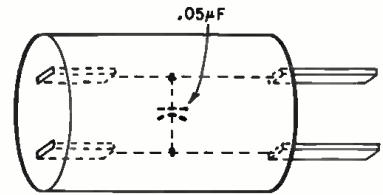

Fig. 1

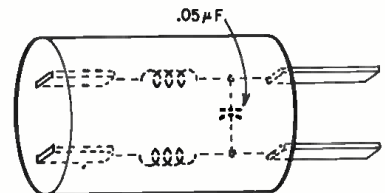

Fig. 2

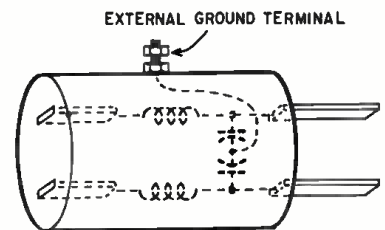

Fig. 3

These filters are available at all radio supply houses, made by Sprague, Cornell-Dubilier, Ohmite, Aerovox and others. The catalogues will give you the exact circuit, type, and so on, for each one. The 'plug-in' type would be hard to build, at home, so the commercial types are cheaper, here.

You can build filters like this, using the basic circuit of Fig. 2 or Fig. 3, for installation inside the cabinets of larger appliances. The chokes can be about 15–20 turns of No. 18 solid wire

This column is for your service problems—TV, radio, audio or general and industrial electronics. We answer all questions individually by mail, free of charge, and the more interesting ones will be printed here.

If you're really stuck, write us. We'll do our best to help you. Don't forget to enclose a stamped, self-addressed envelope. Write: Service Editor, Radio-Electronics, 154 West 14th Street, New York 10011.

# Perfection results from CHOICE...NOT CHANCE

Since no single phono cartridge can be all things to all people, we earnestly recommend that you employ these individual criteria in selecting your personal cartridge from the broad Shure Stereo Dynetic group:

**YOUR EAR:** First and foremost, listen. There are subtle differences in tonality that beggar description and are quite unrelated to "bare" specifications—yet add immeasurably to your personal listening pleasure.

**YOUR EQUIPMENT:** Consider first your tone arm's range of

tracking forces. Too, keep in mind that the cartridge ordinarily represents the smallest monetary investment in the system, yet the ultimate sound delivered depends *first* on the signal reproduced by the cartridge . . . "skimping" here downgrades your entire system.

**YOUR EXCHEQUER:** Shure cartridges cover the entire economic spectrum. And they are ALL Shure in quality, all Shure in performance. Even the least costly has received copious critical acclaim.

## BEST SELLER



**MODEL M3D**

Where cost is the dominant factor, the M3D provides extremely musical and transparent sound at a rock-bottom price. The original, famous Shure Stereo Dynetic Cartridge . . . with almost universal application. Tracks at pressures as low as 3 grams, as high as 6 grams. For any changer. Only \$15.75

## MUSICAL BEST-BUY

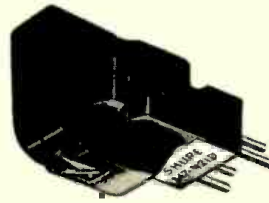

**MODEL M7/N21D**

Top-rated cartridge featuring the highly compliant N21D tubular stylus. Because of unusually clean mid-range (where most music really "happens") it is especially recommended if your present system sounds "muddy." For 2-gram optimum tracking (not to be used over 2½ grams). Only \$17.95 (Also, if you own an M3D or M7D, you can upgrade it for higher compliance, if tracking force does not exceed 2½ grams, with the N21D stylus for only \$12.50.)

## ALL THE MOST WANTED FEATURES

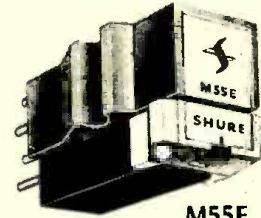

**M55E**

15° TRACKING, ELLIPTICAL STYLUS

Professional performance at a modest price. Compares favorably to the incomparable Shure V-15, except that it is produced under standard Shure quality control and manufacturing techniques. Remarkable freedom from IM, Harmonic and tracing distortion. Will definitely and audibly improve the sound of monaural as well as stereo records. A special value at \$35.50. Upgrade M44 cartridge (if you can track at 1½ grams or less) with N55E stylus, \$20.00

## THE "FLOATING" CARTRIDGE



**M80E GARD-A-MATIC®  
WITH ELLIPTICAL STYLUS**

Bounce-proof, scratch-proof performance for Garrard Lab 80 and Model A70 Series and Dual 1009 automatic turntables. Especially useful where floor vibration is a problem. Spring-mounted in tone arm shell. Stylus and cartridge retracts when force exceeds 1½ grams . . . prevents scratching record and damaging stylus.

Model M80E

For Garrard turntables. \$38.00

Model M80E-D

For Dual 1009 turntables. \$38.00

## THE ULTIMATE!

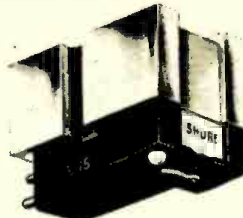

**V-15**

WITH

BI-RADIAL ELLIPTICAL STYLUS

For the purist who wants the very best, regardless of price. Reduces tracing (pinch effect), IM and Harmonic distortion to unprecedented lows. 15° tracking. Scratch-proof, too. Produced under famed Shure Master Quality Control Program . . . literally hand-made and individually tested. In a class by itself for mono as well as stereo discs. For manual or automatic turntables tracking at ¾ to 1½ grams. \$62.50

## "THE BEST PICK-UP ARM IN THE WORLD"



**SHURE SME**

Provides features and quality unattainable in ANY other tone arm. Made by British craftsmen to singularly close tolerances and standards. Utterly accurate adjustments for every critical factor relating to perfect tracking . . . it realizes the full potential of the cartridge and record. Model 3012 for 16" records \$110.50; Model 3009 for 12" records \$100.50

**SHURE**

*Stereo Dynetic®*

High Fidelity Phono Cartridges . . . World Standard Wherever Sound Quality is Paramount  
Shure Brothers, Inc., 222 Hartrey Ave., Evanston, Illinois

Circle 17 on reader's service card

on a 1/4-inch form, and the capacitors can be .01's for the load end and .001's for the line end (Fig. 4). The common connection can be grounded to the case or brought out to an external ground. All connections must be well soldered and taped up to prevent shocks or fire-hazards.

If you don't want to wind coils, you can get them 'ready-made', in all sizes, at the supply house. These are handy, for if you need a higher-inductance coil, the factory-made coils are a lot smaller! Look in the Miller, Merit, and Stancor catalogues, for typical examples.

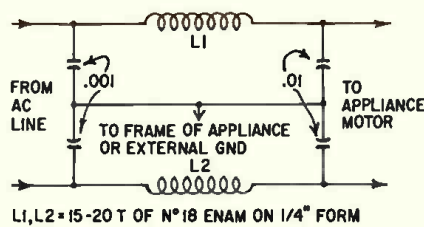

Fig. 4

To quiet small brush-type motors, as in mixers, hair-dryers and such appliances, you can connect .05- $\mu$ F ceramic capacitors directly from each brush ter-

minal to the frame of the motor. The ceramic capacitors are so small they can be tucked in almost anywhere. Be sure to use a good-grade braided spaghetti on the leads, and make connections very secure. Clean up the motor commutator and be sure that the brushes themselves are long enough, and the springs are OK. A loose brush makes too many sparks as the commutator spins, and that's the main cause of the noise.

Switches, which can cause a loud POP when they close or open, can be quieted by hooking a .05- $\mu$ F capacitor across the contacts. This will quiet blower and fluorescent-light switches, thermostats and similar devices.

Run wires from the frames of all large appliances, such as washers, dryers and so on, to a good ground. A cold-water pipe is the best. (Never use a gas pipe! Gas-pipe joints are often insulated, and there may be no connection to ground through the pipe.) Water-pipe grounds (or outside "stake-in-the-ground" grounds) prevent serious shocks and some kinds of noise.

Fluorescent lights are frequent offenders. Clean up the contacts of the lamp-sockets, and, in bad cases, add a small filter like Fig. 4 to the fixture, right at the lamp. This can usually be hooked up to the wires and mounted inside the fixture itself. Cover it well with tape to prevent short-circuits. Grounding the fixture is important, and in critical cases, like a noisy lamp over a bench where you want to measure microvolts, grounded screen or hardware cloth over the whole fixture—lamps and all—helps.

#### Aligning transistor radios

Where's the best place to hook up an output indicator when aligning transistor radios?—L.D.H., Valley Stream, N.Y.

You can use the old-fashioned output meter (an ac voltmeter across the voice coil) with a signal generator, or measure the a/c voltage with a vtvm, or use a scope across one of the audio stages and tune for maximum pattern height.

One of my associates aligns these things by watching the current meter on his bench power supply! You can get a pretty accurate "tuneup" by feeding in a modulated signal and tuning for maximum power-supply current!

#### Replacement flyback for Emerson C-504A Color

I have an Emerson C-504 color set and the flyback is burned up. Can you tell me where to get one?—S. D., Jersey City, N. J.

You can get this flyback from RCA. Address RCA Parts and Accesso-

## Now, for men in electronics —“a whole new era of quick calculation”

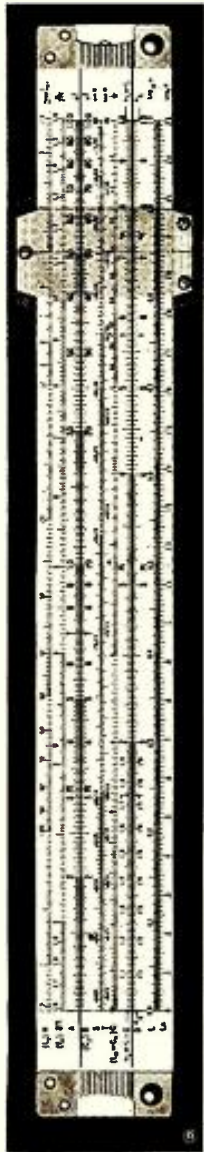

**T**HERE MUST BE THOUSANDS OF PEOPLE in electronics who have never had the marvelous adventure of calculating problems with a single slide rule; other thousands have had to content themselves with a slide rule not specifically designed for electronics. For both groups, the new slide rule designed and marketed by Cleveland Institute of Electronics and built for them by Pickett will open a whole new era of quick calculations.

“Even if you have never had a slide rule in your hands before, the four-lesson instruction course that is included takes you by the hand and leads you from simple calculations right through resonance and reactance problems with hardly a hitch. If you already use a slide rule, you'll find the lessons a first-rate refresher course. And it explains in detail the shortcuts built into this new rule.”

From an article in  
**Radio Electronics Magazine**

Want complete details about this time-saving new Electronics Slide Rule? Just mail coupon below...or write Cleveland Institute of Electronics, Dept. RE-124, 1776 East 17th St., Cleveland, Ohio 44114.

Mail this coupon for  
**FREE BOOKLET**



**CIE** Cleveland Institute of Electronics  
1776 E. 17th St., Cleveland, Ohio 44114

Please send me without charge or obligation your booklet describing the CIE Electronics Slide Rule and Instruction Course. Also FREE if I act at once: a handy pocket-size Electronics Data Guide.

Name \_\_\_\_\_ (please print)

Address \_\_\_\_\_

City \_\_\_\_\_ State \_\_\_\_\_ Zip \_\_\_\_\_

Accredited Member National Home Study Council  
A Leader in Electronics Training... Since 1934

RE-124

Circle 18 on reader's service card

# The Sound of Marantz is the Sound of Music at its Very Best.

**SLT-12 Turntable**, with Straight Line Tracking—a revolutionary development from Marantz. Finally, the art of tracking a record precisely duplicates the art of cutting a record. The Marantz SLT-12 Straight Line Tracking System exactly conforms to the angle, posture and the tracking used in the cutting of an original master stereo record. This perfect compatibility eliminates inherent deficiencies of conventional swing arm record player systems and gives incredibly perfect reproduction. It is the only system available which faithfully reproduces sound as it was originally recorded.

**10B FM Stereo Tuner**—rated by Hi Fi/Stereo Review magazine, "I have never seen a tuner to compare with it...so outstanding that it is literally in a class by itself."

**7T Solid State Stereo Console**—a solid state component unequalled in performance, versatility and flexibility.

**8B Dual 35 Stereophonic Power Amplifier**—American Record Guide magazine says, "The Marantz 8B is a logical choice for ears that demand the best sound for now and for the future."

## marantz

MARANTZ, INC. SUBSIDIARY OF **SUPERSCOPE** • INC.  
25-14 BROADWAY, LONG ISLAND CITY, NEW YORK

Model 7T Stereo Pre-Amplifier



Model 8B Stereo Amplifier



Model SLT-12 Turntable



Model 10B Stereo Tuner

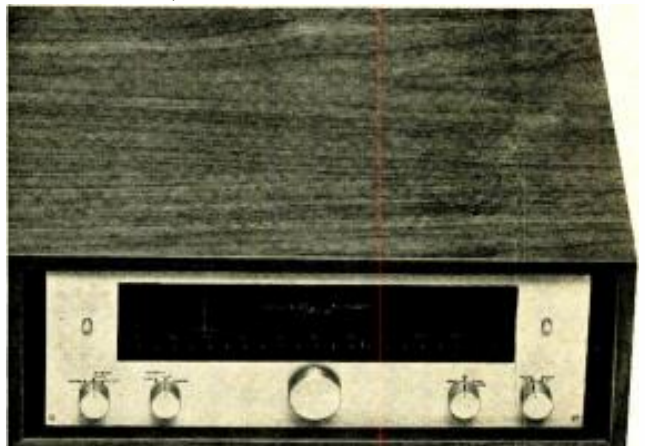

*A wonderful adventure in sound awaits you with your discovery that the sound of Marantz is the sound of music at its very best. You, too, can own an incomparable Marantz system. Ask your dealer about the easy finance plan.*

*Circle 24 on reader's service card*

# ATTENTION! CB OPERATORS

save on citizens radio equipment

## Discontinued Models From International Radio Exchange

Select that extra transceiver for mobile or base installation, or equip a new station. Our stock includes International types as well as other makes.

*Write Today for A  
Complete List of  
Equipment in Stock*



**RADIO EXCHANGE**  
18 NO. LEE, OKLA. CITY, OKLA. 73102  
Division Of International Crystal Mfg. Co.  
Dealing In Used Citizens  
Radio Equipment



Circle 11 on reader's service card

# can you give your electronics career more mo men tum?

PAGE 63 OFFERS YOU MORE INSIGHT INTO THE SUBJECT.

ries, 2000 Clements Bridge Road, Deptford, N. J. 08096. It'll cost you a pretty penny, but that's the only place I know of that you can get them. The original number on this one is 738123.

### Color generator patterns unstable

*I can't get the patterns on my bar-dot generator to stabilize. They all look like this (photo), or worse. What's the matter?—E. F., Coventry, Conn.*

I'd say that your rf carrier frequency is off. I tried to duplicate this on my own, and got almost exactly the same patterns!

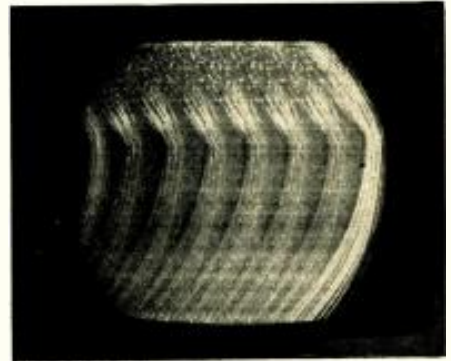

Try this: tune in a color show on a color set known to be working. Set the fine tuning just right to get correct hues, no beats, etc. Now, let the set alone; hook up your bar-dot to the antenna terminals, and carefully tune the rf adjustment (usually on the back) until your patterns lock in.

A crosshatch pattern is good for this. Tune for the sharpest vertical lines, without any trace of ringing. When you hit the right point, you'll see the pattern "sharpen up." Leave it there and hook up the antenna again, to recheck. It's not a bad idea to make this test every so often, just to be certain that your bar-dot is still right on the nose. In a few cases, I've seen them drift. Warm the instrument up for at least 15 minutes before using it.

### Constant voltage or Constant impedance?

*We've got two separate PA speaker systems, and we'd like to hook them up to one amplifier. One is a constant-voltage system rated at 20 watts, and the other a constant-impedance system with 200 ohms total. Is there any way to combine these two? Can't get at the speakers to make changes without a lot of trouble.—L. G., Chicago, Ill.*

There isn't a lot of difference between constant-voltage and constant-impedance systems, except in the way you look at them, and make computations, etc. Check the excellent article in the February 1965 RADIO-ELECTRONICS by G. A. Briggs.

RADIO-ELECTRONICS

The main difference is that the constant-impedance system uses primary taps and the constant-voltage system uses secondary taps. Many spec-sheets will tell you that "if constant-voltage transformers are not available, constant-impedance-rated transformers may be used." Actually, you can work out the line impedances on your two systems, and they'll come out somewhere around 220 ohms each.

So, it looks to me as if it would be possible to use a single amplifier, with enough power to drive all the speakers to the level you want, and hook them up to the 125-ohm tap on the output. There probably won't be enough of a mismatch to tell. Just hook both systems in parallel. You can hook 'em in series across 500 ohms if speaker wiring meets local electrical codes.

### Calibrating signal generators

*I've got two kit signal generators, one a sweep generator. How can I connect one to calibrate the other? Also, I've got 4.5- and 10.7-MHz crystals with one. How do I get these signals out and what do I do with them?—J. P., Union, N.J.*

To calibrate any signal generator, you need two things: a receiver that will pick up the signal, and a *standard* (accurate) signal. Here, the most convenient receivers are a TV set and an FM radio. For calibration standards, use broadcast stations. They are required to keep their carrier frequencies within very small tolerances.

Tune in a station (TV or FM), and then feed in the generator signal at the same time through a couple of small isolating resistors, or just make a loose coupling by clipping the generator lead to the antenna lead, right onto the insulation. Now tune the generator to the same frequency and look for a zero beat. If you're trying to find the picture carrier of a TV station, for instance, look for beats in the picture. You'll see these as wiggly patterns on the screen.

For instance, the video carrier of channel 5 is 77.25 MHz. Tune the generator near that frequency, then look for the beats. Tune until you find a point where the beat patterns get biggest (the fewest "waves"), and go up in frequency (more "waves") on either side. This is the zero-beat point.

To find the sound carrier, hook up a meter to the sound detector output, after the set has been properly tuned to a TV station carrier. Take off the antenna, hook up the generator and then tune for a zero reading at the detector output, with the voltage going positive on one side and negative on the other. When you find this, your signal generator will be exactly on the sound-carrier frequency—81.75 MHz on channel 5, for example. You can do this in the

same way for an FM radio signal.

After you've found the zero-beat points, note the dial reading of the signal generator. If it is off, you can correct it by readjusting the generator's calibration trimmers, or just make a note of the error at that point, for use the next time you want to set up that frequency.

To use the crystals, check the instruction book for your generator. The 4.5-MHz signal is for setting TV sound i.f. and sound detectors, the 10.7-MHz crystal for FM radio i.f. and detectors. You can use a modulated or unmodu-

lated signal with them. In most generators, crystal-controlled signals are brought out through the regular output cable, with the variable-frequency oscillator switched off or tuned to a far-different frequency.

### Rf overload, crosstalk, transistor auto radio

*I installed a transistor radio in a Plymouth. The owner complains that he gets severe crosstalk interference on a station on 1330 kHz from another sta-*



## Perk it up with Perma-Power COLOR-BRITE

Perma-Power does for color TV sets what we've done for millions of black and white CRT's: adds an extra year of useful picture tube life.

When a color tube begins to fade, COLOR-BRITE *instantly* brings back the lost sharpness and detail. It provides increased filament voltage to boost the electron emission and return full contrast and color quality to the 3 gun color picture tube.

COLOR-BRITE is automatic . . . no switching or wiring. Just plug it in. Your delighted customers will brighten up as fast as their color sets!

Model C-501, for round color tubes.

List Price \$9.75

Model C-511, for rectangular color tubes.

List Price \$9.75



COLOR-BRITE is a Hue-Brite product from Perma-Power, famous in TV service for b & w Vu-Brites and Tu-Brites.

**Perma-Power** COMPANY

5740 N. TRIPP AVE., CHICAGO, ILLINOIS 60646

PHONE (312) 539-7171

Circle 20 on reader's service card

finger-  
tip avail-  
ability



## AEROVOX HAS 1212 EXACT REPLACEMENT TWIST PRONG AFH ELECTROLYTICS

Why fool with "jerry-rigged" electrolytics when there's an Aerovox exact replacement to give you the right rating and the right size? Aerovox actually stocks 1212 twist prong AFH electrolytics—this means off-the-shelf availability... not "we'll build it for you if you order it" delivery.

Available in singles, doubles, triples and quads, these popular types are now manufactured in new values for filter bypass applications in color TV as well as radio, black and white TV and amplifier equipment. Many values are now being used for industrial applications.

Aerovox AFH Twist Prong Electrolytics feature ruggedized prongs and mounting terminals, high purity aluminum foil construction, improved moisture resistant seal and 85°C operation. Here is the quality you need to protect your professional reputation.

Go to your Aerovox Distributor for a perfect electrolytic fit—he will deliver exactly what you want in less time than it takes to tell. Ask him for the new Aerovox Servicemen's Catalog #SE-565 or ask us. We'll be happy to send one your way.



**AEROVOX  
CORPORATION**

DISTRIBUTOR DIVISION, NEW BEDFORD, MASS.

Technical Leadership—Manufacturing Excellence

Circle 21 on reader's service card

tion on 1360 kHz. I don't know exactly what to do about this. An antenna trap, maybe?—N.D., Danvers, Mass.

Probably the best answer in the long run. Early transistor car radios and others had some trouble from rf overloading in the presence of strong off-channel signals. The only answer I can see here is to reduce the amplitude of the offending signal as much as possible, and this means a trap in the antenna.

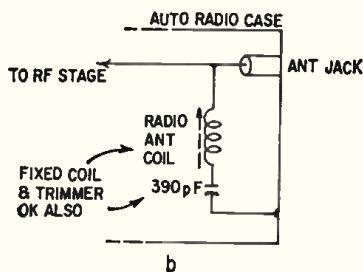
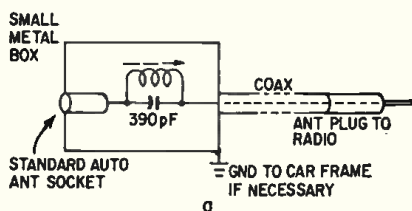

Try this: build a parallel-tuned trap in a little tin box, with an antenna socket on it. Put a short piece of coax with an antenna plug into the other side, as in drawing *a*. Leave a tiny hole in the side of the box so the trap can be tuned. Set it for minimum signal with the set tuned to the offending station, 1360 kHz.

If this doesn't get rid of all the interference, hook up a series-tuned trap inside the radio set, from the antenna input to chassis, as shown in *b*.

Parallel-tuned traps offer a *high* impedance to the signal to which they're tuned: series-resonant traps have a very *low* impedance at their resonant frequency. So, we use parallel-tuned ones in series, and series-tuned ones in shunt, as shown.

Use antenna coils from transistor radios as traps. Commercial tuned traps are available in this frequency range, also. END

### CAR TALK

Auto buffs: take special note of SIMPLE DWELL-TACH METER feature in August RADIO-ELECTRONICS. What it is, how it works, what it can do for you, all outlined in crisp, clear, streamlined RADIO-ELECTRONICS style.

**AUGUST TEST INSTRUMENT  
SPECIAL ISSUE  
RADIO-ELECTRONICS**

**Buy the BEST!  
Buy in KIT form!**



**MARK® TEN**

**SCR** CAPACITIVE DISCHARGE  
IGNITION SYSTEM

ONLY \$29.95 PPD.!

Why settle for less in motor vehicle ignition systems when you can buy the very BEST from Delta, the originators, the leaders in capacitive discharge (SCR) systems. Delta pioneered this electronic marvel. Thousands have installed this remarkable electronic system. Now YOU can purchase at low, LOW cost, and in easy-to-build kit form, the king of them all, the DELTAKIT. Low price due simply to high production levels at no sacrifice in peerless Delta quality.

**Operate Any Motor  
Vehicle More Efficiently**

Compare these proven benefits:

- ▲ Up to 20% Increase in Gasoline Mileage
- ▲ Installs in Only 10 Minutes on any Car or Boat
- ▲ Spark Plugs Last 3 to 10 Times Longer
- ▲ Instant Starts in all Weather
- ▲ Dramatic Increase in Acceleration and General Performance
- ▲ Promotes More Complete Combustion

Literature and complete technical information sent by return mail.

**BETTER YET—ORDER TODAY!**

**DELTA PRODUCTS, INC.**

P.O. Box 1147 RE, Grand Junction, Colo. 81501

Enclosed is \$\_\_\_\_\_. Ship prepaid.  
 Ship C.O.D.

Please send:  
 Mark Tens (Assembled) @ \$44.95  
 Mark Tens (Delta Kit) @ \$29.95

SPECIFY— Positive Ground  Negative Ground  
 6 or  12 Volt

Car Year \_\_\_\_\_ Make \_\_\_\_\_  
Name \_\_\_\_\_  
Address \_\_\_\_\_  
City/State \_\_\_\_\_ Zip \_\_\_\_\_

DP 6-2

Circle 22 on reader's service card  
RADIO-ELECTRONICS



# Editors Report on Heathkit® Stereo Receivers!

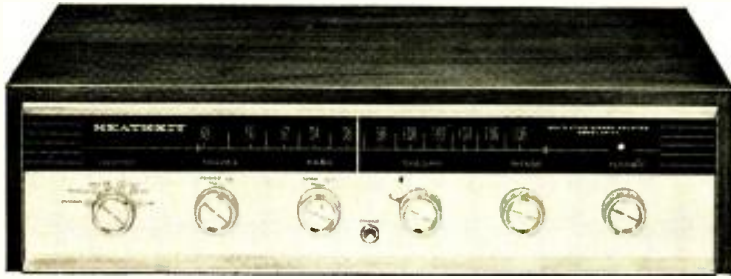

**AUDIO** March '66 Issue

*"At a kit price of \$99.95, the AR-14 represents an exceptional value" . . . "And the low price has not been reached by any apparent sacrifice in quality."*

## AR-14 30-Watt Solid-State FM /FM Stereo Receiver . . . . . \$99.95\*

**AUDIO** Also Said: "Although it is seldom the policy of this department to use superlatives in describing any individual piece of equipment, this is one time when it is possible to say that the unit in question is undoubtedly one of the best values we have encountered to date."

*"Heath's claims for the AR-14 are relatively modest — 5 uv sensitivity, 10-watt continuous power outputs (15-watt music power), channel separation of 45 db or better and so on. We found that the continuous power output at 1 per cent distortion measured 12.5 watts per channel (both channels operating), sensitivity nearer 3.5 uv, and channel separation 47 db. Frequency response at 1 watt measured 10 to 65,000 Hz ±1 db, and 5 to 112,000 Hz ±3 db. At 10 watts output, the two figures changed to 15 to 55,000 Hz and 8 to 92,000 Hz."*

*"So far we have not yet seen a comparable unit at anywhere near the price, even taking into account the nearly 20 hours required to*

*build it. That's part of the fun, though, and sometimes we build kits for the sheer relaxation that results. And this one was well worth it."*

### AT A GLANCE

- 31 transistor, 10 diode circuit for cool, hum-free operation and smooth, instant transistor sound • 20 watts RMS, 30 watts IHF music power at ±1 db from 15 to 50,000 cps • Wideband FM stereo tuner, plus two power amplifiers and two preamplifiers • Front panel headphone jack • Bookshelf size . . . only 3 7/8" H x 15 1/4" W x 12" D • Install in a wall, your own cabinet or either optional Heath assembled cabinets • Builds in 20 hours.

Kit AR-14, 17 lbs. . . . less cabinet for custom mounting . . . . . \$99.95  
 Model AE-55, 6 lbs. . . . walnut veneer cabinet . . . . . \$9.95  
 Model AE-65, 6 lbs. . . . beige steel cabinet . . . . . \$3.95  
 \*less cabinet

## HiFi/Stereo Review Nov. '65

*"It is one of the finest integrated stereo receivers I have seen, comparable to many factory-wired tuners costing far more."*



## AR-13A 66-Watt Solid-State AM /FM /FM Stereo Receiver . . . . \$184.00!

**Hi-Fi/Stereo Review** Also Said: "It delivered substantially more than its rated 20 watts over the entire audio range. Unlike many transistor amplifiers the AR-13A has low 1M distortion at low power levels: under one per cent up to 4 watts, and rising gradually to about 2.5 per cent at 20 watts per channel output. Hum and noise were inaudible: —55 db on the magnetic-phono inputs and —70 db on the high-level inputs, referred to 10 watts output."

*"The FM tuner proved to be quite sensitive . . . Drift is negligible, and AFC is hardly needed, although it is provided. The FM stereo channel separation was excellent, exceeding 22 db from 30 to 10,000 cps, and 35 db from 250 to 2,000 cps. None of the wiring or mechanical*

*assembly was difficult, and the set worked well from the moment it was turned on."*

### AT A GLANCE

- 46 transistor, 17 diode circuit • Compact, yet houses two 33-watt power amplifiers . . . two preamplifiers . . . and wideband AM/FM/FM stereo tuner • Delivers 40 watts RMS, 66 watts IHF music power at ±1 db from 15 to 30,000 cps • Built-in stereo demodulator . . . automatically switches to stereo • Stereo indicator • Filtered outputs for "beat-free" recording • Luxurious preassembled walnut cabinet included.

Kit AR-13A, 35 lbs. . . . . \$184.00

**Get Full Details & Specifications In FREE Catalog!**



**FREE!**  
**World's Largest Kit Catalog!**  
 108 pages! Over 250 easy-to-build kits for stereo/hi-fi, amateur radio, shortwave, test, marine, CB, educational.  
 Mail coupon or write  
 Heath Company, Benton Harbor, Michigan 49022.



Heath Company, Dept. 20-7  
 Benton Harbor, Michigan 49022

Enclosed is \$ \_\_\_\_\_, plus shipping.

Please send model (s) \_\_\_\_\_

Please send FREE Heathkit Catalog.

Name \_\_\_\_\_

Address \_\_\_\_\_

City \_\_\_\_\_ State \_\_\_\_\_ Zip \_\_\_\_\_

Prices & specifications subject to change without notice.

HF-192

In today's electronics boom, the demand for men with technical education is far greater than the supply of graduate engineers. Thousands of real engineering jobs are being filled by men without engineering degrees—provided they are thoroughly trained in basic electronic theory and modern application. The pay is good, the future is bright...and the training can now be acquired at home—on your own time.

# How to become a “Non-Degree Engineer”



**T**HE ELECTRONICS BOOM has created a new breed of professional man—the non-degree engineer. Depending on the branch of electronics he's in, he may "ride herd" over a flock of computers, run a powerful TV transmitter, supervise a service or maintenance department, or work side by side with distinguished scientists on a new discovery.

But you do need to know more than soldering connections, testing circuits and replacing components. You need to really know the fundamentals of electronics.

How can you pick up this necessary knowledge? Many of today's non-degree engineers learned their electronics at home. In fact, some authorities feel that a home study course is the *best way*. *Popular Electronics* said:

"By its very nature, home study develops your ability to analyze and extract information as well as to strengthen your sense of responsibility and initiative."

#### Cleveland Method Makes It Easy

If you do decide to advance your career through home study, it's best to pick a school that *specializes* in the home study method. Electronics is complicated enough without trying to learn it from texts and lessons that were designed for the classroom instead of the home.

Cleveland Institute of Electronics concentrates on home study exclusively. Over the last 30 years it has developed tech-

niques that make learning at home easy, even if you once had trouble studying. Your instructor gives the lessons and questions you send in his undivided personal attention—it's like being the only student in his "class." He not only grades your work, he analyzes it. And he mails back his corrections and comments the same day he gets your lessons, so you read his notations while everything is still fresh in your mind.

Students who have taken other courses often comment on how much more they learn from CIE. Says Mark E. Newland of Santa Maria, Calif.:

"Of 11 different correspondence courses I've taken, CIE's was the best prepared, most interesting, and easiest to understand. I passed my 1st Class FCC exam after completing my course, and have increased my earnings by \$120 a month."

#### Always Up-to-Date

Because of rapid developments in electronics, CIE courses are constantly being revised. This year's courses include up-to-the-minute lessons in Microminiaturization, Laser Theory and Application, Suppressed Carrier Modulation, Single Sideband Techniques, Logical Troubleshooting, Boolean Algebra, Pulse Theory, Timebase Generators...and many more.

#### CIE Assures You an FCC License

The Cleveland method of training is so successful that better than 9 out of 10 CIE

men who take the FCC exam pass it—and on their first try. This is despite the fact that, among non-CIE men, 2 out of every 3 who take the exam fail! That's why CIE can promise in writing to refund your tuition in full if you complete one of its FCC courses and fail to pass the licensing exam.

#### This Book Can Help You

Thousands who are advancing their electronics career started by reading our famous book, "How To Succeed in Electronics." It tells of many non-degree engineering jobs and other electronics careers open to men with the proper training. And it tells which courses of study best prepare you for the work you want.

If you would like to cash in on the electronics boom, let us send you this 40-page book free.

Just fill out and mail the attached card. Or, if the card is missing, write to:

### Cleveland Institute of Electronics

1776 E. 17th St. Dept. RE-21, Cleveland, Ohio 44114

Accredited Member National Home Study Council  
A Leader in Electronics Training... Since 1934

**NEWS FOR VETERANS:** New G.I. Bill may entitle you to Government-paid tuition for CIE courses if you had active duty in the Armed Forces after Jan. 31, 1955. Check box on reply card for details.



# World's Most Expensive FM Tuner

Marantz 10-B, Rolls-Royce of FM tuners, combines superb engineering and unusual circuit features

By PETER SUTHEIM

ON OUR COVER THIS MONTH ARE TWO views of the world's most expensive FM tuner: the Marantz 10-B. It costs \$750, and there are no discounts. At this writing, the Marantz Co. can see the

5,000th model 10-B not too far ahead. Knowing the company's reputation—which is unusually spotless in an industry as fast-moving and often cut-throat as hi-fi is—it seemed unlikely that the high price was a product of cynical steel

nerve. The 10-B just *had* to be a significantly better tuner than any other.

It costs twice as much as any other hi-fi/stereo FM tuner on the market!

My question—shared with several thousand other people: why?

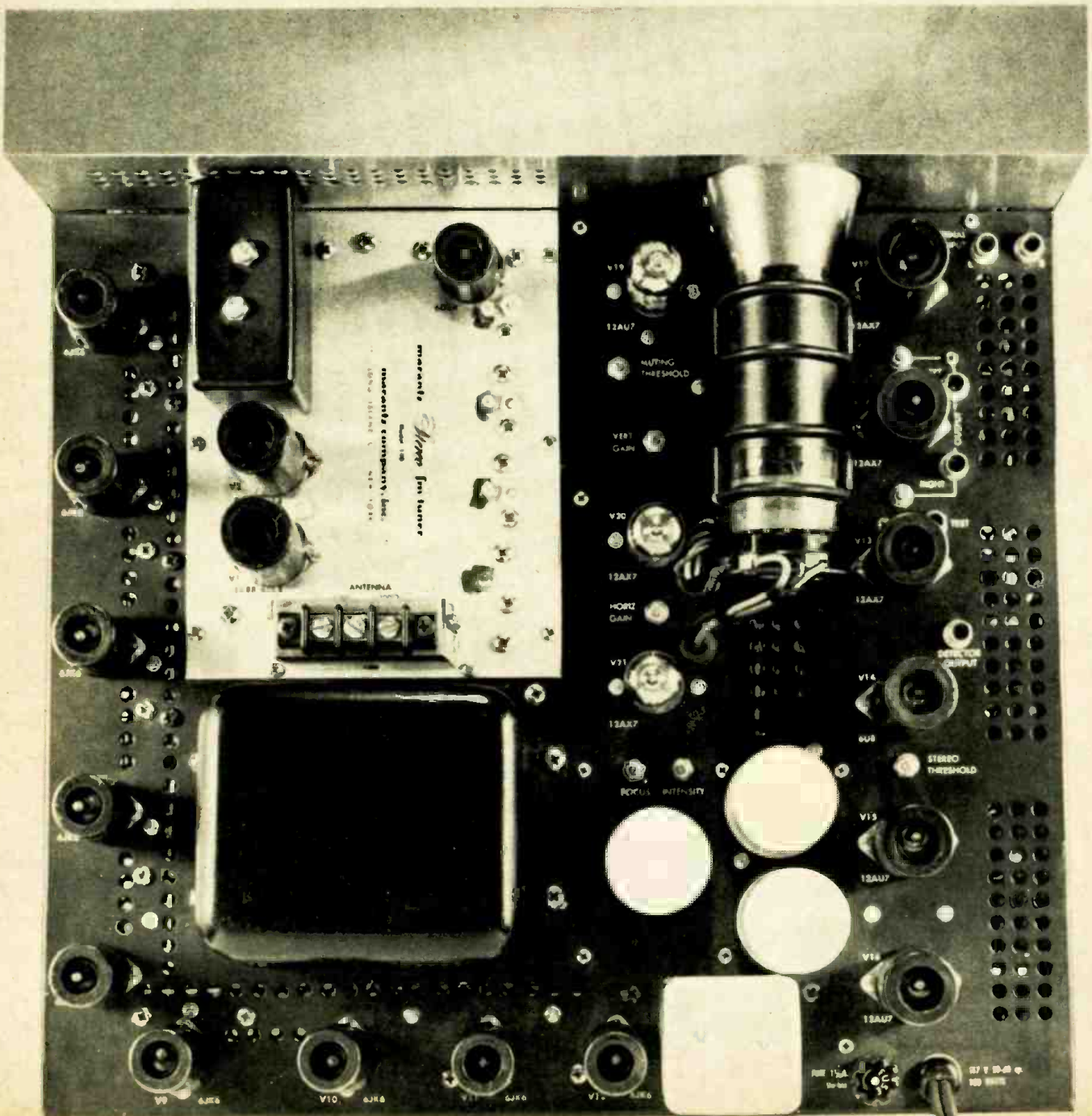

# Radio-Electronics

Hugo Gernsback, Editor-in-Chief



From its beginning, in January 1954, the Marantz Co. has always been associated with the better—and usually the more expensive—hi-fi equipment generally available. Until 1965, the output of the company was strictly and literally audio: just a preamp and some power amplifiers.

When the company decided at last to produce an FM tuner, it was determined at the outset that it would have to be better than anything else on the market, in keeping with the company's reputation.

The coming of multiplexed FM stereo in 1961 and 1962 brought a snarl of FM reception problems, plus accusations, claims, counterclaims and a good deal of ill will. Stereo FM quality was often atrocious. Audiophiles charged broadcast stations with incompetence, and the broadcast stations retorted with accusations of poor antenna

and receiver design, and unavoidable multipath reception.

Whoever was at fault, it was clear that somebody was doing something wrong. Stereo FM reception was a far more critical and delicate matter than anyone had guessed. One of the worst difficulties, as the broadcasters claimed, is multipath reception. Signals from the same station arrive at the receiving antenna by several paths, separated from each other by a few microseconds because of reflection from buildings, airplanes or a rippling ionosphere. Channel separation in FM stereo depends critically on the phase relationship among the amplitude-modulated sub-carrier sidebands (which carry the stereo information), the main carrier and the 19-kHz pilot signal. Anything that disrupts these relationships causes poor (or—worse—varying) channel separation. It may cause reversal of channels and a good deal of high-frequency distortion and flutter.

For the same reason, the *phase linearity* of the receiver is a vital consideration. Ideally, there must be no *nonlinear* phase shift in the signal being processed through the receiver as it swings from zero deviation (center frequency) to  $\pm 75$  kHz, defined by the FCC as 100% modulation. While any nonlinear phase shift might not be noticeable in monaural FM, it is in stereo, because of the need to keep the 19-kHz pilot and sidebands firmly phase-locked.

If the FM receiving circuits are not to alter the phase relationships of the signal, they must process the selected signal in a phase-linear way. At the same time, they must select one station and reject all others. It isn't hard to design a filter to do one of these jobs, but to make one that does both is tremendously difficult.

The conventional double-tuned i.f. transformer most commonly used in FM tuners can be linearized over a bandwidth of some 200 kHz, but its

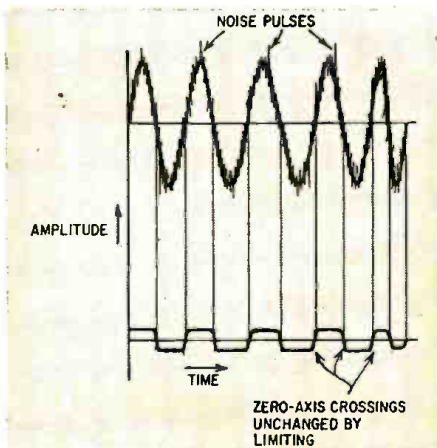

Fig. 1—FM information is recovered from zero-axis crossings so waveform may be clipped without detracting from fidelity.

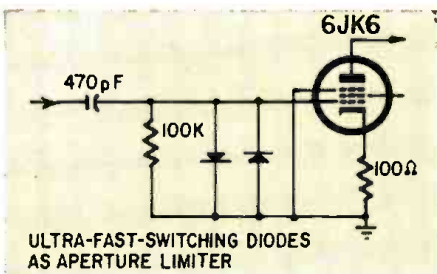
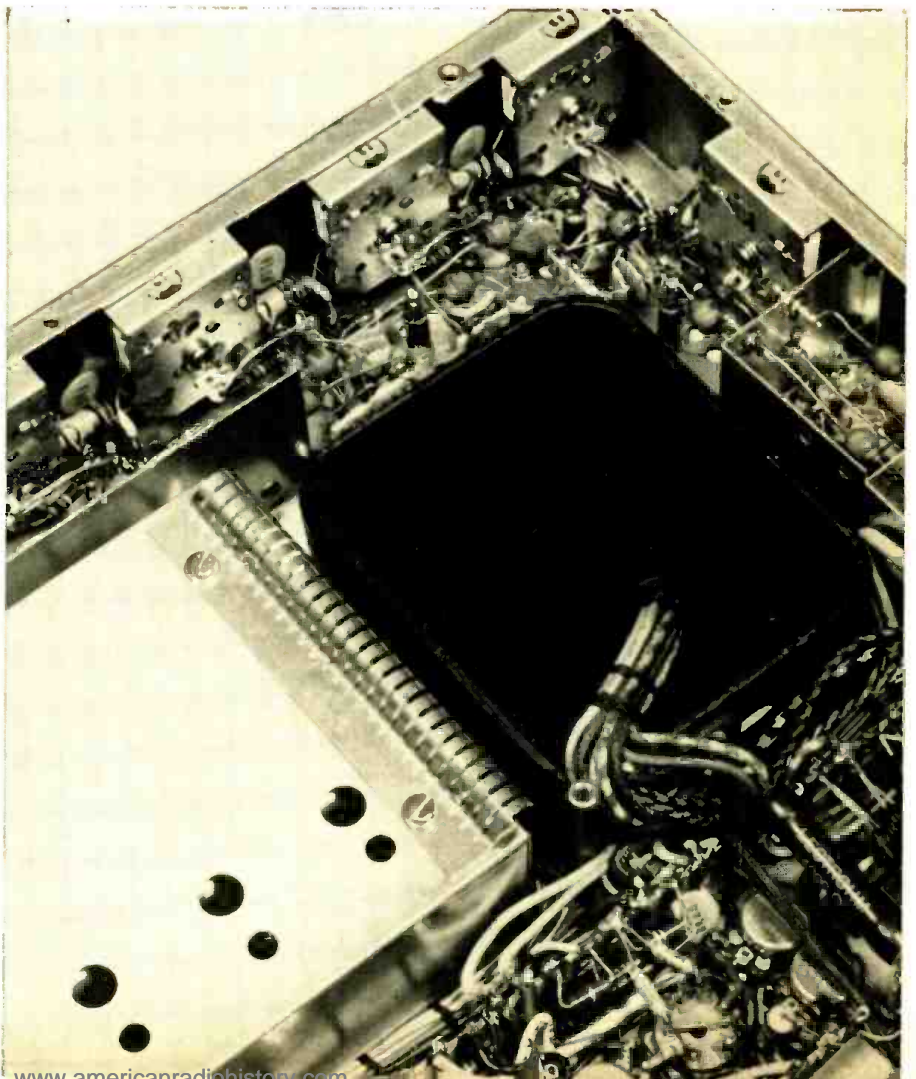

Fig. 2—Diode aperture limiter operates without bias and clips signal close to zero.

Notice i.f. filters around skirts of chassis. Holes at lower left are front-end alignment access.



selectivity is limited—a maximum skirt rejection of 12 dB per octave per stage. But a *three-pole Butterworth filter* can be made to satisfy three conditions: amplitude linearity, phase linearity, and a selectivity of 18 dB per octave per stage. That filter design is the one used in the Marantz 10-B. To illustrate the difference in selectivity alone, a conventional tuner with four i.f. stages coupled by double-tuned transformers

has a 48-dB/octave attenuation slope; the Marantz 10-B, with six stages coupled through the filters, has a 108-dB/octave slope. The difference is clearly apparent in the 10-B's ability to separate stations.

The result, as you can see in the schematic, is a system of six i.f. amplifier stages, cascaded, with a Butterworth filter at the input of each. The gain of the six cascaded stages is 72 dB, and

that of the limiter and detector drivers which follow the i.f.'s brings the total system gain to some 140 dB—a voltage gain of 10 million. The reason for that most uncommon amount of gain will be explained later. The filters, by the way, unlike conventional transformers, never need alignment once the factory is finished with them, even when an i.f. tube is changed.

But linear filters are not the whole

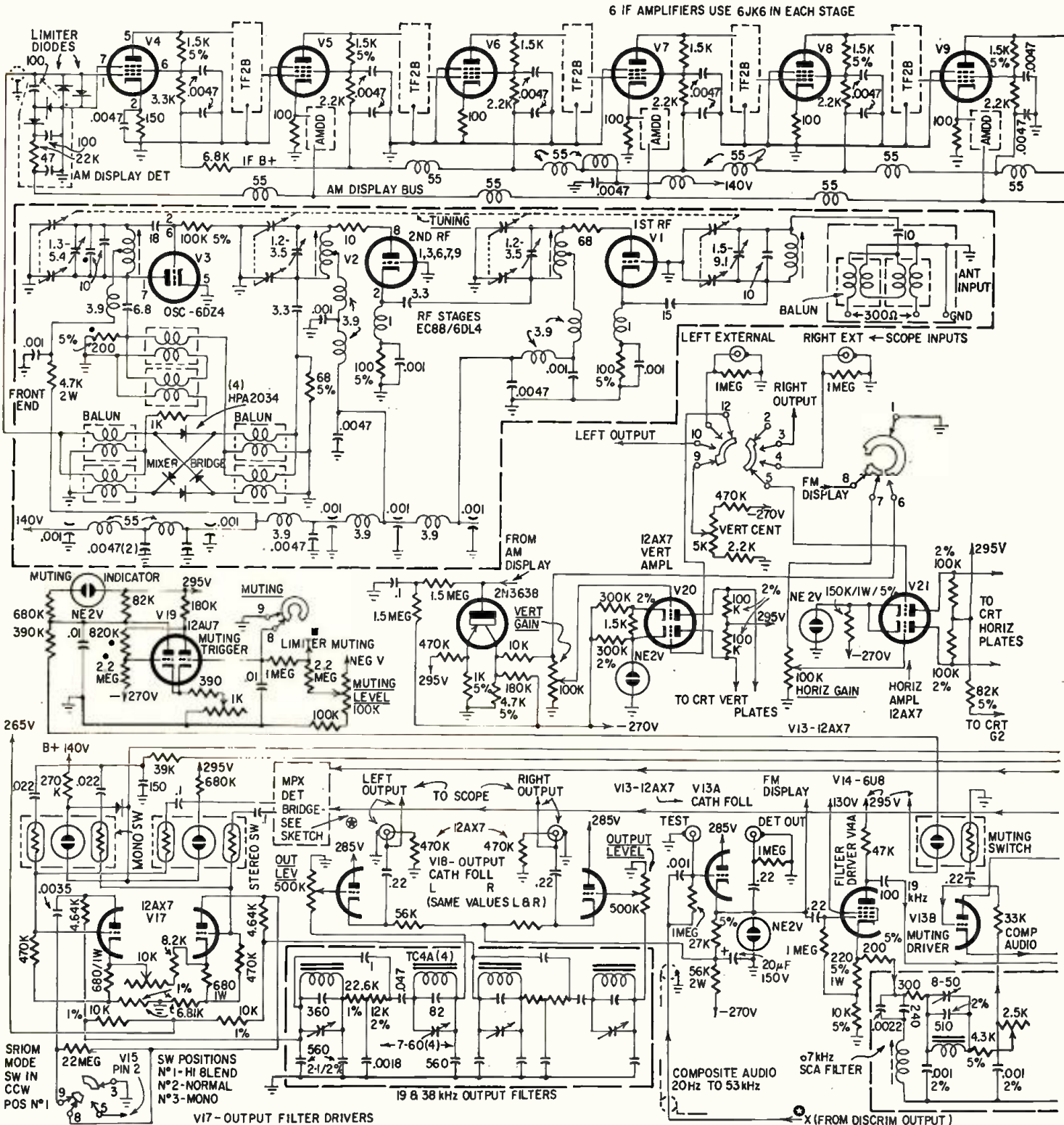



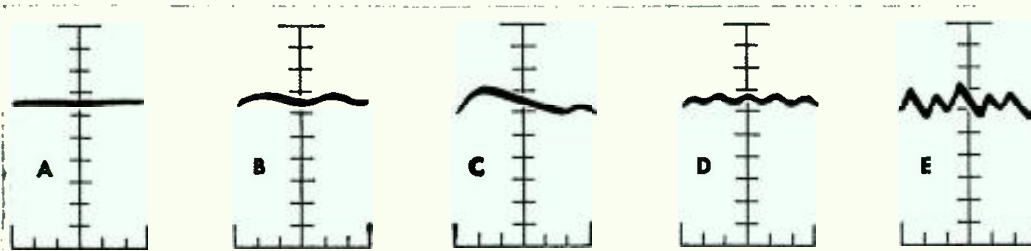

Fig. 3—CRT patterns show presence or absence of multipath interference. Pattern A is ideal. Patterns B through E show increasingly severe cases of multipath interference. The reception can be improved considerably with a sharp antenna with rotor for pin-point aiming.

separate limiters), it is not as linear or as perfectly balanced at high modulation frequencies as a phase discriminator can be.

Response to Marantz's most conspicuous innovation—a built-in cathode-ray oscilloscope tuning indicator—has been a mixture of skepticism and loud approval. If your idea of a tuning indicator pictures a device that helps you only to find the center of the FM channel or the point of strongest signal, a scope seems an extravagance. But the scope provides additional information that no other type of indicator can. Because it actually shows the dynamic passband of the tuner, it reveals problems like standing waves on the antenna lead-in, multipath reception, overmodulation at the station, and mistuning.

The oscilloscope is a simple affair—a compact 3-inch Amperex CRT driven by push-pull dc amplifiers for both vertical and horizontal plates. When the panel switch is set to TUNING, the vertical deflection is proportional to instantaneous carrier amplitude, and the horizontal deflection to the instantaneous frequency deviation (of the carrier from nominal station frequen-

Because the scope displays instantaneous carrier amplitude on the vertical axis, anything that affects the carrier amplitude will show up on the trace. Slow, long-term changes, such as might result from fading, simply shift the vertical position of the trace as a whole. Any amplitude change that depends on frequency—such as cancellation at some frequencies due to standing waves or multipath reflected signals—turns the trace from a straight line into a wavy one (Fig. 3b–3e). Because of that feature, any changes you make in the antenna system, from rotating your antenna to grasping the lead-in with your hand, show on the scope trace. Therefore, the scope is a valuable device for discovering multipath reception and eliminating it by adjusting the antenna. The difference in sound can be very noticeable. Persistent high-frequency distortion on some stereo programs disappears when the receiving antenna is properly oriented. And the only way to be sure the antenna is properly oriented, without listening for 15 minutes, is to watch the scope on the 10-B. Naturally, the scope is most useful with a directional antenna system on a rotor.

only the presence or absence of the 19-kHz pilot signal or the locally generated 38-kHz carrier. Both can exist without stereo program material; for example, a station may continue transmitting its pilot signal even while the program material is monaural. With the Marantz scope, there need be no confusion.

It's a pity there isn't room to detail some of the other features of the Marantz 10-B, like the multiplex demodulation circuitry which guarantees 30-dB separation at 15 kHz, or the complex and tremendously effective filters for removing any 67-kHz SCA subcarriers from multiplexed FM stereo signals and for killing virtually every trace of 19- and 38-kHz noise in the audio outputs. Another unique feature is the use of noiseless, quick-acting, maintenanceless light-dependent resistors for muting between stations and for stereo/mono switching.

Marantz says, "We'll probably never do anything quite like this again. It cost us around a quarter of a million dollars to develop the 10-B, and we were losing money on it at the original price of \$600."

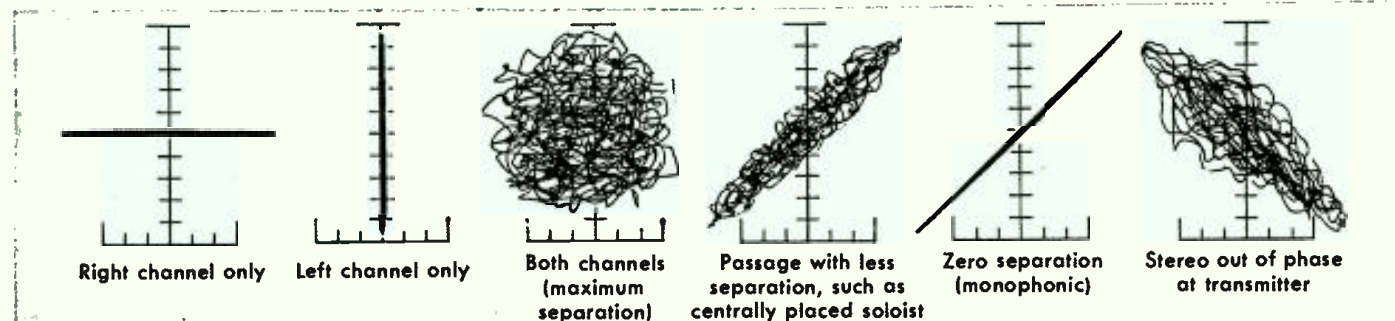

Fig. 4—The CRT also provides for program analysis, indicating strength of left- and right-channel signals, separation, phase.

cy). The pattern, with rapid, fairly high modulation and no reception problems, looks like a nearly straight horizontal line (Fig. 3-a). It is, except that it is really part of a flat-topped passband curve familiar to anyone who has ever sweep-aligned an FM or TV set. Because the passband of the 10-B is greater than the maximum deviation of any carrier (limited to  $\pm 75$  kHz), the scope beam should never crawl down onto the steep sides of the curve. If it does, the station is overmodulating.

Ever think you're hearing monaural sound even though your tuner's stereo indicator is lit? With the 10-B you don't have to wonder. You throw the scope's DISPLAY switch to LEFT/RIGHT OUTPUT and see. The display will be like one of the drawings in Fig. 4. And your question is answered. The oscilloscope now shows instantaneous left-channel amplitude (vertical) against instantaneous right-channel amplitude (horizontal). Stereo indicators (including the one on the Marantz tuner) show

The Marantz 10-B is, like the Rolls Royce or the Leica, the product of an approach that to some might seem fanatical. From the basic choice of certain circuits over others that would do the job *almost* as well, to the inclusion of an extra resistor here, and an extra stage there, the Marantz 10-B was designed to do everything it does better and longer, with less maintenance, than any other tuner. All this, of course, comes at a price, and only you can decide whether it's worth the money. END



# The Military Electronic Specialist Gap

**If you have any kind of electronics training—or would like to get some—the Armed Forces will pay you a premium!**

ARE YOU AN ELECTRONICS SERVICER? DO YOU know anything about radar? Are you able to learn missile control systems?

If you are, Uncle Sam needs you. He needs you badly enough to pay you well and hand you a bonus for staying with him. He needs you as an electronics specialist in the Army, in the Navy, Air Force and Marine Corps.

The expression used to be: "Join the Army and learn a trade." Now it's: "Know a trade? The Army needs you!"

That trade is electronics, the most critically short skill in the armed services. In the past year, the Army has grown by more than 180,000 men to a force of over 1,145,000 men. The electronic technicians, radarmen, radio repair men, and missile systems specialists have not grown apace.

The situation is even worse in the Navy, where a much larger percentage of the personnel must be electronics specialists due to the nature of a modern navy. The Navy needs 44,000 electronics repair petty officers and has only 19,900. There also are less than half the petty officers needed for communications and intelligence (operation of electronic intelligence gathering and processing equipment). The Navy has 15,000 and needs 38,000.

## CIVILIAN JOBS TO BE HAD, TOO

The Air Force has 27,000 civilian vacancies. Most urgently needed are 3,000 qualified technicians in grades GS-9, -11, and -12. Pay ranges from \$7,749 to \$10,619. These are newly authorized Civil Service positions resulting from the conversion of military jobs to civilian jobs and from the Southeast Asia buildup.

Officers at Air Force bases will do the recruiting for positions in the U.S. Readers interested in overseas employment should complete a Form 57 Application for Federal Employment, which is available from any first- or second-class post office or Federal personnel office. Each applicant should list the specialized electronic or engineering training he has received and the kinds of equipment he has worked on. The application should be sent to the nearest Air Force Overseas Employment Office or to the main office at Dept. of the Air Force, Washington 25, D.C.



This AN/GRC-106 single-sideband communications system is complex and requires trained operators and repair men. Specialists receive tops in pay.

Here is the way the Navy's critical shortage looks when broken down into a few specific electronics jobs:

The Navy has only 8,650 of the 9,604 petty officer radarmen it needs. There are but 7,650 of the required 10,190 communications technicians. The Navy can meet only 80% of its critical demand for 5,850 sonar technician petty officers.

The Air Force needs electronic skills as badly as the Army and Navy. Right now, however, the Air Force cannot say precisely how many technicians of various types it needs because it recently changed its technician training policies and has yet to see how well things are working out. If the new plan fails, Chief of Staff Gen. John P. McConnell says, the Air Force will be in the same *desperate* condition as the Navy; if it succeeds, the Air Force will merely be in *bad* shape.

Beyond the armed forces' needs for electronic skills, the Government and its contractors urgently need *civilian* electronics specialists for duty in Viet Nam and other overseas posts. Operating at the Defense Department level, above any of the military services, is the Advanced Research Projects Agency (ARPA) which has, among many other unrelated assignments, the responsibility for coming up with military answers to counterinsurgency, guerrilla warfare and low-level "limited warfare." Although generally hush-hush in its operations, ARPA estimates that well over half of its interests in Southeast Asia are electronic. Many are pursued by military specialists on duty with ARPA, some by Government civilians and many others by civilian contractors. The job of all is to study insurgency, watch the fighting and then come

up with solutions—often electronic—to help the white hats defeat the black hats.

ARPA specialists evaluate front-line radar, night-vision devices, communications equipment and intelligence devices. They have helped adapt burglar alarms to counter guerrilla activities and have conceived balloon-antenna systems for getting radio communications out of remote stations in dense jungle.

The Defense Department and the military services have civilian operations research firms—“thinking factories”—working for them in Viet Nam and elsewhere in Southeast



Navy's Tactical Data System displays aerial, sea-surface and submarine targets. Developed by Hughes, it is kept up by Navy.

Asia and in Africa. These firms, such as Research Analysis Corp., RAND Corp., Operations Research Inc., and the Center for Naval Analysis, send electronics-oriented “opsearchers” by the scores to Asia and Africa to examine, define and try to solve problems in communications, intelligence data-processing and equipment maintenance.

The Agency for International Development (AID) has a handful of communications and electronics specialists working in Viet Nam hamlets and in Saigon to develop low-cost, simple and foolproof radio communications equipment that can be distributed in great numbers to relatively untrained villagers. Recently, one AID expert received a commendation and a \$5,000 bonus for developing such a radio to enable even a totally uneducated village chief to call the national police at the first sign of a Viet Cong attack.

The war in Viet Nam has without question greatly increased and added urgency to the Government's needs for trained electronics specialists. The Government—especially the armed forces—has the figures to prove it.

The draft has picked up momentum, officials point out, and it is not expected to slow down in the foreseeable future. But the needed skills are not being drafted in any greater numbers than are other types such as farming, banking or store clerking. As the military ranks swell, harried generals and admirals have told Congress, the ranks of specialists must grow even faster to support the expanding services.

Yet, the armed forces are seeing their electronics specialists leave faster than new ones come. Aircraft radio repairmen with 31 weeks of specialized training, electronic data-processing technicians with 44 weeks of intensive EDP training and sonar technicians with 32 weeks of training have been

fleeing from the services at the earliest legal opportunity, usually after their first tour of duty is up.

Even old-school military personnel officials have acknowledged the reasons and admitted that the technicians have probably been justified. Now the services are doing something about it.

Thanks to some help from Congress, electronics careers in the armed forces are about to become nearly as attractive as the electronics careers in industry that have been spirited the specialists away.

Optimistic officials believe that the new shake for specialists might even lead men with electronics skills into joining. At the least, a new attitude toward pay for special skills and several bonus benefits are expected to make the fellow who learned his electronics in a military branch think twice about leaving.

No longer does the sharp young electronics whiz have to watch as the untrained incompetent draws more money on payday simply because he has put in more time. The proficiency pay structure—in itself something fairly new in military life—has been changed considerably.

Defense Secretary Robert S. McNamara explains it this way:

“To protect our heavy investment in the training of men for electronics and other hard skills, we must reduce to a minimum the loss of these specialists to the civilian economy. To this end, we changed the proficiency pay structure and are instituting a program of *variable* re-enlistment bonuses. The higher-proficiency pay scales are paid, for example, to guided missile electronics repairmen, radar technicians, and nuclear submarine powerplant operators.”

The radar technician provides a good case study of how the special pay for special skills concept works. A Marine Corps sergeant (grade E-5) without any critically needed technical skill is paid a bonus of about \$1,600 to re-enlist for six years. A sergeant (E-5) *radar technician* would receive the same \$1,600 *plus* \$6,400 for his special skill!



This corporal is teletyping a message via a 400-watt FSK/SSB system that operates on any rtty channel from 2 to 30 MHz.

In addition, once the radar technician re-enlisted, his technical skill would add \$100 per month to his pay check. Even at the lowest rank, there is an extra \$50 per month in the pay envelope of the electronics specialist.

The variable re-enlistment bonus has been paid in some form for two years. It applies to the *first* re-enlistment, and

will be paid to about 61,000 specialists who are expected to re-enlist in the coming year.

The effects of the bonus on keeping good men are now under study. Early returns indicate that it has helped. Also under study are ways besides pay boosts and bonuses to make military careers more attractive to electronics and other specialists by keeping the men happy.

Authorities see no end to the draft. The armed services will be depending on draftees for the next few years, at least. Because of this, the services are now seeking ways to get the maximum mileage from draftees who will get out at the first opportunity. The services also hope to find ways to encourage many of the more talented draftees to stay, take electronics training and remain as electronics careerists.

One such plan is now being tried in the Air Force and, with modifications, it will go into effect on a trial basis in all the services August 1. The Defense Department-wide program is a two-pronged one:

1. New men—those likely to leave at the end of a first hitch—will be given short functional training courses to enable them to operate necessary equipment. They will be able to make such simple repairs as pulling out and replacing "Module B" when a light flashes and commands "Replace Module B."

2. Career men—men with a minimum 6-year tour ahead of them—will be assured of getting broader training covering electronics fundamentals and practical training in troubleshooting and the use of test equipment.

Defense Department officials told RADIO-ELECTRONICS that they like the idea because it instructs short-timers in the care of equipment without wasting expensive instruction on men who will soon leave. The program will get short-timers on the job faster, while the services will be able to free their careerists to pursue longer and more comprehensive training without the need to yank them prematurely into the field for simple maintenance.

The Air Force program already under way consists of 750 men divided into three groups. One group receives the present full training in various electronics areas, some 30 to 45 weeks. It includes broad instruction in fundamentals and

practical work. A second group receives a course centered on equipment and containing virtually no fundamentals. The third group is receiving 18 weeks of training in electronics fundamentals and very little experience with equipment such as aircraft communications, radar, etc. One group recently finished its course and a second is nearly finished. Results will not be known, however, until sometime after the third group finishes in September. Then they will be intermingled on the job and their performance will be carefully watched and evaluated.

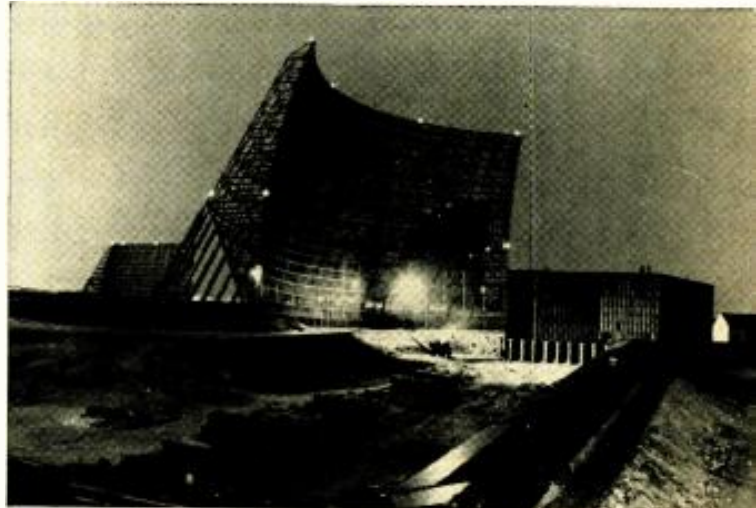

Can you repair this BMEWS radar? Someone has to! The War Department will pay a premium to the man who can do the job.

Most of the training is being conducted at Keesler Air Force Base, Miss., near Biloxi. It is the job of that center to train specialists to fill the 81,000 slots authorized in the Air Force for skilled technicians. Said a Keesler spokesman when queried by RADIO-ELECTRONICS: "We can train the men—if we can get them." END

## COMPUTERS GALORE

You just can't keep computers out of the news these days. They're everywhere. A recent survey by the American Federation of Information Processing Societies (AFIPS) tags computer investments at nearly \$8 billion, representing nearly 31,000 installations. Equipment costs average around a quarter-million dollars per installation. AFIPS expects that by 1970 there'll be more than 60,000 computer systems in use, valued at \$18 billion.

What are they used for? We've reported dozens of uses over the past months. Here are a few more:

One digital computer system will control a long-range tracking and instrumentation radar for anti-missile studies. Being developed by Sylvania, the ALTAIR (ARPA Long-range Tracking And Instrumentation Radar) system is part of the Defense Department's anti-ballistic-missile program which seeks to determine how a lethal warhead can be distinguished from other objects entering the earth's atmosphere.

The General Telephone Co. of Ohio will use an RCA Spectra 70 computer system to process 250,000 customer bills and 1,800,000 toll calls placed every month. The system will also keep track of labor, material and payroll records. Eventually, all this data will be placed in computer mass-storage files. The system, employing third-generation integrated circuitry, will include a card-reading device that can handle both printed and penciled notations.

Two independent English television companies use UNIVAC 1050 real-time computers for processing air-time inquiries and bookings as far as two years in advance. The system also prepares invoices, transmitting schedules, and order-acknowledgment notices.

Dozens of similar units are being used by the Air Force for inventory control at bases. And at Tinker AFB near Oklahoma City, a computerized system of scheduling, controlling, and reporting aircraft maintenance is being installed. The system, called DART (Daily Automated Rescheduling Technique), will spell out work schedules on B-52 bombers and C-135 transports and tankers, taking into account work time, numbers of workers required, and proper sequence of jobs.

West Germany's largest mail-order house—Grossversandhaus Quelle—is using two UNIVAC 494 data processing systems to link a worldwide network of ordering centers and department stores to its Fuerth, Nuremberg headquarters. The system also processes domestic mail-orders.

Two high-speed common-access computers are used in a central clearing house for airline reservations and other flight information. Companies that have agreed to use the RCA system (called AIRCON for Automated Information and Reservations Computer Operated Network) are Scandinavian Airlines System (SAS) and the Swiss Air Transport Co. Later, AIRCON will handle data on air-cargo-space reservations, flight planning, crew scheduling, and passenger and freight information.

# SHOW AND TELL

Homer photographs a group of problems and check them out, to show you what the trouble is and tell you where it lies By Homer Davidson

**A MAN BEHIND THE BARS?**

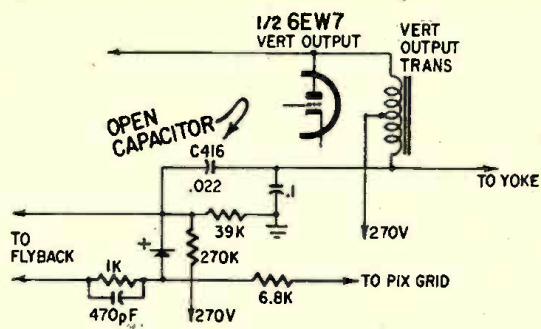

After the Admiral 21C5-14C chassis had warmed up a few minutes, the picture above was what we saw. There were bright white retrace lines, with a patch of white 2 inches wide on the right side of the screen.

The vertical hold control would not throw the picture out of sync, but small white retrace lines would move up and down the picture. The trouble was open capacitor C416, a .022- $\mu$ F job from the low end of the vertical output transformer to the retrace-blanking network. Use a well-rated replacement.

**BUT THE TUBE CHECKER IS OFTEN USEFUL!**

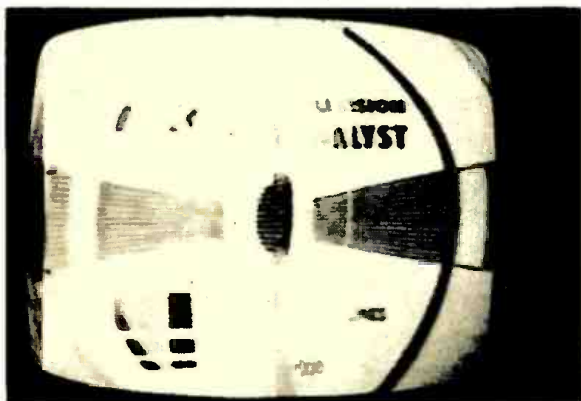

In this RCA KCS142F chassis, the picture had a horizontal foldover. Turning the horizontal hold control would squeeze the picture up and pull it in on the sides. The horizontal oscillator and output tubes were checked and found good. Voltage checks showed most of the voltages right on the nose. Both the horizontal tubes and the damper were replaced, and the picture came on in fine style. Each tube was pulled separately and it was found that the horizontal oscillator was at fault.

**THIS LOOKED LIKE VERTICAL TROUBLE**

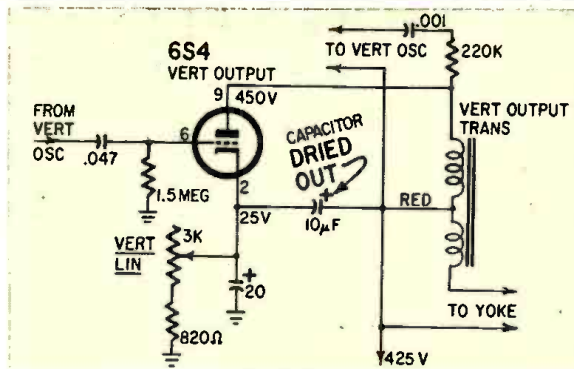

The test CRT showed a peaked test pattern with a foldover at the bottom of the screen. The picture on this Admiral 20Y4EF chassis was pulled up about three inches. This was definitely vertical trouble.

The vertical output tube was subbed and voltages checked. Resistance checks showed the vertical output transformer was good. The trouble was a dried-up electrolytic capacitor used as boost filter and connected between the red lead of the output transformer and the cathode bypass filter.

**HEAVIEST SNOWFALL OF THE WINTER**



In this picture, the bottom half is all white. The top of the picture is there, but cut off. There is a loud hum in the sound.

This trouble developed in an RCA KCS128 chassis. The customer just knew it was a bad filter. His neighbor fooled around a little with electronics and enlightened him on the subject. Could be. . . .

But the trouble turned out to be a shorted 6EA8 oscillator tube in the tuner.



THE SET HAD BEEN "FIXED" BEFORE

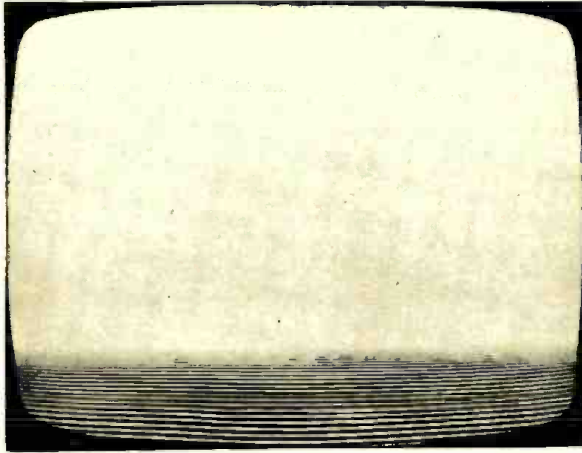

Here the problem is vertical. Only at the bottom were the raster lines pulled apart, over a band about

2 inches high. We "knew" the trouble was in the vertical circuit but we turned out to be wrong.

The vertical-circuit voltages and resistances checked quite close to published figures. This Admiral

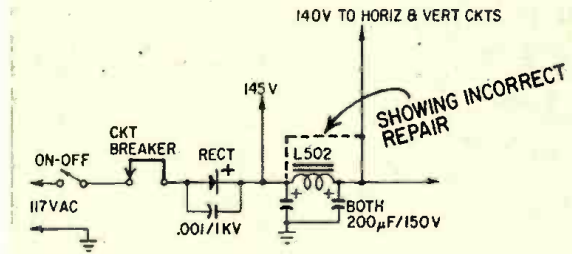

model UP-9808 had been worked on before (we saw the silicon diode and L502 had been replaced). Upon checking the wiring, we found that the B+ lead to the horizontal and vertical circuits had been rewired to the wrong side of the filter choke. END

## What VSWR Does to Your Communications

A voltage standing-wave ratio of up to 2:1 is not serious, but greater mismatching can rob you of expensive power

By DAVID L. PIPPEN\*

A TRANSMITTER IS NORMALLY DESIGNED to work into a particular load impedance. An antenna is designed to be driven by a transmitter with a particular output impedance. Likewise, the transmission line used to connect the transmitter to the antenna should have a characteristic impedance that will match the antenna and transmitter impedances. That, in a nutshell, is what this business of matching transmitter to line to antenna is all about.

If they are matched, the signal generated by the transmitter will be sent along the transmission line and applied to the antenna with maximum efficiency. The antenna can then radiate practically all the signal into space.

If there's a mismatch in the system, the energy traveling toward the antenna will be reflected and cancel the "fresh" energy from the transmitter at regular intervals along the line. Now, maximum and minimum voltage (and current) points exist on the transmission line; no longer can we open the line at any point and find the same rf current in it as at any other point. In radio parlance, the line is no longer "flat".

The ratio of maximum voltage to minimum voltage is a measure of system impedance matching and is called the *voltage standing wave ratio*, or VSWR. A VSWR reading of 2:1 (or just "2") implies that there is a system impedance mismatch ratio of 2 to 1.

VSWR meters for most frequencies are readily available and are an easy way to determine how well the parts of a par-

ticular system are matched. But, though the VSWR meter gives valuable information, it doesn't give much of a feel for just how badly a system's performance can fall off at various VSWRs.

So let's try a different approach.

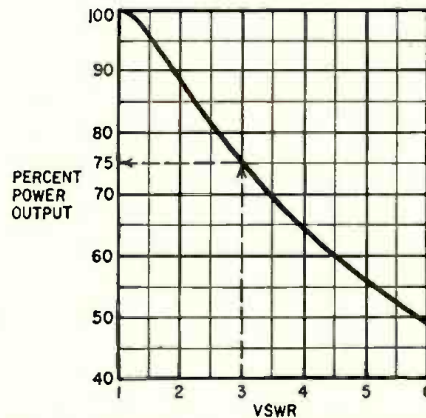

Fig. 1—Percent of power output versus voltage standing-wave ratio. 100% is the rf output of the transmitter into a perfectly matched, nonreactive load.

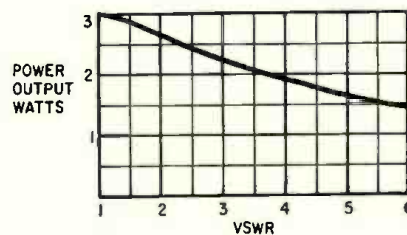

Fig. 2—Actual power output in watts of a 3-watt system with various VSWRs. This curve is handy for figuring the power output of CB transceivers.

Figs. 1 and 2 are graphs that can tell you at a glance how much power will be lost by a particular mismatch.

To use Fig. 1 for a particular system, measure the rf power output of the transmitter connected to a matched resistive load (many power meters use a resistive load), then measure the system VSWR with the transmission line and antenna connected. This information, with the graph of Fig. 1 and a simple calculation, will indicate power loss due to the VSWR.

As an example, suppose the measured rf power of a transmitter is 100 watts. The VSWR reading indicates 3 to 1. Find the VSWR of 3 on the horizontal axis of Fig. 1 and then move upward until you meet the curve. Then move to the left horizontally and read the percent power output (75% in this case). Now multiply the transmitter power by the percentage figure to obtain the reduced power output ( $100 \times 0.75 = 75$  watts); the 25-watt loss is caused by the VSWR.

So a VSWR of 3 causes a loss of 25% of the power a system could deliver with a VSWR of 1. A VSWR of 2 causes approximately 11% power loss, or about 0.5 dB. That's the generally accepted maximum VSWR for a system. The ideal system is, of course, 1:1.

For CB operators, there's Fig. 2. Most good CB radios can put out approximately 3 watts of rf for 5 watts of dc input. Therefore, by using Fig. 2, you CB'ers can calculate close to your actual effective power output for a particular VSWR. If you need a more accurate indication, calculate from Fig. 1, using the actual power output of the transmitter as previously explained. END

\* Manager, Electrical Measurements and Standards Laboratory, NASA-White Sands Test Facility, N. M.



# Stereo FM Stations: U.S. and Canada

In the 5 years since the FCC gave its official go-ahead to FM stereo, the number of stations broadcasting multiplexed stereo has grown from zero to the approximately 450 listed here. That rise almost equals the growth of AM broadcasting at its beginning 40 years ago. (There were 564 AM stations on the air by June, 1925.)

This tabulation contains all the FM stations known to be licensed

for broadcasting FM stereo in the USA and Canada, including educational stations. Some may send stereo for only a few hours a day. If you have a sensitive tuner with a high capture ratio, plus a highly directional antenna clear of obstructions and in a good spot for reception, you may be able to get more than one station clearly on a single frequency just by rotating your antenna to favor the one you want to hear.

<b>ALABAMA</b>				KMLA	100.3	<b>CONNECTICUT</b>		Pensacola	WPX-FM	94.1	
Birmingham	WCRT-FM	96.5		KPOL-FM	93.9	Brookfield	WGHF	St. Petersburg	WTCX	99.5	
	WSFM	93.7		KRHM	102.7	Hartford	WTIC-FM	96.5	WYAK	102.5	
Dothan	WOOF-FM	99.7	Los Banos	KARL-FM	95.9	Meriden	WBMI	95.7	WMCF	92.7	
Huntsville	WAHR	99.1	Monterey	KHFR	96.9	New Haven	WNHC-FM	99.1	WBGW	98.9	
	WNDA	95.1	Patterson	KHOM	93.1				WFSU-FM	91.5	
Mobile	WLPR-FM	96.1	Riverside	KDUO	97.5				WFLA-FM	93.3	
Montgomery	WAJM	103.3	Sacramento	KFBK-FM	92.5	<b>DELAWARE</b>		Tampa	WPBF	107.9	
	WFMI-FM	98.9		KHIQ	105.1	Wilmington	WDEL-FM	W. Palm Beach	WINT-FM	97.5	
Muscle Shoals	WLAY-FM	105.5	San Diego	KSFM	96.9		WJBR	99.5			
				KBBW	102.9	<b>DISTRICT OF COLUMBIA</b>					
<b>ALASKA</b>				KFMX	96.5						
Anchorage	KBYR-FM	102.1		KGB-FM	101.5		WASH	97.1	<b>GEORGIA</b>		
	KNIK-FM	105.5		KLRO	94.9		WGMS-FM	103.5	Albany	WGPC-FM	104.5
				KPRI	106.5		WMAL-FM	107.3	Americus	WDEC-FM	94.3
			San Fernando	KVFM	94.3				Athens	WGAU-FM	95.5
<b>ARIZONA</b>			San Francisco	KBRG	105.3	<b>FLORIDA</b>			Atlanta	WKLS	96.1
Phoenix	KMEO	96.9		KFOG-FM	104.5	Belle Glade	WSWN-FM	93.5	Carrollton	WLTA-FM	99.7
	KNIX	102.5		KMPX	106.9	Bradenton	WBRD-FM	103.3	Columbus	WSB-FM	98.5
	KOOL-FM	94.5		KPEN	101.3	Clearwater	WTAN-FM	95.7	Gainesville	WLBB-FM	92.1
	KRFM	95.5		KSFR	94.9	Cocoa	WEZY-FM	99.3	La Grange	WRBL-FM	102.9
Sun City	KTPM	106.3		KEEN-FM	100.3	Cocoa Beach	WRKT-FM	104.1	Moultrie	WDUN-FM	106.7
Tucson	KSOM	92.9	San Jose	KSJO-FM	92.3		WXBR	101.1	Rome	WLAG-FM	104.1
							WVCG-FM	105.1	Savannah	WMTM-FM	93.9
<b>ARKANSAS</b>			San Luis	KSBT-FM	93.3	Coral Gables				WROM-FM	97.7
El Dorado	KELD-FM	103.1	Obispo			Ft. Lauderdale	WFLM	105.9		WTOC-FM	94.1
	KRIL	99.3	Santa Barbara	KGUD-FM	99.9		WMJR-FM	100.7	<b>HAWAII</b>		
Fort Smith	KMAG	99.1		KMUZ	103.3		WINK-FM	96.9	Honolulu	KAIM-FM	95.5
Jonesboro	KBTM-FM	101.9	Santa Maria	KXFM	99.1	Ft. Walton Beach	WFTW-FM	99.3		KPOI-FM	97.5
Little Rock	KARK-FM	103.7	Stockton	KUOP	91.3	Gainesville	WRUF-FM	103.7	<b>ILLINOIS</b>		
			Ventura	KUDU-FM	95.1	Jacksonville	WIVY-FM	102.9	Bloomington	WJBC-FM	101.5
<b>CALIFORNIA</b>			Visalia	KONG-FM	92.9		WJAX-FM	95.1	Chicago	WJBC-FM	101.5
Alameda	KJAZ	92.7	Walnut Creek	KDFM	92.1		WKTZ-FM	96.1		WFMT	98.7
Bakersfield	KGEE-FM	101.5	Woodland	KATT	102.5		WQIK-FM	99.1		WKFM	103.5
	KIFM	96.5					WTOT-FM	100.9		WLS-FM	94.7
Fresno	KCIB	94.5	<b>COLORADO</b>			Marianna	WIOD-FM	97.3		WMAQ-FM	101.1
	KXQR	102.7	Colorado Springs	KLST	94.3	Miami	WWPB	101.5		WNUS-FM	107.5
Garden Grove	KGGK	94.3	Denver	KFML-FM	98.5	Beach	WAEZ	94.9		WXRT	93.1
Lodi	KCVR-FM	97.7		KLIR-FM	100.3	Milton	WXMB-FM	102.3	Crete	WTAS	102.3
Long Beach	KNOB	97.9		KTGM	105.1	Orlando	WHOO-FM	96.5	Decatur	WSOY-FM	102.9
Los Angeles	KCBH	98.7	Manitou Springs	KCMS-FM	102.7	Palm Beach	WWOS	97.9	Elmwood Park	WXFM	105.9
	KFAC-FM	92.3				Panama City	WMAI-FM	107.9			
	KFMU	97.1									
	KFOX-FM	100.3									

This chart is compiled, with permission, from material contained in the Howard W. Sams book "North American Radio-TV Station Guide" © 1966





<b>SOUTH DAKOTA</b>		Port Arthur	KFMP	93.3		WVAF	99.9	<b>MANITOBA</b>			
Sioux Falls	KELO-FM	92.5	San Angelo	KWLW	93.9	Martinsburg	WEPM-FM	97.5	Winnipeg	CBW-FM	98.3
			San Antonio	KEEZ	97.3					CJOB-FM	97.5
<b>TENNESSEE</b>				KITY	92.9	<b>WISCONSIN</b>				CKY-FM	92.1
Chattanooga	WDOD-FM	96.5	Sinton	KTOD-FM	101.3	Delafield	WHAD	90.7			
Kingsport	WKPT-FM	98.5	Wichita Falls	KNTO	95.1	Eau Claire	WIAL-FM	94.1	<b>NEW BRUNSWICK</b>		
McKenzie	WKTA	106.9				Green Bay	WBAY-FM	101.1	St. John	CFBC-FM	98.9
Morristown	WMTN-FM	95.9	<b>UTAH</b>			Kenosha	WAXO	96.9			
Nashville	WLAC-FM	105.9	Ogden	KBOC	101.9		WLIP-FM	95.1	<b>ONTARIO</b>		
	WNFO-FM	103.3	Salt Lake City	KSL-FM	100.3	Madison	WHA-FM	88.7	Cobourg	CHUC-FM	103.1
	WSIX-FM	97.9		KSOP-FM	104.3		WISM-FM	98.1	Hamilton	CHML-FM	95.3
Sevierville	WSEV-FM	102.1	<b>VIRGINIA</b>				WMFM	104.1	London	CFPL-FM	95.9
Tullahoma	WJIG-FM	93.3	Harrisonburg	WSVA-FM	100.7	Milwaukee	WRVB-FM	102.5	Ottawa	CFMO-FM	93.9
							WFMR	96.5	Sault Ste. Marie	CJIC-FM	100.5
<b>TEXAS</b>							WMKE	102.1		CKCY-FM	104.3
Abilene	KWKC-FM	105.1				Tomah	WTM-FM	94.5		CKSO-FM	92.7
Amarillo	KVII-FM	94.1	Martinsville	WMVA-FM	96.3	Wausau	WTMB-FM	98.9	Sudbury	CHFI-FM	98.1
Austin	KTBC-FM	93.7	Norfolk	WTAR-FM	95.7	West Bend	WSAU-FM	95.5	Toronto	CHUM-FM	104.5
Beaumont	KFHM	95.1		WYFI-FM	99.7		WBKV-FM	92.5		CJRT-FM	91.1
Clear Lake City	KMSC	102.1	Richmond	WFMV	103.7	<b>WYOMING</b>				CKFM-FM	99.9
Dallas	KIXL-FM	104.5	Roanoke	WLSL-FM	99.1	Cheyenne	KVVO-FM	106.3		CKLW-FM	93.9
	KVIL-FM	103.7	<b>WASHINGTON</b>						Windsor		
	WRR-FM	101.1	Aberdeen	KDUX-FM	104.7						
El Paso	KTSM-FM	99.9	Seattle	KBBX	98.9	<b>CANADA</b>			<b>QUEBEC</b>		
Fort Worth	KCUL-FM	93.9		KETO-FM	101.5	ALBERTA			Montreal	CFCF-FM	92.5
	KBAP-FM	96.3		KISW	99.9	Calgary	CHFM-FM	95.9		CJFM-FM	95.9
Gainesville	KGAF-FM	94.5		KIXI-FM	95.7	Edmonton	CFRN-FM	100.3		CJMS-FM	94.3
Houston	KBNO	93.7		KLSN	96.5	Red Deer	CKRD-FM	98.9		CKGM-FM	97.7
	KFMK	97.9	Tacoma	KZAM	92.5	<b>BRITISH COLUMBIA</b>			Quebec	CHRC-FM	98.1
	KLEF	94.5		KLAY-FM	106.1	Kamloops	CFFM-FM	98.3	Rimouski	CJBR-FM	101.5
	KODA-FM	99.1	<b>WEST VIRGINIA</b>			Penticton	CKOK-FM	97.1	Sherbrooke	CHLT-FM	102.7
	KRBE	104.1	Bluefield	WHIS-FM	104.5	Vancouver	CHQM-FM	103.5	Verdun	CKVL-FM	96.9
	KXYZ-FM	96.5	Charleston	WKNA	98.5	Victoria	CKLG-FM	99.3	<b>SASKATCHEWAN</b>		
Lubbock	KBFM	96.3					CFMS-FM	98.5	Saskatoon	CFMC-FM	103.9

# WHAT'S YOUR EQ?

Conducted by E. D. CLARK

## Current-Valve Circuits

Circuits A and B appear to be quite different. However, they have some-

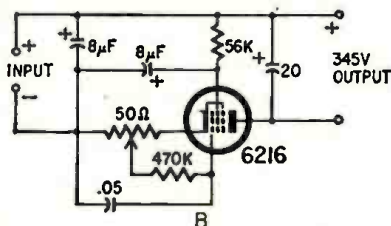
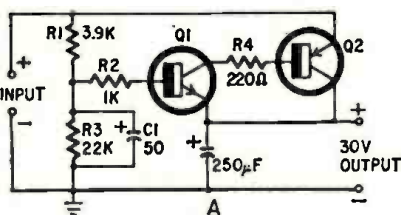

thing in common. Can you determine what?—Kendall Collins

## Deflection-Coil Puzzler

With a TV set operating normally, the letters shown in A appear on its screen.

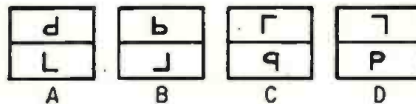

(1) If the leads to the vertical-deflection coils in the yoke are reversed while the horizontal-deflection coils are correctly connected, which picture (B, C or D) appears on the screen?

(2) If the leads to the horizontal-deflection coils in the yoke are reversed while vertical-deflection coils are correctly connected, which picture appears on the screen?

(3) If the leads to both the vertical and horizontal deflection coils are

reversed, which picture appears on the screen?—Robert P. Balin

## Switch-Pulse Circuit

Can you determine the voltage levels and waveshape of the pulse that is produced between terminals A and B when switch S is closed for one second and then opened? The sources' internal resistances are negligible.—Kendall Collins

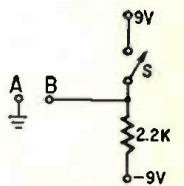

## 50 Years Ago

In Gernsback Publications  
In July 1916  
Electrical Experimenter

Secretary Daniels Radio-Phones to  
U.S. Battleship at Sea  
A New Telegraphone Dictating Machine for Business Offices  
Receiving Two Radio Messages on One Aerial  
A Listening-in Switch for Radio Receivers  
High Spark Frequency in Radio-Telegraphy

Three puzzlers for the student, theoretician and practical man. Simple? Double-check your answers before you say you've solved them. If you have an interesting or unusual puzzle (with an answer) send it to us. We will pay \$10 for each one accepted. We're especially interested in service stinkers or engineering stumbers on actual electronic equipment. We get so many letters we can't answer individual ones, but we'll print the more interesting solutions—ones the original authors never thought of.

Write EQ Editor, Radio-Electronics, 154 West 14th Street, New York, N. Y. 10011.

Answers to this month's puzzles are on page 89.

# Aligning the FM Stereo Radio

Much of the job is done before we come to the stereo section

By LEONARD FELDMAN



WITH FM STEREO BROADCASTING a mere five years old, millions of stereo-FM receivers are already in use. More than 400 FM stations are transmitting stereo part or full time. As FM stereo listening becomes more widespread, the need for professional servicing of the equipment increases proportionately.

While much has been written on multiplex circuit servicing and alignment, most of it has treated these subjects from the point of view of the decoder circuits alone. There has been little or no emphasis on the FM receiver as a whole. Yet, poorly aligned rf and i.f. sections of a stereo-FM receiver can often result in distorted reception, lack of separation and loss of stereo altogether. No amount of decoder realignment will correct those conditions.

We shall first analyze the steps that must be taken in the monophonic por-

tions of the receiver or tuner, so that the multiplex decoder circuits that follow will have a proper signal to work on.

Many excellent pieces of stereo-FM test equipment have appeared on the market during the last two years. They range in price from a popular kit at less than \$100 to completely wired units at around \$250. All these units have built-in rf generators that can be modulated by internally created stereo composite signals. Generally, the composite signal is also available separately, for checking decoder circuits alone, but with an rf signal you can align the set from "antenna terminals to speaker."

If you are fortunate enough to own an FM generator with an accurately calibrated rf attenuator, the best test setup for stereo-FM alignment will include both the FM and the multiplex generator. A typical setup using both pieces of equipment is shown in Fig. 1. The composite multiplex signal is used to modulate the FM generator externally. The generator, in turn, is connected to the antenna terminals of the receiver

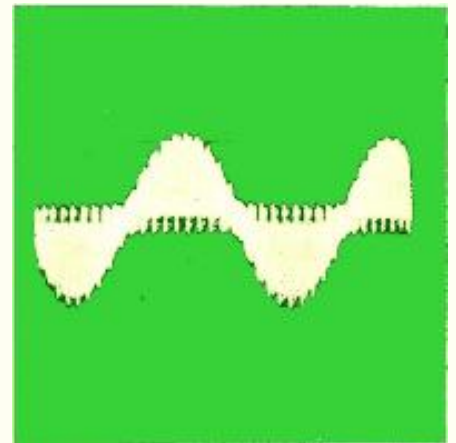

Fig. 2—Good left-only or right-only composite signal, as seen on scope connected at generator output or FM tuner detector.

under test. The applied rf signal can be reduced to a few microvolts, corresponding to the "weak-signal" conditions under which most FM-stereo reception problems occur.

The self-contained rf signal in most all-in-one generators usually cannot be attenuated enough to check weak-signal performance. Of course, coupling the rf leads loosely to the receiver can approximate weak-signal reception, but there is then no direct means of calibrating the number of microvolts actually applied. And a signal of 100  $\mu\text{V}$  leads to far different results than would a signal of, say, 10  $\mu\text{V}$ .

## Rf and i.f. alignment

A proper "left-only" composite signal, as recovered from a well-aligned FM tuner is shown in Fig. 2. (A "right-only" signal would appear the same on an oscilloscope presentation of this kind.) The features to be noted in this waveform are:

1. Good sinusoidal outline of the

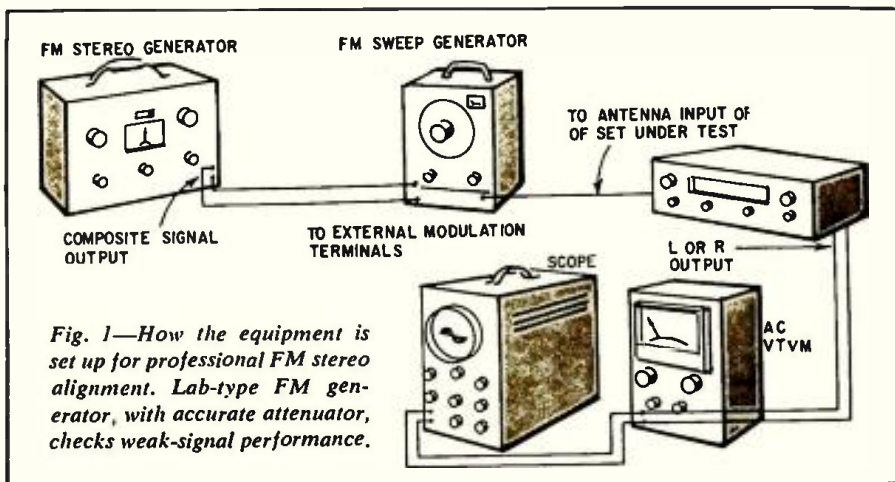

Fig. 1—How the equipment is set up for professional FM stereo alignment. Lab-type FM generator, with accurate attenuator, checks weak-signal performance.

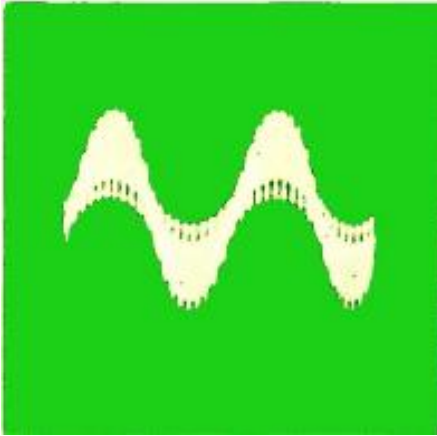

Fig. 3—Typical output from detector in which subcarrier component (L—R) is attenuated with respect to main carrier (L+R) component. Curved baseline is common.



Fig. 4—Severe phase distortion of recovered composite signal at FM detector caused by misalignment of i.f. circuits. This results in tremendously reduced channel separation.

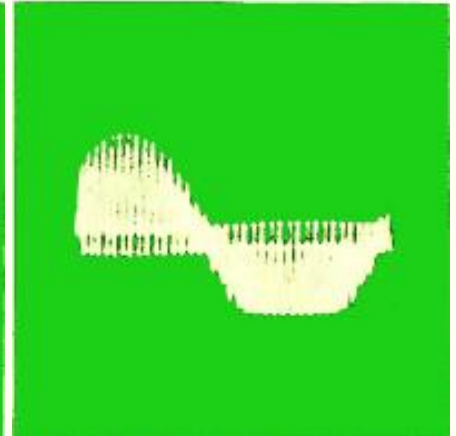

Fig. 5—This amplitude distortion of the recovered composite signal is caused by insufficient FM i.f. bandwidth, regeneration or oscillation in rf or i.f. circuits.

waveshape (no clipping or compression).

2. Clearly defined 19-kHz pilot carrier superimposed on the rest of the waveform.

3. Perfectly horizontal base-line (rather than curved or sawtooth baseline sections).

This is the type of signal that should be observed at the detector of a properly aligned FM tuner when an rf signal (modulated by a left-only composite signal from the multiplex generator) is applied to the antenna terminals of the receiver or tuner under test.

More often than not, some slight curvature of the baseline will be observed, as in Fig. 3. This indicates that the detector frequency response is deficient at the high-frequency end and that some of the high-frequency content of the composite signal (notably, the subcarrier sideband frequencies which range from 23 to 53 kHz) is being attenuated in the detector circuit or in its subsequent loading circuit. This does not necessarily indicate poor alignment, since compensating circuits in the following decoder may re-emphasize those highs. Should any of the other "defects" mentioned show up in the waveform, realignment is usually necessary.

Many manufacturers consider

fixed-frequency methods of rf and i.f. alignment to be adequate. The results of sweep alignment are generally more uniform and controllable. The main causes of distorted composite-signal at the detector of an FM tuner are "regeneration" and not enough i.f. bandwidth. Usually, regeneration (or oscillation) in a receiver will be more prevalent at weak signal inputs, because the tuner or receiver is operating at or near maximum gain. Regeneration of any sort in a tuner narrows or compresses the bandwidth of the i.f. circuits because it increases the effective Q of the total circuit, especially when the entire i.f. strip becomes an oscillator at 10.7 MHz. Recovery of high-frequency subcarrier

sideband components now becomes a hit-and-miss affair. Furthermore, what little subcarrier component is recovered is usually severely distorted, both in amplitude and phase, as shown in Figs. 4 and 5.

Fig. 6 shows a setup for sweeping an FM tuner or receiver. The modulating frequency voltage (usually 60 Hz from the FM sweep generator) is simultaneously applied to the horizontal input of the scope, which is set for external horizontal deflection. Modulate the generator more than  $\pm 75$  kHz and tune the set under test to the center frequency of the generator (any clear spot from 88 to 108 MHz). Apply 1,000  $\mu$ V of rf signal at the antenna terminals.

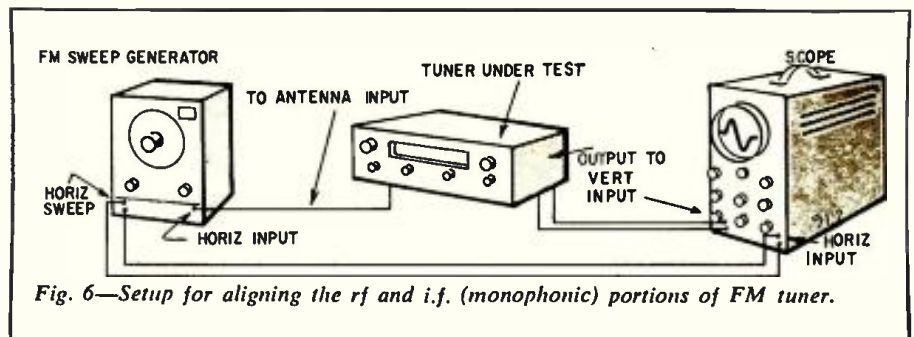

Fig. 6—Setup for aligning the rf and i.f. (monophonic) portions of FM tuner.

Such a strong signal will usually erase any traces of regeneration, and only a well-defined S-curve, as shown in Fig. 7, will be seen on the scope. Note that the linear portion of this curve is at least 150 kHz wide (usually even wider).

Next, reduce the signal applied to the antenna until the scope trace changes noticeably. The generator may require slight retuning as this is done. If the receiver is indeed marginally regenerative, the scope trace will suddenly "break" at some lower signal strength and look like Fig. 8. This indicates that the bandwidth is but a fraction of the 150 kHz required for good stereo reception. The i.f. transformers should be touched up slightly until the trace of Fig. 7 is restored (as nearly as possible). A good indication that no regeneration remains is the appearance of random noise on the scope screen when the generator is disconnected from the antenna terminals of the receiver. If the scope pattern shows some form of oscillation, the set is fairly certain to oscillate with a weak input signal.

#### Decoder-circuit alignment

Once we have a proper composite signal at the input to the decoder circuits of a stereo receiver, it is time to consider aligning these circuits. While decoder circuits may have one of two basic circuit configurations (the so-called "matrix" approach and the "time division" approach), certain points of alignment procedure are common to both.

Invariably, there will be some filter or trap arrangement for attenuating frequencies in the region of 67 kHz. If a 67-kHz signal is not available from your multiplex generator, it can be taken from an audio generator with a fair degree of accuracy. This is the *only* alignment signal that should be applied directly to the decoder input *without* going first through the entire receiver as modulation on an rf signal. In the block diagrams of Figs. 9 and 10, the 67-kHz signal would be applied at point A and a scope or ac vtm connected at point B. If the circuit under test uses a free-running type of local 19-kHz oscillator, disable it for this step.

Adjust the 67-kHz trap (usually a variable inductance) for *minimum* 67-kHz at point B. In matrix-type circuits (Fig. 10), this trap is usually adjusted in combination with the bandpass filter elements to give flat response from about 23 kHz to 53 kHz, followed by a fast attenuation to minimum output at 67 kHz. For matrix circuits, next adjust the low-pass filter with an audio oscillator connected to point A (Fig. 10) while reading the output at point H. Response should be flat from 50 Hz to 15 kHz, with a fast rolloff beyond that upper frequency.

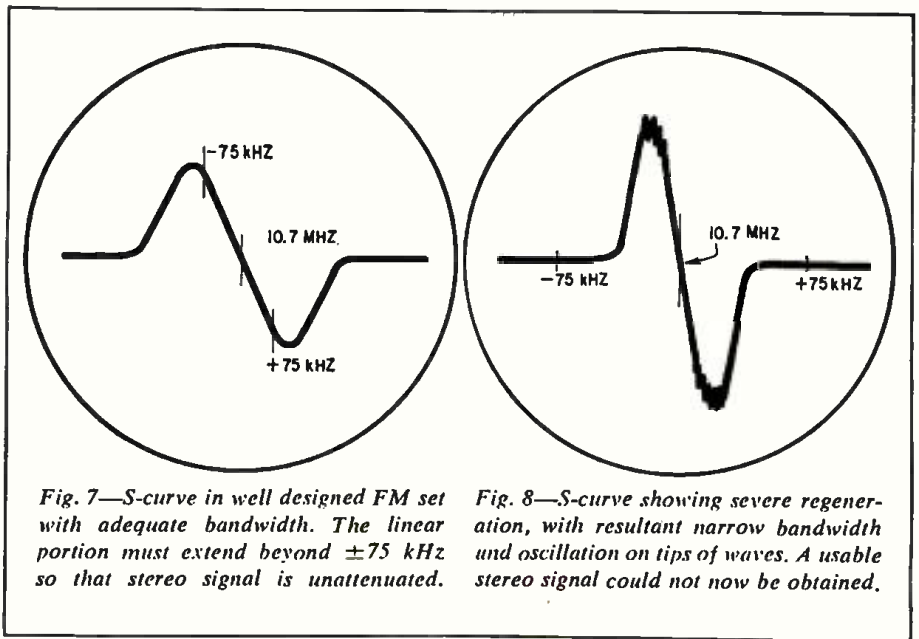

Fig. 7—S-curve in well designed FM set with adequate bandwidth. The linear portion must extend beyond  $\pm 75$  kHz so that stereo signal is unattenuated.

Fig. 8—S-curve showing severe regeneration, with resultant narrow bandwidth and oscillation on tips of waves. A usable stereo signal could not now be obtained.

In general, all these filter circuits should be optimized before attempting to align the carrier-restoration circuits or any of the final separation circuits. That is because each of the filters discussed thus far introduces some phase shift in the composite signal. These shifts will finally be compensated for by setting the carrier restoration (19 kHz and 38 kHz) section later.

#### 38-kHz regeneration

It would be beyond an article of this kind to analyze all the ways manufacturers create a suitable 38-kHz signal for the multiplex demodulating process. Some amplify and double the incoming 19-kHz pilot carrier signal. Others use the incoming pilot signal to trigger a local oscillator at 19 kHz, doubling the oscillator output to provide the 38-kHz carrier. Still others use the 19-kHz pilot signal to synchronize or lock a locally generated 38-kHz oscillator. We can break all these methods down into the

oscillator and nonoscillator types. In oscillator types, the oscillator stage itself should be disabled for these next steps.

With the modulated-rf sweep generator connected to the antenna terminals of the receiver, apply a 19-kHz signal from the multiplex generator strong enough to cause between 6 and 8 kHz of FM modulation of the carrier. See Fig. 1. Note the recovered 19-kHz pilot at point A (the input to the decoder circuits which is, in fact, the output of the FM discriminator or ratio detector). Examine the waveform at point C and adjust all tuned circuits associated with the 19-kHz amplifier stage(s) for maximum 19-kHz voltage at point C.

Restore the disabled local oscillator (if it had been previously disabled) and examine the output at point E. Adjust any tuned circuits relating to the oscillator or doubler to produce maximum waveform at point E. In locking-oscillator types, note that the output is actually *locked* in frequency by the incoming 19-kHz synchronizing signal. Lack

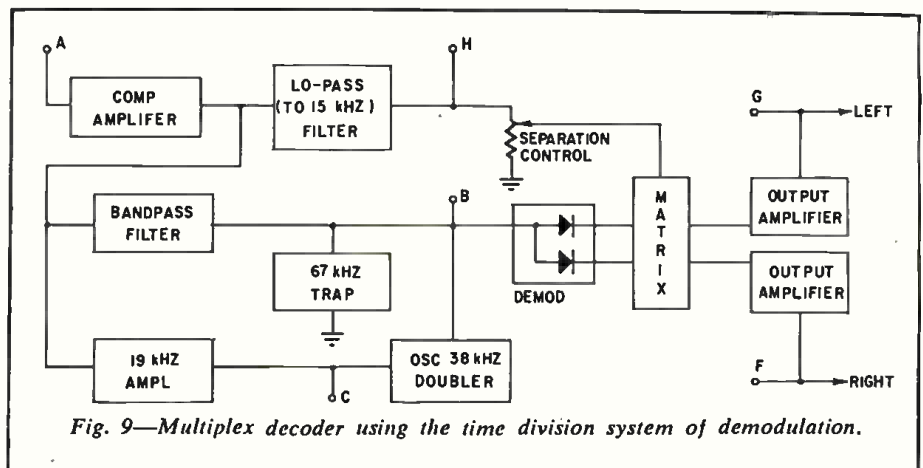

Fig. 9—Multiplex decoder using the time division system of demodulation.

of synchronization will be indicated by fuzziness of the waveform as well as by an audible motorboating or low-frequency tone from the speaker.

To insure lock-in at low signal strength, reduce the rf microvolts applied to the antenna until the local oscillator falls out-of-lock. Continue to touch up the tuned circuits until they lock in at the lowest possible input signal strength.

The resultant 38-kHz restored sub-carrier will look like Fig. 11. The reason for the alternate peaks and valleys is 19-kHz mixed with the 38-kHz carrier. This will not affect decoder performance and should not worry anyone.

### Separation adjustments

Now it is time to apply a complete composite signal to the receiver. Add a left-only or a right-only audio signal to the 19-kHz modulation already present, so as to modulate the FM generator to a total of about 45 kHz. This is the total amount of modulation you can get in practice with a left- or right-only signal. Full 75-kHz deviation occurs only when both left and right channels are fully modulated. If a right signal is being applied, examine the output at the *left* output terminal (G) and vice versa.

Slightly re-adjust all 19-kHz and 38-kHz tuned circuits for *minimum* output. This step is really a fine-tuning adjustment for these circuits to compensate for slight phase shifts, etc. Switch the input signal from the multiplex generator to the opposite channel and note an increase in output. The difference in the two outputs is the amount the decoder circuits can separate the two channels.

If there is a potentiometer-type separation control, adjust it now, reading the "null" side rather than the "high-output" side. Repeat the entire procedure on the opposite channel. That is, if a left signal was applied and you read the output null on the right, apply a right signal and read the null at the left output.

Often, the separation of the left channel will not equal that on the right. For example, the right channel, after adjustment, may show separation of 30 dB at mid-frequencies while the left channel may show only 20 dB of separation. It is best to compromise the settings in such cases so that each channel provides, say, 25 dB separation. This is done by touching up the separation control, as well as the 19-kHz and 38-kHz circuits.

As a final check of overall performance, you may want to check separation at some higher audio frequency, usually 5 kHz or 10 kHz. Don't be startled if the separation at the higher frequencies is considerably poorer than at mid-frequency. Most commercial decoder circuits behave that way. It is rare indeed

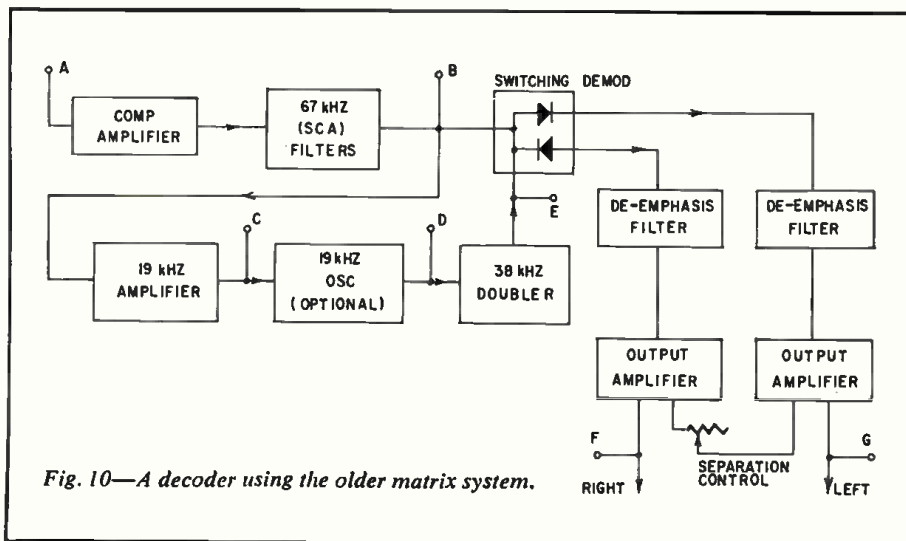

Fig. 10—A decoder using the older matrix system.

to find a stereo receiver that can maintain 25 or 30 dB of separation all the way from 50 Hz to 15 kHz.

### Proof of performance

You may well find—even after you have carefully gone through all the steps above—that stereo reception leaves much to be desired. Common problems include noisy reception in stereo (while mono reception of the same station is noise-free) and a persistent sibilant or harsh sound in spoken words containing the letter *s*. These problems probably have nothing to do with your just-completed alignment. Good reception of stereo-FM usually needs a rf signal much stronger than for monophonic FM. Also, the distortion can often be due to multipath reflections (like ghosts in TV reception).

If these ills are to be cured at all, it will be with a properly selected and installed outdoor FM antenna. While many FM listeners will resist this solution at first (having become accustomed to good mono FM without such an in-

stallation), it is the only solution in a great many cases.

### Beacons, indicators and automatic switches

In general, such refinements as visual stereo indicators, lights, etc. depend on the incoming 19-kHz signal for their operation. Thus, if all the circuits associated with the pilot signal have been peaked, the visual indicator should work automatically (barring a burnt-out light bulb!). But some beacon or light circuits have tunable coils of their own which also need to be peaked. Such needs can best be learned from the schematic and service instructions.

Automatic switching from FM to FM-stereo also depends on receiving a 19-kHz signal, which of course means that an FM stereo signal is being transmitted. Here, too, you must refer to the receiver schematic, since there are a great many variations.

### Off-the-air alignment

It has been suggested that any stereo broadcasting station can serve as a ready-made multiplex-and-rf generator. To some extent, that is true. Certainly, a very precise 19-kHz signal is available and can be used for peaking the 19-kHz and 38-kHz circuits as previously outlined. Unfortunately, however, the signal from a given station will be at a single level of strength, giving you only doubtful ways to check weak-signal or strong-signal performance. Then, too, separation can't be judged on ordinary program material (unless an announcer is kind enough to speak for long periods of time on one channel only and tells the listeners he is doing so).

To sum up, some cursory alignment steps can be made using a station as a signal source, but for a professional alignment job, you will need an FM-multiplex generator.

END

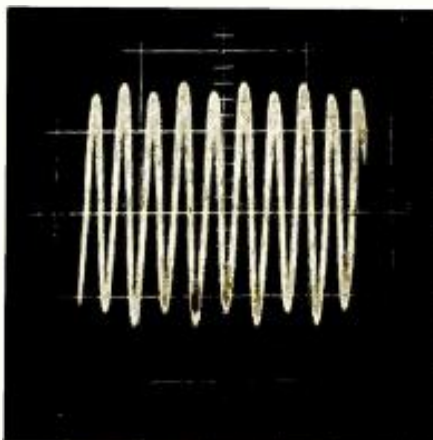

Fig. 11—Typical 38-kHz signal in decoder circuits. Larger alternate waves show the presence of some residual 19-kHz signal.

**Complimentary OutPut circuit uses rugged silicon transistors—excellent performance without rare parts or difficult adjustments**

By **RICHARD J. DE SA**

FIFTEEN YEARS AGO JIM LANGHAM, IN a dandy little book<sup>1</sup> now out of print, wrote "... feedback reduces distortion, broadens the frequency band, makes circuits more stable and more linear, lets you change the effective output impedance, and a lot of other things. It can make a crummy amplifier sound just peachy. But it shouldn't! *It should make a good amplifier sound better!*"

That statement impressed me profoundly. I remember it again and again as I see many modern transistor power amplifiers in which nonlinear, asymmetric circuits with 4% or 5% distortion are made acceptable with large amounts of negative feedback. I decided to use, for my home music system, a circuit with low distortion and good performance engineered into the design, so that feedback could make it better, not just acceptable.

The complementary, single-ended emitter-follower amplifier in Fig. 1-a has such a circuit. (Shown in Fig. 1-b is the asymmetric circuit currently popular.) This circuit has not been widely used because it has not been easy to get suitable transistors.

K. H. Sueker<sup>2</sup> described, in late 1964, a dual 30-watt power amplifier with an n-p-n silicon and a p-n-p germanium transistor in the complementary output circuit. I felt that the very limited high-frequency performance of high-power p-n-p germanium units made them less than ideal in such a circuit, and decided to wait until a suitable silicon p-n-p transistor became available at a down-to-earth price.

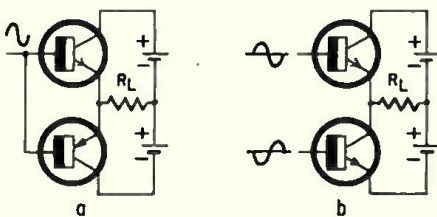
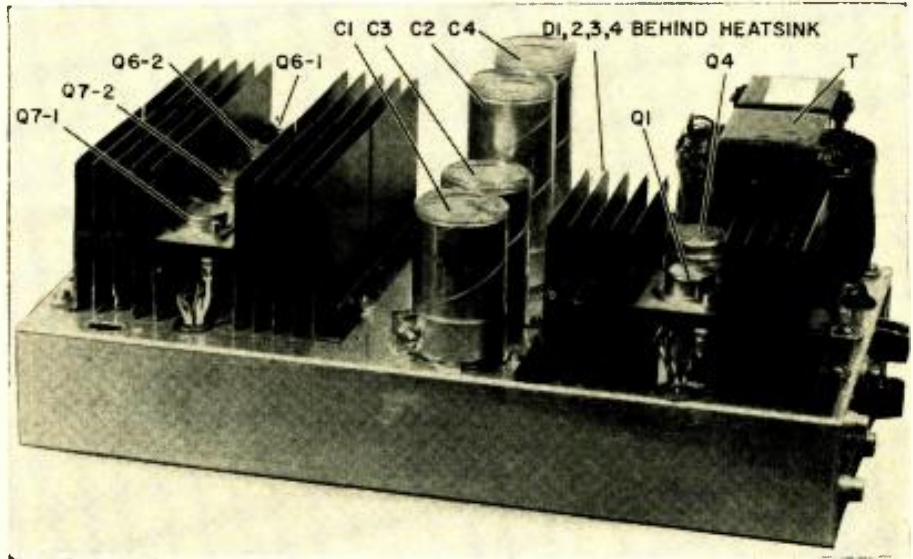

Fig. 1-a—Complementary emitter-follower output with n-p-n and p-n-p transistors. b—Asymmetrical "single-ended push-pull" circuit that uses two n-p-n transistors.

<sup>1</sup>James E. Langham, *High Fidelity Techniques*, Gernsback Publications, Inc., 1950.

<sup>2</sup>Keith H. Sueker, "The 'Transistor Williamson' Stereo Power Amplifier," *Electronics World*, October 1964, p. 42.



Performance data for this remarkable power amplifier are on page 50.

# Build a COP 30/30

Fortunately, Motorola recently announced the availability of a 150-watt, 10-ampere p-n-p silicon transistor—the 2N3789—with an  $f_t$  of 4 MHz. Its cost—under \$9.

Silicon transistors are highly desirable for a number of reasons: much better performance at high temperatures than germanium (with resultant simplification of bias circuits), high  $f_t$  (gain-bandwidth product), elimination of "tunnel-through" breakdown problems, and—now—reasonable cost.

This amplifier is the result of my efforts to use the 2N3789 with the rugged and popular 2N3055 n-p-n silicon transistor in a complementary output. The amplifier is straightforward and eas-

ily constructed. Performance, as substantiated by the test data, is excellent. If top quality parts are used throughout, total cost is about \$90. The amplifier uses no special components—all parts can be obtained readily.

## The circuitry

Fig. 2 is the complete circuit of one of the stereo channels. The dual-polarity power supply used to power both channels is shown in Fig. 3.

The power supply is unusual in two respects: It is more elaborate than most—reliable performance cannot be obtained with unregulated or poorly regulated supplies. The reference voltage for both plus and minus polarities is ob-

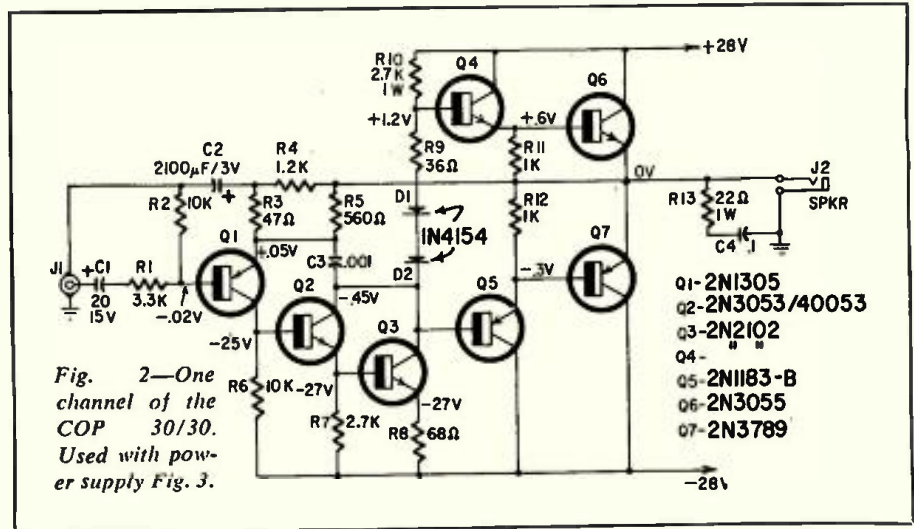

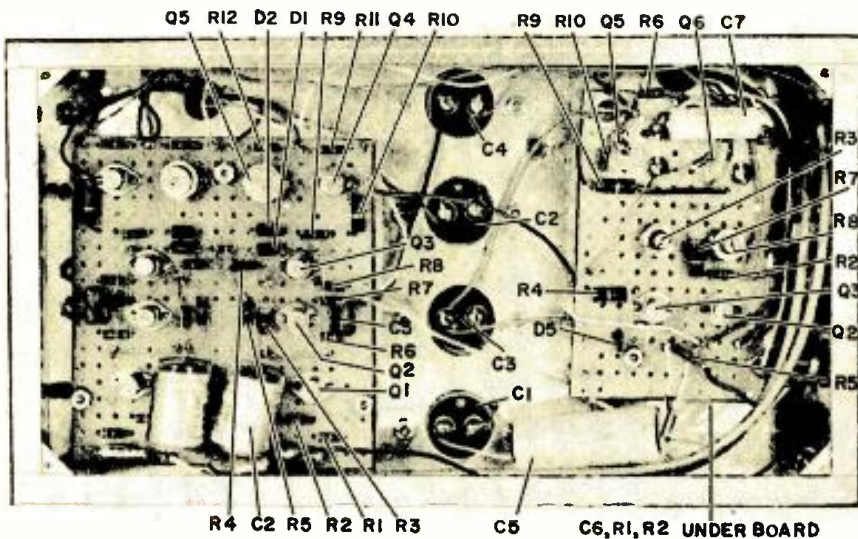

Underneath the COP 30/30: wiring is on perforated boards, easy to check.

- Amplifier Parts List (one channel only; double all items for stereo amplifier)**
- C1—20  $\mu$ F, 15 volts, electrolytic capacitor
  - C2—2,100  $\mu$ F, 3 volts (Sprague type 39D 218G003HE4 or equivalent)
  - C3—.001  $\mu$ F, ceramic or mica
  - C4—0.1  $\mu$ F, 50 volts, ceramic or paper
  - R1—3,300 ohms
  - R2—10,000 ohms
  - R3—47 ohms
  - R4—1,200 ohms
  - R5—560 ohms
  - R6—10,000 ohms
  - R7—2,700 ohms
  - R8—68 ohms
  - R9—36 ohms 5%
  - R10—2,700 ohms, 1 watt
  - R11, R12—1,000 ohms
  - R13—22 ohms, 1 watt
- All resistors  $\frac{1}{2}$  watt, 10% except R9, R10, R13
- D1, D2—general-purpose silicon diodes (1N4154 or equivalent)
  - Q1—2N1305 (TI, G.E., RCA)
  - Q2—2N3053/40053 (RCA)
  - Q3—2N2102 (RCA)
  - Q4—2N183B (RCA)
  - Q5—2N3055 (RCA, Motorola)
  - Q6—2N3789 (Motorola—catalog No. 22F4388, \$8.90, Newark Electronics Corp., 223 W. Madison St., Chicago, Ill. 60606)
  - J1—phono jack
  - J2—open-circuit phone jack

# Transistor Stereo Amplifier

tained from just one wide-tolerance Zener diode, which means a considerable saving in cost. The voltage supply to the Zener is obtained after F1; so, if that fuse blows, the reference voltage drops, shutting off both supply voltages.

The power supply has ample power to drive the two channels to 30 watts output into 8 ohms.

The major difference between this amplifier and other high-power units is the output circuit. Q6 and Q7 (Fig. 2) are high-current silicon transistors con-

nected to the speaker as emitter followers. Q6, an n-p-n unit, conducts only on positive signals, coupling the signal to the speaker with a voltage gain of slightly under 1 and a high current gain, and simply cuts off on negative signals. Q7 amplifies negative signals and cuts off on positive ones. Therefore operation is push-pull (or, more accurately, push-push). The complementary n-p-n/p-n-p arrangement makes phase inversion automatic.

Q4 and Q5 are arranged in the

Chassis, 7 x 13 x 2 in. (one only for entire amplifier and power supply—Bud AC409 or equivalent)

Heat sinks (3 for entire amplifier and power supply)—Delco 7281366 (Delco distributors)

Mica insulating washers—4 for 1N1613 rectifiers, 1 for TO-3 style transistor, 1 for TO-36 style transistor

Teflon insulating washers for mounting heat sinks—8 required

**Power supply parts list (for two channels)**

C1, C3—2,600  $\mu$ F, 50 volts, electrolytic (Sprague 36D 262G050AB)

C2, C4—1,300  $\mu$ F, 50 volts, electrolytic (Sprague 36D 132G050AA)

C5—500  $\mu$ F, 25 volts, electrolytic (Sprague TVA 1208 or equivalent)

C6, C7—150  $\mu$ F, 35 volts, electrolytic (Mallory MTA 150F35 or equivalent)

D1, D2, D3, D4—silicon rectifiers, 5 amperes, 100 PIV (RCA 1N1613 or equivalent)

D5—22-volt Zener diode, 20%

F1, F2—fuse, 2 amperes, slow-blow

Q1—2N3055 (RCA)

Q2—2N3053/40053 (RCA)

Q3—2N1302 (RCA, TI)

Q4—2N443 (Delco, Motorola, RCA)

Q5, Q6—2N376A (Motorola)

R1, R6, R10—1,000 ohms

R2—100 ohms

R3, R8—200-ohm pot (Mallory MTC miniature trimmer control)

R4—470 ohms, 1 watt

R5—180 ohms

R7—1,000 ohms, 1 watt

R9—1,200 ohms, 1 watt

All resistors  $\frac{1}{2}$  watt, 10% except R3 and R8

T—transformer, 56-volt ct. 2-amp secondary.

Signal 56-2 or equiv. Signal Transformer Co., 1661 McDonald Ave., Brooklyn, N.Y.

\$8.80 plus postage. 4 weeks delivery.

Mounting rings and insulating sleeves for C1-C4

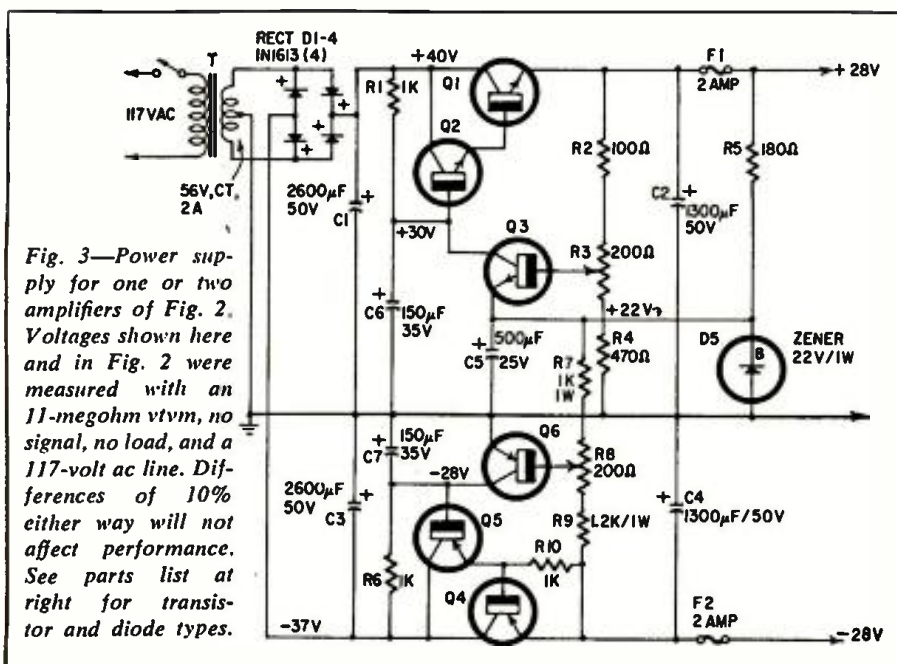

Fig. 3—Power supply for one or two amplifiers of Fig. 2. Voltages shown here and in Fig. 2 were measured with an 11-megohm vtvm, no signal, no load, and a 117-volt ac line. Differences of 10% either way will not affect performance. See parts list at right for transistor and diode types.



Fig. 4—Square waves through 30/30: left to right 20, 2,000, 20,000 Hz. Lower trace in each picture is input waveform. The output load is 8 ohms in each case.

#### PERFORMANCE FIGURES FOR THE COP 30/30

Measurements involving power and distortion were made with both amplifier channels operating simultaneously, each driving a separate 8-ohm load.

##### Frequency response:

30 watts into 8 ohms:  $\pm 0$ ,  $-\frac{1}{2}$  dB from 6 to 65,000 Hz

3 watts into 8 ohms:  $\pm 0$ ,  $-\frac{1}{2}$  dB from 5 to 100,000 Hz

Power bandwidth:  $\pm 3$  dB 2 to 40,000 Hz (8-ohm load)

Input impedance: 13,000 ohms; 100,000 ohms with circuit of Fig. 6 added at inputs

Input sensitivity: 1.7 volts rms across 13,000 ohms or 100,000 ohms for 30 watts output across 8 ohms

Hum and noise: more than 85 dB below 30 watts output across 8 ohms

Output impedance: approximately 0.1 ohm at any frequency within bandpass. (Damping factor 80 for 8-ohm speaker)

##### Distortion:

Harmonic: less than 0.3% total harmonics at any frequency from 20 to 20,000 Hz at 30 watts output. (0.1% or less at mid-frequencies and moderate power levels.)

Intermodulation: less than 0.4% at 30 watts equivalent sine-wave power, measured with 60 and 6,000 Hz mixed 4:1

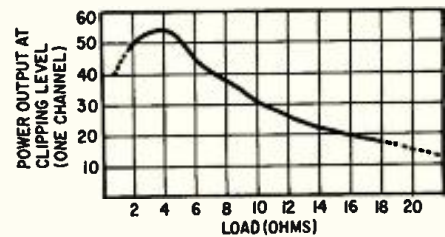

Fig. 5—Power output vs load resistance.

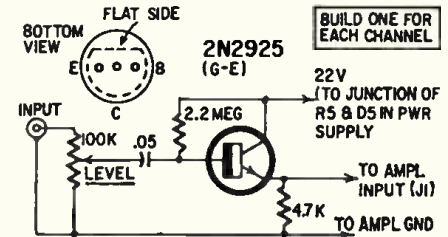

Fig. 6—Emitter follower raises input impedance of amplifier to 100,000 ohms so it can be fed by any preamplifier. Level control can be replaced by fixed resistor.

Darlington circuit for the current gain needed to drive the output transistors. R11 and R12 help stabilize the Darlington pairs.

Q4 and Q5 are driven by Q3, which supplies a large share of the total voltage gain of the amplifier. Relatively low-value resistors are used to bias this stage. This provides a low-impedance drive for Q4 and Q5. Forward-biased diodes D1 and D2 and resistor R9 set the proper bias for the output transistors. This sets the idling current and eliminates crossover distortion (which, indeed, is absent at any frequency or power level). The diodes also provide some degree of temperature compensation by adjusting the quiescent bias of the output transistors as ambient temperature varies.

Transistor Q2 is connected to Q3 in the Darlington connection and serves to increase the input impedance to Q3. Q1 is a conventional voltage amplifier, except its emitter resistor (R3) is returned to the junction of C2 and R4 instead of to ground. C2 and R4 act as a filter which strips the ac signal from the output, but retains dc feedback to maintain the output offset voltage at less than 0.2 automatically.

About 36 dB of feedback from output to input is provided by R5 and R3. This high feedback level is possible because the gain of the amplifier without feedback is more than 1,600. High-frequency oscillation is prevented by feedback via C3.

High-frequency response can be adjusted to suit individual taste by varying the value of C3, although at least 800 pF is required to prevent high-frequency oscillation. The .001  $\mu$ F value shown gives a square-wave rise time of about 2  $\mu$ sec.

#### How it puts out

The table lists some of the performance specifications of the amplifier. The output impedance is less than 0.10 ohm from 20 to 20,000 Hz, which means the damping factor for 8-ohm speakers is more than 80. This low output impedance, of course, is one of the qualities of the complementary emitter-follower output and results in excellent speaker control. Since a dual-polarity power supply is used, no coupling capacitor between the amplifier and speaker is needed. This contributes to good phase linearity down to subaudio frequencies.

#### The wider the band . . . ?

The question of bandwidth of power amplifiers has been vigorously debated in the literature for many years.<sup>3</sup> The "narrow bandwidthers"<sup>4</sup> argue that one can hear only from about 20 to 20,000 cycles per second and that bandwidth should be adjusted to cover no more than this range so that inaudible frequencies will not be amplified. However, I personally agree with Myers and Kahn<sup>5</sup> who point out that this is true, but that the way to evaluate amplifier response within this frequency range is with square waves and not sine waves. Musical material contains few sine waves but is full of ragged transients and irregular waveforms which square waves simulate far better than do sine waves.

Of course, very wide bandwidth combined with high phase linearity is

<sup>3</sup>Robert E. Furst vs Victor Brociner, "The Wider the Band, the Higher the Fi?" Radio-Electronics, March 1966, p. 50.

<sup>4</sup>D. R. von Recklinghausen, W. A. Linder, and E. H. L. Mason, "Transistors for Hi-Fi—Panacea or Pandemonium?" Electronics World, Sept. 1963, p. 37; Oct. 1963, p. 38.

<sup>5</sup>Myers and Kahn, Audio, Jan. 1963, p. 21.

required to reproduce 20–20,000-cycle-per-second square waves faithfully. Performance of the 30/30 in this respect is verified by the oscilloscope traces reproduced in Fig. 4.

The effect of load impedance is shown in Fig. 5. Note that up to 56 watts can be delivered to a 4-ohm load, because supply voltages are relatively low. Maximum power into 16 ohms is down to 20 watts. If the unit is to be used only with 16-ohm speakers, power availability can be increased to 25 watts by setting the plus and minus supply voltages to 32 volts instead of 28 (see below).

#### A few how-to-build-it hints

Start construction by drilling the chassis (use the photos as guides) to mount the input and output jacks, fuse holders, power transformer and C1–C4. I placed all the jacks and fuse holders at one end of the chassis because of the physical arrangement of my stereo cabinet; of course other arrangements can be used. Also, I eliminated an on-off switch because the amplifier is operated from ac switched from a central control panel in my setup. The power-supply transistors (Q1 and Q4) are mounted on an extruded aluminum heat sink with mica insulating washers, and with Teflon washers on the mounting bolts. The remaining power-supply transistors and other components are mounted on a piece of Vectorboard which is mounted on  $\frac{1}{2}$ -inch standoffs under the chassis. Diodes D1–D4 are mounted with mica washers to insulate them from the chassis.

After the power supply is wired and checked carefully, it can be turned on and adjusted. Adjust R3 so that B+



is 28 volts and R8 so that B— is also 28 volts (both with respect to chassis ground). Adjust to  $\pm 32$  volts if 25 watts is desired for 16-ohm speakers.

The output transistors are mounted on the heat sinks without insulation since the heat sinks are themselves insulated from the chassis. Transistors Q6 for the two channels are mounted on one heat sink and Q7 for both channels on the other. I find it convenient to tap the holes in the mounting flanges of the output transistors with a 10-32 tap so that they can be mounted with no need for retaining nuts. If you decide to do likewise, the mounting holes on the pre-punched heat sinks will have to be enlarged with a No. 11 drill to accept a 10-32 bolt.

The heat sinks are mounted on the

chassis with standoff Teflon insulators. I used clips broken out of 9-pin miniature tube sockets to make connections to base and emitter pins of the output transistors, although one can readily solder directly to the pins.

The low-level stages of the amplifier can be constructed as the builder desires; I used Vectorboards with components mounted on press-in clips. This type of construction is rugged and neat, yet not as permanent as printed circuits, making future repairs or circuit changes much easier. The parts layout can be seen in the photos.

After carefully checking all wiring the amplifier is ready for test and use. No special care is needed during testing; the unit can be operated at full power for extended periods at any frequency

within the bandpass without danger. It is not harmed when operated into an open circuit, and a shorted output will simply blow the fuses—the output can be shorted even during full-power operation with no harm whatever. Operation into a short for 4 or 5 seconds will blow the fuses.

The sound delivered by this unit may well surprise you, particularly if you now use a tube amplifier of less than absolutely top quality. The bass is extremely solid and tight—the amplifier seems to “grab hold of” the speaker and reduce resonances and spurious signals. The highs are crisp, sharp, very well defined. If top-quality components are used throughout, the amplifier will maintain its superior performance for many years. END

## Souping Up Your All-Band Transistor Portable

By JOHN POTTER SHIELDS

RECENTLY, A NUMBER OF PORTABLE transistor receivers covering short-wave as well as standard broadcast frequencies have appeared on the market. They offer considerably more in the way of performance than the six-transistor shirt-pocket wonders. This new breed of receiver has much to offer the SWL—and even the ham.

An example is the Nordmende Globetraveler receiver, which I've been using for some time now. An excellent performer, it has AM coverage from 200 kHz to 30 MHz, plus the FM broadcast band. Shortly after purchasing the receiver, I decided that a few relatively simple additions would considerably enhance its use as an all-around SWL receiver. These improvements, which can be added to any receiver of the general multiband variety, result in considerably more enjoyment from the set. Let's see what can be done.

Most multiband receivers have connections for an external antenna. The connection is usually a miniature banana jack. The length of the antenna can be determined by the particular band you want to receive; a single wire, as high as

possible, clear of all objects such as trees, is pretty hard to beat.

An equally important addition is a good ground. Since battery receivers are not capacitively grounded through the power line as are line-operated sets, a good external ground reduces noise and increases signal strength, particularly at the lower frequencies.

There are two ways to put a satisfactory ground on your portable receiver. One (Fig. 1) makes use of a cold-water pipe as the ground. This is best. A lead as short as possible from the chassis of the receiver will do the trick. An easy way to get electrical access to the receiver's chassis without butchering the set is to use the chassis-common conductor of one of the accessory jacks as the ground connection as shown in Fig. 1. The outer conductor of these jacks is almost always connected to chassis either directly or through an isolating capacitor. This capacitor will not hamper the grounding. An exception may be the ear-phone or “external speaker” jack, which may not have either side grounded.

The results from an external antenna can be increased considerably by adding an antenna trimmer. Perhaps the simplest way to do this is as shown in

Fig. 2 and the photo. The smaller section of a two-section superhet cut-stator variable capacitor is connected in series with the receiver's external antenna lead.

Peak the antenna trimmer for best reception on any particular station.

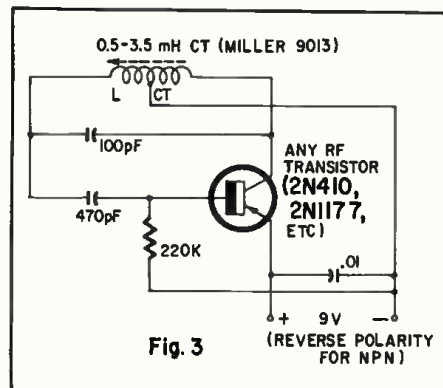
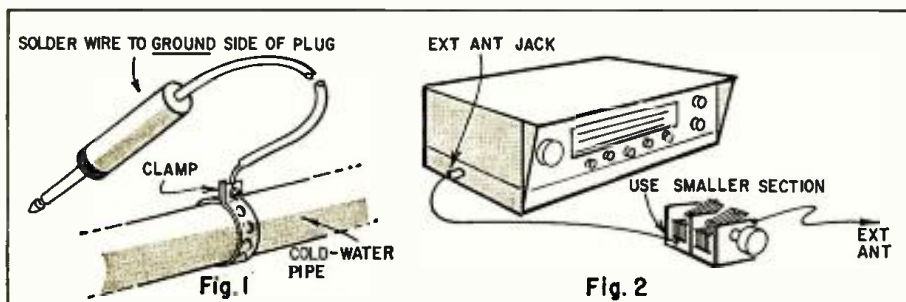

No SWL receiver would be worth its salt without a bfo so that CW (code) and SSB signals can be received. It is possible to add a bfo to your receiver without altering its insides. The little transistor bfo, whose schematic is shown in Fig. 3 need only be placed close to the receiver. Its signal radiates into the receiver.

The bfo is a series-fed Hartley oscillator. The wiring and parts values aren't critical.

With power applied to both receiver and bfo, tune in a station on the receiver and adjust the slug in the bfo's oscillator coil (L) until you hear a whistle. Adjusting L further, you should be able to go through zero beat and produce a rising-pitch whistle on the other side. L's slug can be fitted with a small knob to make adjusting easier. The knob is then the bfo pitch control. END

# Hunting Down Trouble In Stereo Receivers

The systematic way to tie the symptoms to the causes.

By WILLIAM KRUEGER\* and E. F. RICE



TROUBLESHOOTING stereo multiplex efficiently depends on knowing key tests to apply for each symptom. Here we will show you how to analyze several symptoms, and give key test points for locating faults quickly. We'll also look at alignment in detail.

The basic idea of *time-division* multiplex detection (also called *switching* or *envelope* detection) is illustrated in Fig. 1. The composite signal containing  $L + R$  and  $L - R$  is switched between the left and right output terminals at a rate of 38 kHz. Only the  $L - R$  signals change polarity on alternate halves of the 38-kHz cycles because  $L - R$  consists of sidebands of the 38-kHz subcarrier. The carrier itself is suppressed at the transmitter. After the switching,  $L$

$- R$  is added to  $L + R$  to form the left-channel output. The negative version,  $-(L - R)$  or  $-L + R$ , is added to  $L + R$  to produce the right channel.

For many symptoms, the choice of tests depends on the method used in the multiplex circuit to obtain the 38-kHz switching voltage. The block diagrams of Fig. 2 show how the transmitted 19-kHz pilot signal can simply be amplified and doubled to 38 kHz. Or, the 19-kHz signal may be used to phase-lock a self-excited oscillator running at 38 kHz, or sometimes the 19-kHz pilot is first doubled to 38 kHz and then used to sync the oscillator.

## Listener's complaint

The most common problem stereo-FM listeners have is a background hiss on stereo stations, while monophonic stations are clear. This is atmospheric noise, and noise from the receiver's

front-end stages, beating with the 38-kHz switching voltage. When the receiver uses a 38-kHz oscillator that runs continuously, there may be a hiss on all stations, mono or stereo.

The cure is the same as you would recommend for a TV viewer troubled with snow on the screen: improve the signal-to-noise ratio by improving the antenna system. TV antennas, and the so-called "line-cord" antennas, which may work well enough for mono FM reception, are not usually satisfactory for stereo. This is because the composite signal is more susceptible to the effects of low signal strength. Also, operating a TV antenna in the FM band causes very high SWR, producing phase shift in the 23- to 53-kHz ( $L - R$ ) sidebands. Loss of channel separation is the result.

Besides the hissing noise and poor separation caused by an inadequate antenna, weak signals may be distorted because phase-locked oscillators need a certain minimum amplitude. This means that some stations may sound normal, but others at whose frequency there's a high SWR may be distorted.

As with color TV (which is also a multiplex system), a strong input signal to the receiver without attenuation of certain frequencies and without phase-shifted reflections (ghosts) from nearby objects is terribly important.

There are three common causes for this symptom: (1) unequal forward and reverse resistance in the switching diodes; (2) incomplete doubling from 19 to 38 kHz; (3) defect in the 38-kHz input transformer that drives the switching diodes.

The diodes can be checked easily with an ohmmeter by reading their resistance in one direction and reversing the probes for another reading. A ratio of 5 to 1 is good enough, but 10 to 1 is better. The actual value is not as important as having the same ratio in all diodes. This is an easy fault to find. Just remember to use the same range on the ohmmeter for all readings.

If your scope shows a waveform like Fig. 3 at the output of the 38-kHz generator, you have incomplete doubling. Check at the base or grid of the oscillator for a symmetrical signal. It may not be a sine wave if a full-wave

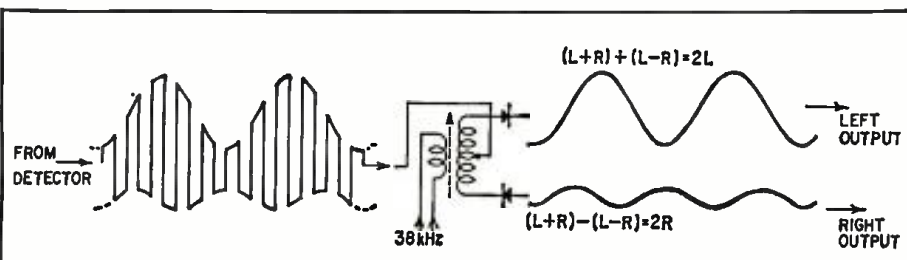

Fig. 1—Simplified scheme of envelope detection. Opposite edges of 38-kHz switching waveform carry the left and right channels.

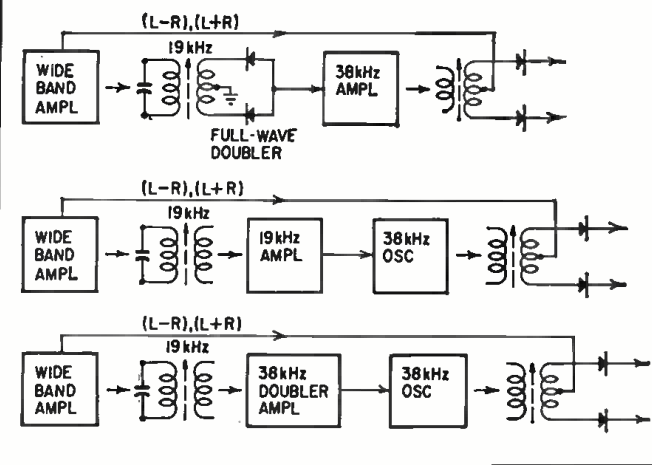

Fig. 2—Three ways of winning back a properly phased 38-kHz subcarrier.

rectifier is used for doubling, but the pulses should be symmetrical. Fig. 4 shows what to expect. If you don't find the correct signals, suspect D1 or D2, C1, Q1 or Q2, or T1, depending on where you find the wrong waveform.

When all waveforms are normal, and the switching diodes check OK, try a new transformer for T2.

### Poor sync

This causes distortion in both channels, and for reasons different from the ones mentioned for single-channel distortion. So to be sure you are on the right track: disconnect each speaker separately and listen for distortion. Extreme cases have a low-pitched growling sound which seems to respond to adjustment of the 19-kHz phase. But, unless someone has merely misadjusted the control, more extensive repairs will be needed to restore good separation and assure that the sync will not fail again.

Fig. 5 illustrates an interesting case where loss of sync was caused by a defective component. The signal was normal on mono but distorted on stereo, and the stereo indicator lamp blinked intermittently. After determining that both channels were affected, the technician attempted to touch up the alignment of the 19-kHz tank, L13. The tuning was so critical that a quarter turn of the slug produced a low growling sound. With some difficulty, the growling sound was finally brought to zero-beat and the receiver operated for a few minutes without distortion, but with very little separation. But it soon went out of sync again.

One end of the 100K resistor, R, was temporarily disconnected to eliminate the possibility of excessive loading on the 19-kHz doubler output by a defect in the indicator circuit. This made no difference.

The waveform at the collector of Q3 was unstable in frequency, quite low in amplitude, and showed unequal and asymmetrical peaks characteristic of incomplete doubling. As a result, all voltages at the terminals of Q2 and Q3 were checked. The collector of Q2 had only 4 volts, which indicated that Q2 might be defective.

There are three ways to spot a transistor with excessive collector-to-emitter leakage:

1. Its emitter voltage is too high.
2. It is warm after a few minutes' operation.
3. Its collector-to-emitter voltage is low.

The final check for leakage is to measure the collector voltage while you short the base to the emitter. If the transistor is OK, its collector current will be cut off, giving a sudden rise in collector voltage. This test was applied to Q2 and

the collector voltage jumped up to 10.8, indicating no leakage.

This all pointed to trouble in the collector circuit of Q2, so the ohmmeter was touched across L14. That was it—4,700 ohms! The coil was open. The 4,700 ohms permitted some signal input to Q3, but very little, resulting in a weak, unstable and asymmetrical signal driving the switching diodes.

The symptom that clearly indicates the need for complete alignment is when the left channel, for example, produces a "left only" signal, but the right channel is monophonic. This is a very common symptom even in new units, and is often mistaken for poor separation when there may in fact, be excellent separation on

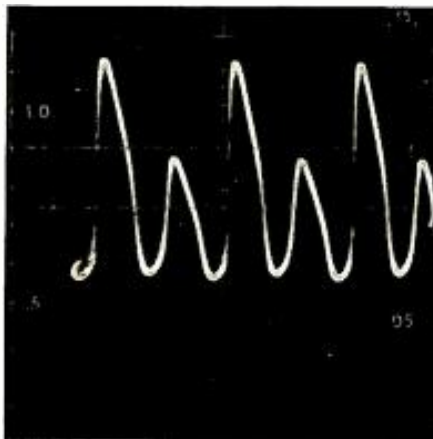

Fig. 3—If you find a waveform like this at the collector (or plate) of the 38-kHz generator, it signifies incomplete doubling.

one channel. The remedy is a thorough alignment of the tuner, i.f.'s, ratio detector or discriminator, and the multiplex circuits.

Many troubles in stereo multiplex receivers can be cured by careful alignment. So let's look at the procedure in detail.

A stereo generator is practically a necessity, not only for the special stereo signals it provides but also for the composite rf output, which you can use instead of a regular sweep generator to align the i.f. stages. If you have ever aligned an FM receiver with a standard sweep generator, you will appreciate the convenience of working with a stereo generator. You may be surprised to find that we do not strive for the best overall shape of the response curve. For good stereo reception we are mainly interested in getting the 23- to 53-kHz (L - R) signals through the tuner and i.f.'s with a minimum of phase shift or attenuation.

Start by tuning the 67-kHz trap for minimum output on a scope or vtvm connected to the output end of the trap while feeding 67 kHz to the base or grid of the first stage in the multiplex section.

Next, feed the composite stereo signal from the generator to the receiver's antenna terminals through 120Ω resistors in series with each lead. Fig. 6 shows the waveforms you will get at the audio output terminals of the FM detector stage. Adjust the i.f. transformers and the detector transformer to get the center line as flat as possible (Fig. 6-a). Considerable attenuation of L - R is indicated by the wavy base in Fig. 6-b.

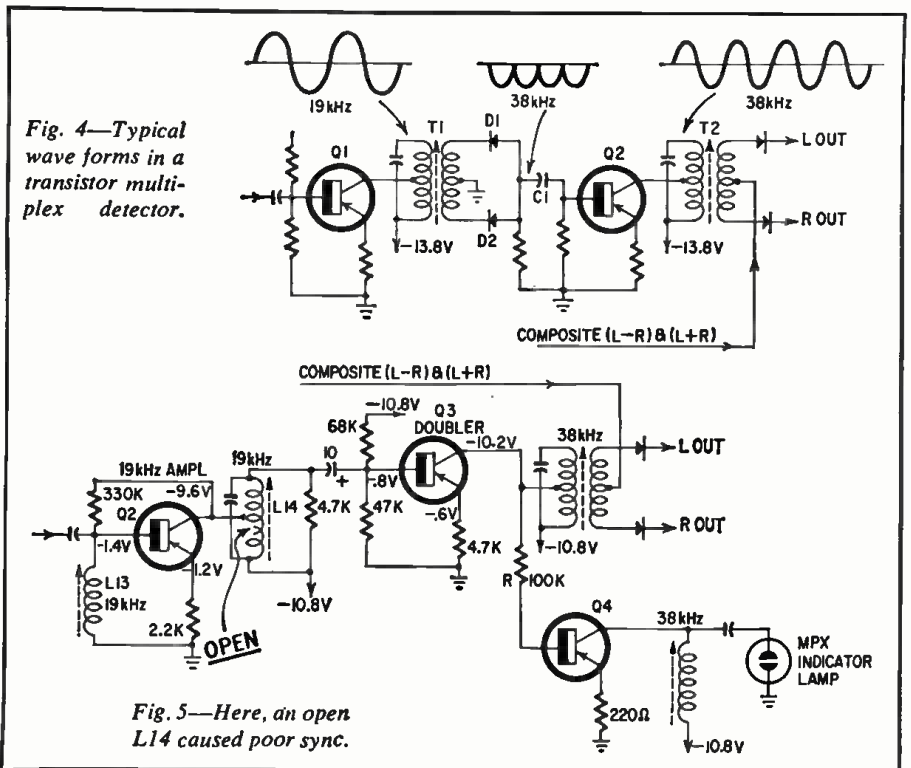

Fig. 4—Typical wave forms in a transistor multiplex detector.

Fig. 5—Here, an open L14 caused poor sync.

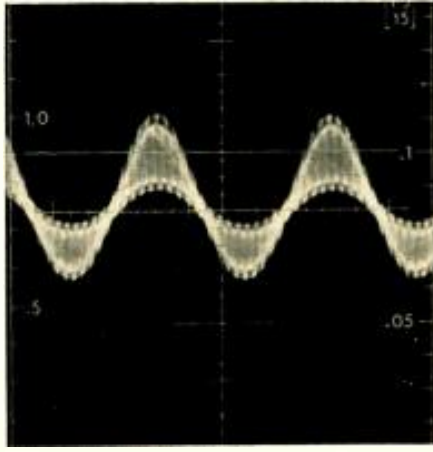
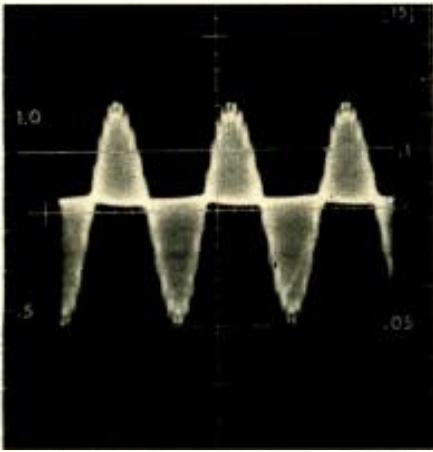

Fig. 6—Adjust FM i.f. and detector transformers to get the base line as flat as possible, as in (a-left); wavy baseline (b-right) means attenuation of L-R and loss of separation.

Symmetry of the positive and negative peaks of the waveform is more important than amplitude. Don't depend entirely on the receiver's tuning meter as an indication of best alignment. Try to get the adjustment which gives the highest meter reading consistent with symmetrical peaks.

Use full deviation from the generator, but use the rf attenuator to avoid overloading the tuner stages. Work slowly and very carefully, moving from one transformer to the next in whatever order seems to produce the best results. As with all kinds of alignment, picture-perfect results are not necessary, or even possible. In fact the waveform shown in Fig. 6-b was taken from a receiver which actually produced fairly good stereo in spite of the apparent attenuation.

The next step is to lock in the 38-kHz stage in the receiver. Switch the scope for external horizontal input and connect the horizontal-input terminal to the 38-kHz stage where it feeds the switching diodes. Put the vertical probe on the audio output from the radio detector or discriminator, and feed in the

19-kHz signal from the generator at that same point. Adjust the 38-kHz output tank for maximum horizontal deflection first, and then adjust the 19-kHz tank for a figure-8 on the screen, indicating

figure-8 without the station's audio superimposed on it.

The last step is adjusting the separation. One way to do this is to use an electronic switch connected as shown in Fig. 7.

With the scope on internal sweep and locked-in on the audio tone from the stereo generator, you should see waveforms as in Fig. 8. The right channel is on the top in both pictures. In Fig. 8-a, the "left-only" signal was supplied from the generator and the separation was not very good. Fig. 8-b shows excellent separation with the generator supplying a "right-only."

Best separation comes from touching up the 38-kHz tank with the "left-only" signal, and the 19-kHz tank with the "right-only" signal. Rock the separation control on either side of center while working with channel until you find the best overall combination which gives equal separation both ways, from left channel to right and right to left.

If your scope is calibrated and the amplitude controls of the electronic

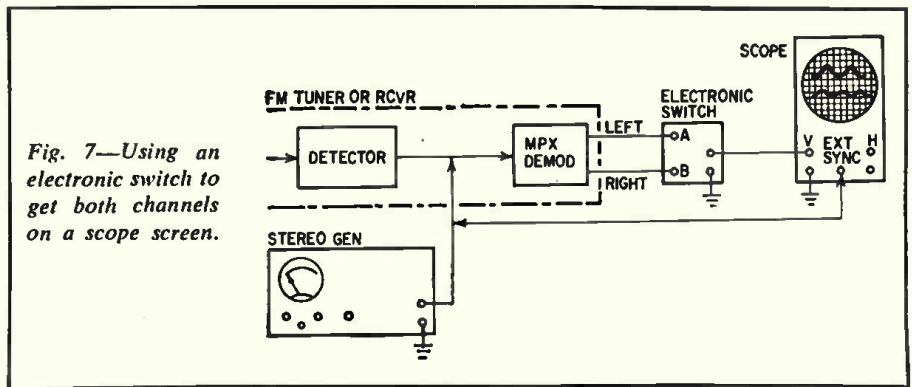

Fig. 7—Using an electronic switch to get both channels on a scope screen.

perfecting doubling with no phase shift.

You can adjust 38-kHz lock-in by listening to a stereo station instead of using the generator. Wait for a quiet moment in the programming to view the

switch in Fig. 7 are adjusted equally, you can determine the separation in dB by comparing the peak-to-peak voltages of the two signals. The separation in dB is 20 times the common log of the voltage ratio. In Fig. 8-a this is 8 dB. The practical maximum is about 30 dB.

It is interesting to watch the signals with a scope and electronic switch while listening to a stereo station. Your customers will appreciate what the stereo receiver is doing when they see this demonstration. Instead of using an electronic switch you can get similar results by connecting the right channel to the vertical input of the scope and the left channel to the horizontal input. With the scope switched to external horizontal input, the right channel will produce a vertical line and the left channel will produce a horizontal line. A musical program in stereo makes a pattern that looks like a tangled bunch of thread, pulsating continuously in time to the music.

END

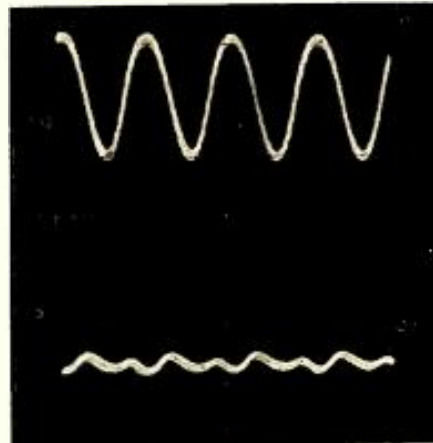
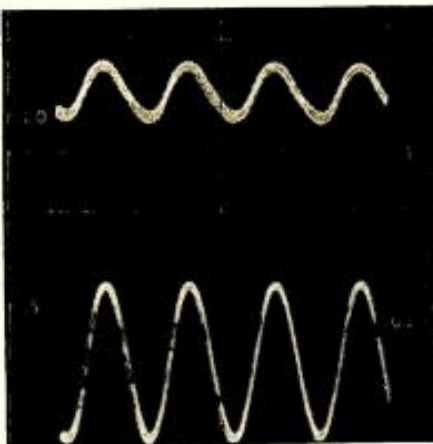

Fig. 8-a (left)—Separation was poor when left-only signal was applied. Was much better (b-right) with a right-only signal. Separation is determined by heights of two waveforms.

# Summer Fun With A Sensitive Metal-Finder

Precise search-coil locator  
you can build for \$25  
will pinpoint a gold ring  
in 4 or 5 inches of soil

By G. H. GILL



IF YOU'VE EVER TRIED TO SEARCH ELECTRONICALLY for coins or other small bits of metal on some beach or in a ghost town, you know that only the most sensitive metal finder works. Most of the circuits that have appeared are more suited for pipe-finding or tracing. To get the stability needed to find small objects, this in-

strument uses a crystal-controlled reference oscillator and a high-stability search oscillator with a Zener-regulated power supply (Fig. 1). Construction is not difficult, but you'll have to be careful and precise in aligning the oscillators.

The frequency of the crystal oscillator is not critical, but will determine

the value of inductance and capacitance in the search-coil tuning system. The values described were used with a 2,100-kHz surplus military crystal. A 160-meter amateur crystal is fine, but may require some adjustment in coil turns (explained later). The search oscillator must be tuned to half the crystal oscillator frequency to prevent the two oscillators from locking together near zero beat.

I made printed-circuit boards for the oscillators and mixer (Fig. 2), but if you prefer not to, use the drawings as a template to mark holes on a 1/16-inch plastic sheet, insert the leads and interconnect them on the other side, following the pattern of the printed circuit as closely as possible.

The search oscillator is mounted in the cutout in the search-coil support, and it must be shielded top and bottom with the nonmagnetic sheet-metal parts shown in Fig. 3.

The search coil itself is a piece of 3/8-inch copper tubing about 36 inches long, bent into a ring of 10 1/2 inches inside diameter. Make the circle as close to that size as possible, then cut the ends to leave a gap of 3/8 inch. The coil itself is eight turns of No. 24 plastic-covered hookup wire threaded through the tube. You may be able to feed it through as one continuous piece, but it is probably easier to push eight pieces through at once and then interconnect them. Doing it this way, colored wires will help. If you use four black and four red wires, for instance, and connect a black wire end always only to a red wire end, you'll avoid connecting a single wire to itself!

Mount the ring on the support with three clamps as shown in the photos. Run a ground wire from the single clamp at the end of the support opposite the oscillator back to the oscillator and ground it to the shield of the rf cable at the oscillator. Connect a .002-μF ceramic capacitor (C13) between the other two ring clamps. (The photo shows two .001-μF capacitors in parallel; the reason will be explained later.) Be sure the ends of the ring, the clamps or the capacitor leads do not touch the oscillator shields or any other ground point. Fig. 3 also shows details of the wood parts.

Run the RG-58A/U coax oscillator feed-line down through the 1/4-inch hole in the coil support (Fig. 3), up through the large cutout via the 1/4- by 1/4-inch groove in the staff, into the mixer box; ground the shield to the rotor terminal of the trimmer capacitor. Connect one end of the center conductor to the L terminal on the search oscillator board and the other end to the stator of trimmer C5. Run a jumper from here to the pad marked "C" on the mixer board.

There should be no problems in assembling the crystal oscillator and mixer circuit. You may have to drill holes in

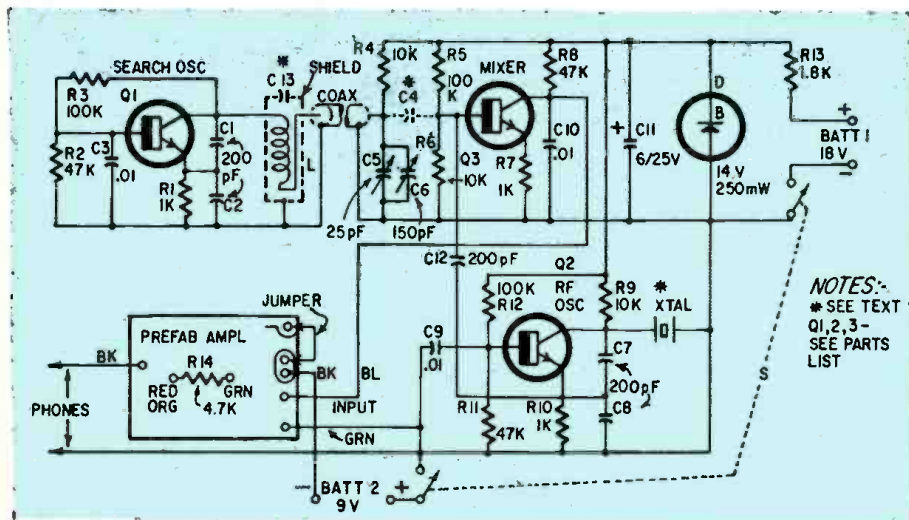

Fig. 1—Circuitry of the metal-finder. Oscillator built around Q1 is near search coil; varying frequency from it is carried by coax cable to mixer Q3, where it heterodynes with stable signal from crystal oscillator Q2. Audible beat signal goes to phones via amplifier.

- BATT 1—two 9-volt batteries in series  
BATT 2—one 9-volt transistor radio battery  
C1, C2, C7, C8, C12—200 pF, ceramic  
C3, C9, C10—.01 μF, ceramic  
C4—see text  
C5—25 pF maximum, air trimmer (Hammarlund MAPC-25B or equivalent)  
C6—150 pF maximum, mica padder (Allied stock no. 17 U 081 or equivalent)  
C11—6 μF, 25 volts, electrolytic (subminiature)  
C13—see text  
D—14-volt, 250 mW or higher-rated Zener diode, 20% tolerance (General Electric Z4-XL14) or 16-volt, 10% (International Rectifier 1N719 or 1N966-A)  
L—search coil; see text  
Q1, Q2, Q3—silicon or germanium n-p-n transistor with minimum beta of 30 alpha cut-

- off of 3 MHz or higher (Texas Instruments 2N334, RCA 2N1090, G-E 2N2926, etc.)  
R1, R7, R10—1,000 ohms  
R2, R8, R11—47,000 ohms  
R3, R5, R12—100,000 ohms  
R4, R6, R9—10,000 ohms  
R13—1,800 ohms  
R14—4,700 ohms  
All resistors 1/2 watt, 10% carbon  
S—single-pole, double-throw switch  
XTAL—quartz frequency crystal, approx 2,000 kHz (see text)  
3-transistor prefabricated amplifier (Lafayette 99 R 9039 or similar)  
Aluminum box, 5 1/4 x 3 x 2 1/8 in.  
Wood and metal parts as shown in photos  
3 ft RG-58A/U or similar coaxial cable  
Miscellaneous hardware

NOTES:-  
\* SEE TEXT  
Q1, 2, 3 -  
SEE PARTS  
LIST

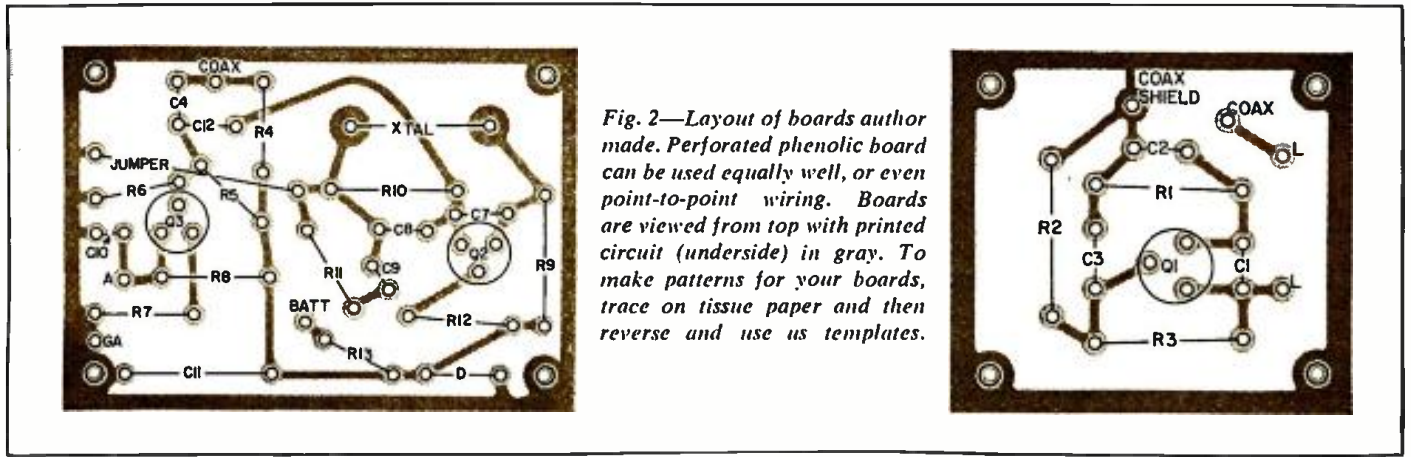

Fig. 2—Layout of boards author made. Perforated phenolic board can be used equally well, or even point-to-point wiring. Boards are viewed from top with printed circuit (underside) in gray. To make patterns for your boards, trace on tissue paper and then reverse and use as templates.

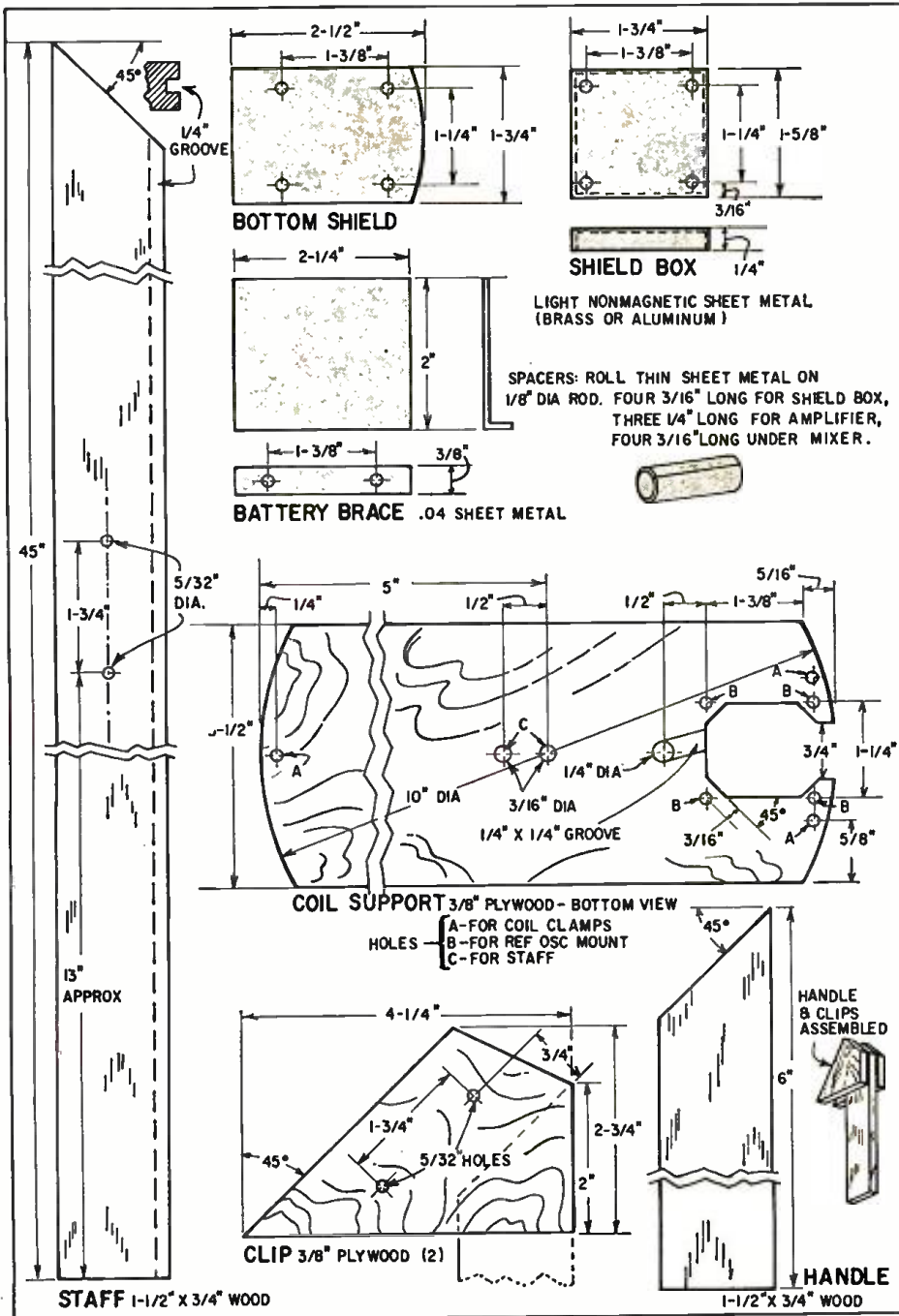
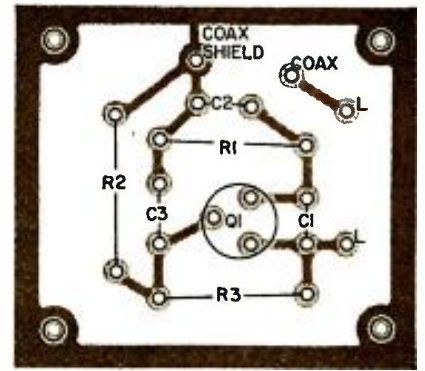

Fig. 3—The sheet-metal parts, pattern for the coil support, and the remaining wood parts.

the board to fit your particular crystal holder. Watch the polarity of the Zener diode: the cathode must be connected to the plus side of the power supply. If you use the General Electric diode, it will have to stand vertically on the board; others will lie flat.

Capacitance C4 on the schematic is only the stray capacitance between the oscillators, not an actual part. Bias is critical for some transistors used as mixers, so if the audio output is not strong enough, substitute a 1-megohm potentiometer for R5, adjust it for maximum output and replace it with a resistor equal to the measured setting of the pot.

No volume control is used in the Lafayette amplifier, so a 4.7K resistor (R14) has to be wired in its place on the underside of the board. Follow the schematic furnished with the amplifier, not the pictorial diagram; the pictorial is wrong. Connect one end of the resistor to the point where the green wire goes, the other end to the red and orange wiring points.

Two other modifications to the amplifier are needed: Remove the red battery wire from the board and connect it to one of the on-off switch terminals. Remove the orange amplifier switch lead and run a jumper from the point where it was connected to the black battery lead. Remove and discard the red amplifier switch lead.

You will have to drill a third mounting hole somewhere in the board opposite the two existing holes. There is little room, so use No. 2 screws if you can.

Mount the parts in the Minibox as shown in the photo. The positioning is not critical; in fact, some juggling may be necessary to fit everything in. Be sure the battery brace holds the batteries snugly against the side of the box so they will not rattle. Fasten the mica padder directly across the air-trimmer terminals, being sure the adjustment screw clears the box cover. Drill a large hole in the cover over the screw so it can be adjusted with the cover in place.

After all the parts are mounted, connect the oscillator battery positive terminal to the other pole of the on-off switch. Ground the other switch terminals and one phone jack to the box or ground bus of the amplifier.

Connect the amplifier input to the A terminal on the mixer, the amplifier ground to the GA terminal of the mixer, and the positive terminal of the oscillator battery to BATT. The oscillator supply is two ordinary 9-volt transistor-radio batteries in series.

Connect the amplifier battery and the phones and turn on the switch. If the amplifier is alive, connect the oscillator batteries and tune the search oscillator trimmers through their ranges. If you don't hear a beat note, check the voltage across the Zener diode. It should be 13 to 16 volts. If it is only about 2, the diode is reversed or there is a short in the circuit.

If the voltage checks out, disable the search oscillator by disconnecting one side of the coil. Feed a signal into the mixer base from a test oscillator and find the beat at half the crystal frequency. Note the test oscillator setting, reconnect the search oscillator and disable the crystal oscillator. Now find the closest beat between the search oscillator and the test set. If the search oscillator frequency is too high, but within 300 kHz of the crystal, shunt the padder in the box with a ceramic or mica capacitor as necessary.

If the oscillator is too low, but within 300 kHz, replace the .002- $\mu$ F capacitor on the search-coil clips with a larger one, or shunt it with another. (The tubing, with C13 in series, forms a "shorted" turn around the search coil. The larger C13, the lower the impedance of the shorted turn, which lowers the inductance of the search coil. Hence a larger C13 raises the search-coil oscillator frequency.) Increase the capacitance in about 500-pF steps. About .004  $\mu$ F is the upper limit; a capacitor of higher value



The search coil, tuning capacitance and their connection to the search-coil oscillator which is mounted on a small printed board.

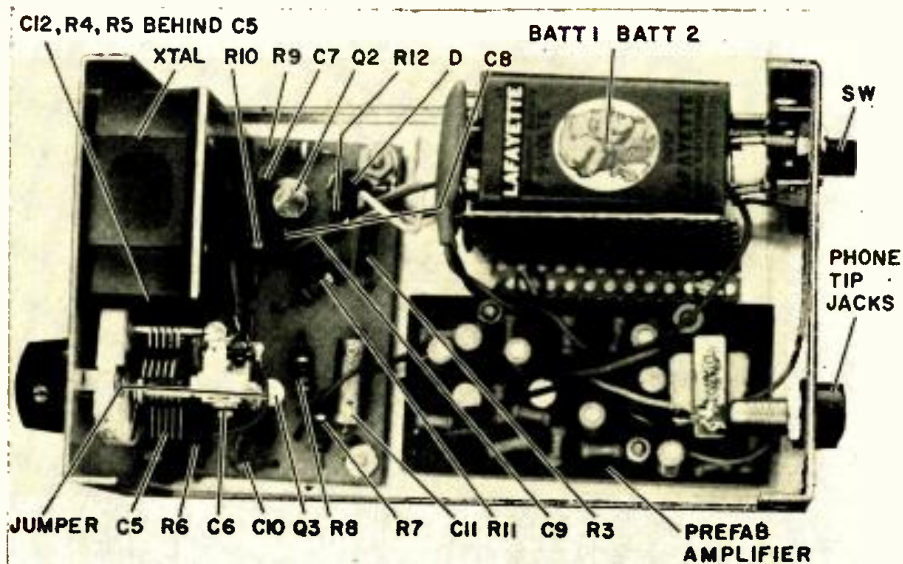

Details of the "top-end" box: crystal oscillator, mixer and audio amplifier.

is likely to stop the oscillator.

If the oscillator error is more than 300 kHz, or the adjustments are ineffective, it will be necessary to add or remove turns from the search coil. Keep C13 around .002  $\mu$ F during these adjustments.

After you get the beat note, adjust the mixer bias with R5 as necessary. Keep the mica padder tuned so that the beat is at about mid-range of the air trimmer.

A few more hints about construction: Do not fill the search ring with plastic or wax. As made, there will be some shift in frequency if the ring is bumped, but if the ring is filled, the heat of sun shining on the ring will cause a very bad frequency shift. In fact, if the unit is to be used in hot, bright sunshine, you may want to install a light plywood shield over the ring.

Paint all wood parts around the coil with a good waterproof varnish or with polyester (boat) resin to minimize water absorption.

P-n-p transistors can be used by reversing the polarity of the oscillator batteries, the Zener and the electrolytic ca-

pacitor. Don't attempt to combine the 9- and 18-volt supplies unless you want to fight motorboating!

It will take a little practice to locate small objects with the instrument. Tune the beat note to the lowest stable frequency. Sweep the search loop fairly rapidly over the area to be covered. There will be some change in frequency because of stray capacitance to the ground, particularly if C13 is a low value, but this effect is easily distinguished from the sharp change of frequency caused by a metallic object. The unit is a little more stable if the beat is tuned so a metallic object increases the frequency of the beat.

After some practice, an object the size of a dime can be detected easily 3 or 4 inches from the loop. A gold or silver ring is detectable 4 or 5 inches away. The effect depends on area more than on volume, so a piece of foil has almost as much effect as a solid object of the same area. Dry or slightly damp ground has little effect on the operation, but wet ground or salty water reduces the sensitivity.

Good hunting!

END

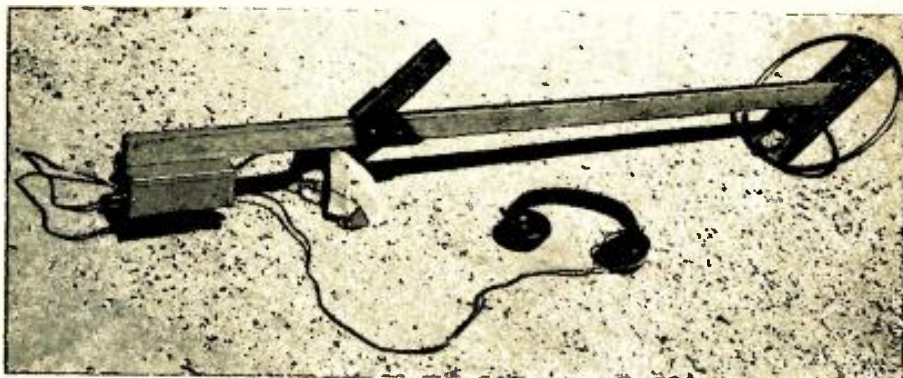

The metal-finder with its earphones, ready for a day's work.

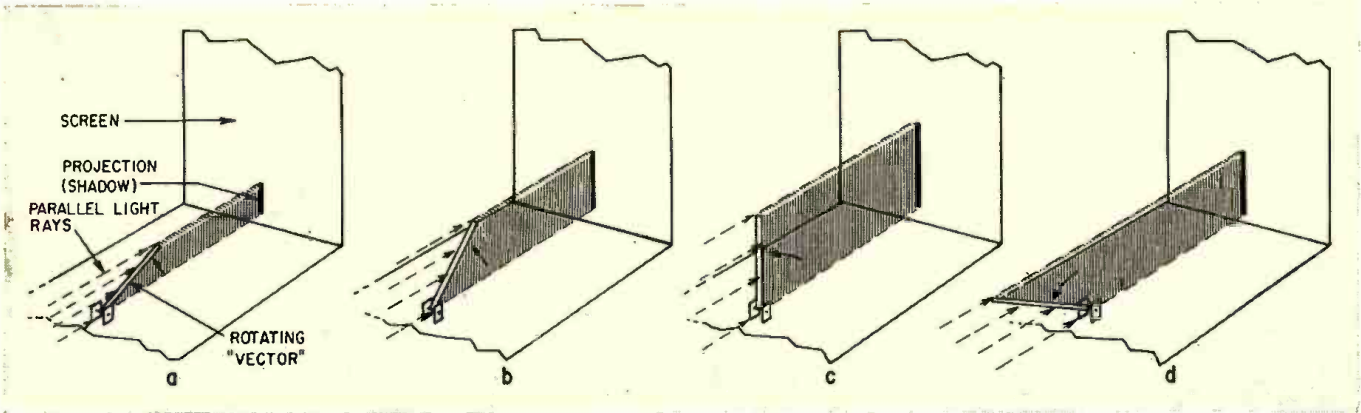

Fig. 1—Visualizing a vector projection. Vector casts varying-height shadow as screen moves horizontally in time.

## Vectors Show How Circuits Work

Everybody knows what a vector is—or do you? Maybe you weren't taught. They're helpful, though

By **NORMAN H. CROWHURST**

POWER ENGINEERS USE VECTORS EXTENSIVELY IN THEIR CIRCUIT analysis, but, in the usual treatments of electronics, vectors are hardly mentioned. Vectors can be far more useful to electronics than in the relatively simple concepts of power engineering, so limiting their use is a considerable loss.

I use vectors in my book *Mathematics for Electronic Engineers and Technicians\** as an aid in modulation analysis (amplitude, frequency and phase), in impedance analysis, in feedback circuit analysis and in multifrequency analysis, including harmonic distortion. I use vectors in analyzing the performance of different oscillator types, in active reactance (tube or transistor) design, and in the design of filters, particularly twin-T and twin- $\pi$  types. In each of these areas, vectors can shed considerable light as well as aid in actual calculations.

### What are vectors?

This whole vector business starts with the notion of a varying amplitude (voltage, current or any other quantity) being represented by the *projection of a rotating vector*. For a picture of the idea of projection, see Fig. 1.

\*Howard W. Sams/Bobbs Merrill, 1964.

A vector quantity has *direction* as well as magnitude, which is to say that it makes an angle with some reference line. A vector that represents an alternating voltage or current is constantly changing its angle as the current rises and falls with time. In other words, it is *rotating*. The projection of a vector rotating at a constant angular velocity (equal change in angle for equal time) is a sine wave, if we make the projection screen "move" in a straight line at constant speed.

As the vector rotates—we've shown it (in Fig. 2) stopped every  $30^\circ$ —the horizontal projection to each corresponding point in time along an amplitude-time graph indicates the correct point on the sine wave.

In dealing with just one simple quantity, this seems a laborious way to arrive at a sine wave. But in dealing with the many alternating currents and voltages we have to cope with in electrical or electronic circuits, a simple vector diagram can tell as much as the detailed plotting of a great many sine waves—and with far greater clarity, once you understand the vectors.

Take the relationship of voltage and current in a pure inductance (see Fig. 3) or capacitance. (Note that in all standard vector diagrams, an open arrowhead stands for voltage, while a solid one stands for a current vector. A

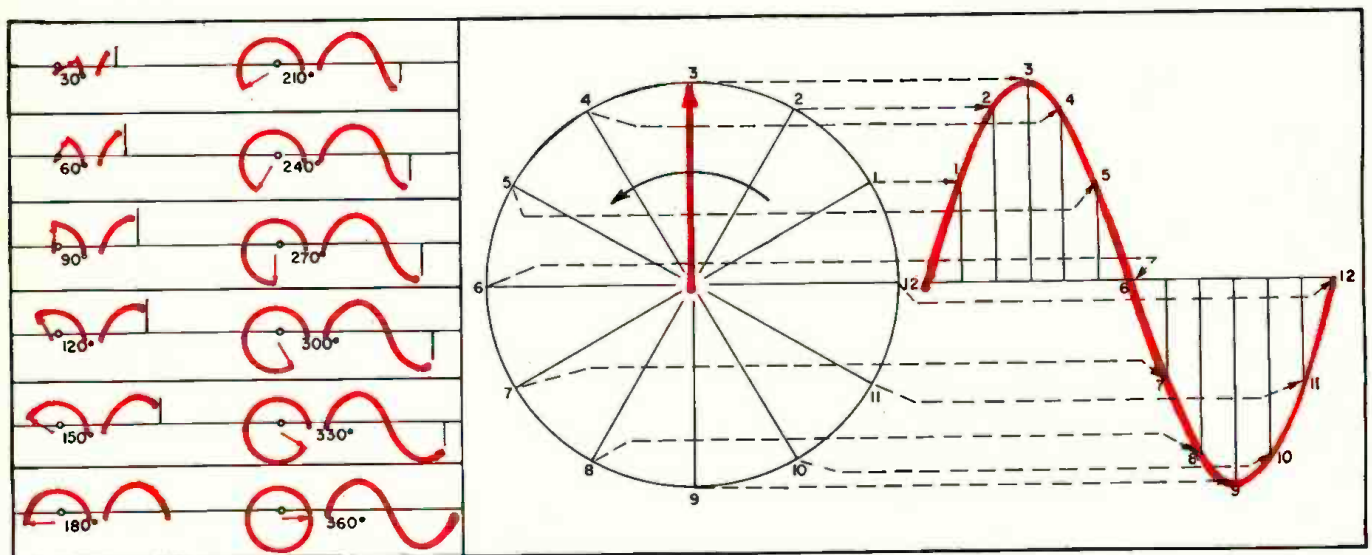

Fig. 2—Plotting out a vector; the small drawings at the left show each position through the  $360^\circ$  rotation separately. The large drawing at the right is a composite of them all.



double arrowhead represents magnetic flux.) From the principles of reactance, we know that maximum voltage occurs at the same time as zero current, and vice versa. When we put vectors at right angles and project them, we portray sine waves with the correct 90° phase displacement for inductive or capacitive reactance. We have numbered 12 corresponding points at 30° intervals of rotation (or phase), in each case.

Now we should begin to think what the vectors really mean. If we think of them as rotating counterclockwise (as is usual) their projection on a vertical axis represents the instantaneous variation of the quantities they represent. *We don't have to plot complete curves.*

In power engineering, *polyphase* diagrams take off from just that point. This is as far as most engineers have gone in their application of vectors. They may also apply them to impedances, in particular to transformer operation. A transformer contains rather a lot of circuit elements to visualize any other way (invisible ones like winding capacitance and leakage inductance). But this use is about the limit for the majority. Yet a transformer vector diagram is more complicated than some more common things in electronics, such as modulation analysis.

Before we go on, we should clear up a small point that occasionally confuses people. The conventional reference vector is often vertical, which means it coincides with a

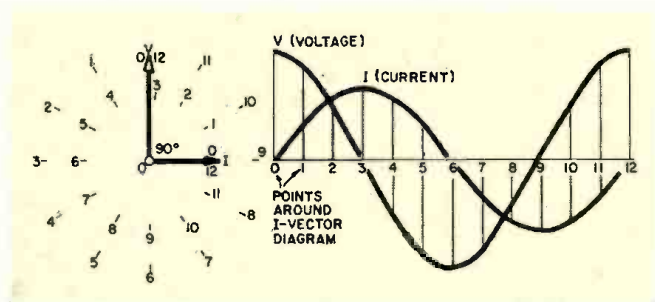

Fig. 3—A vector diagram for voltage and current in an inductive reactance. Points on sine-wave graphs are keyed with numbers to corresponding points (time) on vector diagram.

*cosine* wave. A sine wave is represented by a vector pointing horizontally to the right. This means, in conventional counterclockwise rotation, that it lags the vertical by 90°. (Notice this relationship in Fig. 3) A sine wave and a cosine wave are exactly alike in shape; they differ only by 90° in phase.

If we go into the mathematical analysis that corresponds with the vector presentation, this means the reference wave (corresponding to the vertical vector) is a cosine, rather than sine, term. If you work your vectors with trigonometrical equations for solutions, this is important. But actually *you don't need to know much trig to use this method of analysis.*

The important part of the vector concept is to be able to think of the whole group of vectors as rotating counterclockwise together. In a simple form this is shown in Fig. 3. A resonant circuit, considered at a frequency slightly above resonance, shows the same thing in more detail (Fig. 4).

In the resonant circuit, it is most convenient to start with a vector for the quantity that is common to all elements, which in the series circuit is current. Then voltage drop across the resistance in the circuit ( $V_R$ ) is in phase with current. The drop across the capacitance ( $V_C$ ) falls behind (lags) that by 90°, and the drop in the inductance ( $V_L$ ) runs ahead (leads) by 90°. In this diagram, the inductive voltage is a little bigger than the capacitive, so the resultant is the difference between these two, added vectorially to the resistance component by taking the diagonal of the rectangle, or "completing the parallelogram."

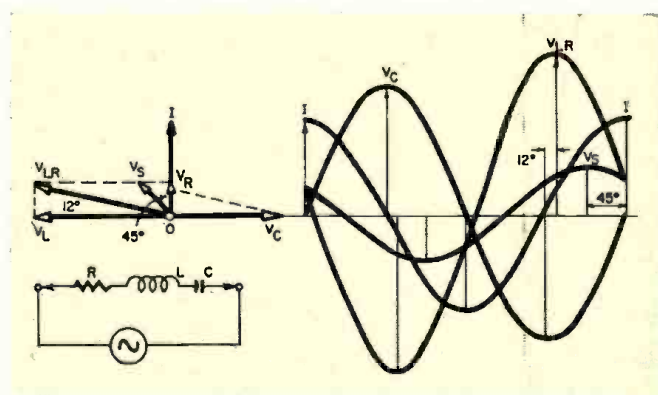

Fig. 4—Vector diagram and waveform analysis for series-resonant circuit, at a frequency slightly above resonance.

Normally R is physically part of the inductor so, while the vector diagram at Fig. 4 breaks the voltage across the inductor into its resistive and reactive parts, the completed parallelogram uses components that are measurable—the voltage across the composite inductor being  $V_{L,R}$ . This is also used in curve development, which shows the relationship between angles on the vector diagram and the maximum points (on the curves) that represent the vectors.

If you're not sure this works, you should check out the procedure called completing the parallelogram (Fig. 5). The construction is simple enough: you just draw parallels and then fill in the diagonal. You can check that it works by projecting the sine waves from each vector. You will find that, at each point, the diagonal vector projects an instantaneous magnitude that is the sum of the instantaneous magnitudes of the two vectors that make it up.

We've plotted points at each 15° interval through the full rotation of 360°. Note that the magnitudes of the waves agree with the lengths of the vectors correspondingly lettered, and that geometrical angles A, B and C correspond with the phase angles between similar points along the curves marked A, B and C.

You must grasp the notion that a whole vector diagram, with all its vectors, rotates counterclockwise en masse. The operating frequency of the circuit elements sets the frequency of rotation. Once you learn that, plus this easy method of vectorial addition by simple geometry, you're ready to move on to more exciting things.

In the months to come, we hope to show you how you can apply your new understanding of vectors to clear up some of the more puzzling concepts of electronics. Watch for a vector analysis of phase modulation next. END

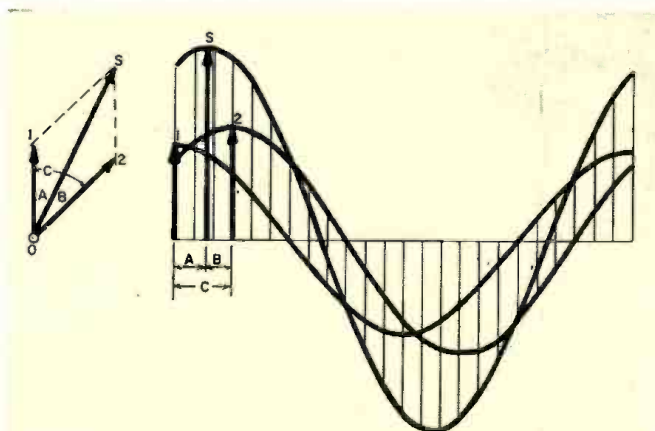

Fig. 5—Vector addition works! Vectors 1 and 2 add to make resultant (diagonal of parallelogram), or vector sum, S.

# Restoring Middle-Aged CTC's

With color TV booming, people with sets 5 years old are wondering whether to trade for a new one or overhaul the old. You can help them!

By JACK DARR

WE'VE HAD "MIDDLE-AGED" BLACK-AND-white TV sets with us for a long time: good makes about 5 years old with normal deterioration. About that time, the owner begins to think "trade or overhaul?" In most cases, a full overhaul job will put the set in new condition for far less than the cost of trading. I don't mean one of the "just get it to light up" service jobs, but a real, professional overhaul. Now, owners are faced with the same dilemma with color sets. So, let's see what this kind of a job will take.

Between 1957 and 1962, nearly all color sets used RCA chassis. No matter what it said on the front, inside was a chassis between a CTC7 and a CTC12. Although there are slight differences, they are close enough so that we can use the same methods on all of them.

Total cost is the main thing, of course. Unless we can put the set into first-class shape for less than the cost of trading, we're not going to get very far. So, we check all the big things first, and of course the biggest thing is the tube. A color tube lasts a long time, but it'll have to be checked very carefully, so that we can get a realistic estimate of how much life it has left.

If the tube's pretty far gone, and the set has a big, beautiful cabinet, as so many have, we can replace it with one of the rare-earth or sulfide types, and really make a great improvement in performance. If it's a maybe-thing, and the old tube is marginal, explain it to the owner and let him make the decision.

## Cost differences

From what I can find out (and these are only rough-average figures, of course), a new color set will be about \$500. Trade-in allowances run from \$100 for old sets to about \$250 for later models. So, this leaves from \$250 to \$400 difference to be paid.

A new 21FBP22 CRT lists for \$130 (at this writing). Even with a new tube, the overhaul job can give the owner a practically new set for just about half the cost of trading it in. Other parts needed will vary widely, so there's no way of telling just what each job will run. So, watch out for hard and fast estimates, make a very careful preliminary check of the set, to get the best possible idea of its condition, before you outstick the neck.

This is not a *service* job, but an *overhaul*: that means a complete check of the set from one end to the other. It's a good idea to make up a check list, like the one on the next page, to be sure you cover everything. (Giving a carbon copy of the list to the owner wouldn't be a bad idea, either.) Actually, it takes a surprisingly short time to run a complete check of even a color chassis, if you have full service data on it—and you'd better have.

## Service methods

The first thing to do, when you get the set to the shop, is give it a close "eye-ball test." Look for obvious things like discolored resistors, salting around electrolytics, shaggy wiring, and, above all, for signs of sloppy servicing in the past. *There will be some kind of trouble* (or

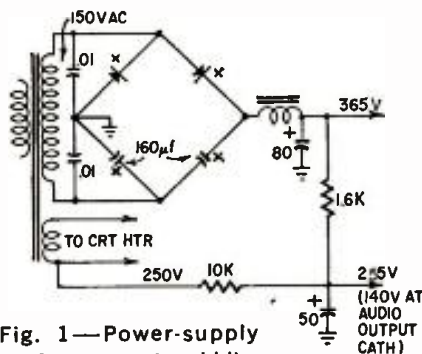

Fig. 1—Power-supply configurations in middle-aged RCA CTC color chassis. These cover the CTC7AA, CTC9, CTC10, -11 and -12. There are several variations of this supply.

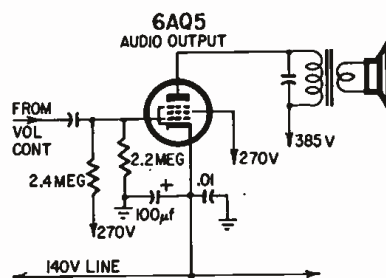

Fig. 2—This partial schematic shows the stacked-B-plus supply scheme used in the CTC7, -7AA and -9. The audio output tube acts as a series dropping resistor for the dc fed to other stages (along the 140-volt line). Grid resistor values are critical, because changes in bias will affect audio tube's resistance, and hence will affect the voltage coupled to the other stages.

you wouldn't have been called in the first place), so find it, fix it, and then you can tell where you are. Now, the fun starts.

Give it an *operation test*, and really lean on it! Be critical! Look for marginal operation of *all* circuits: smeary pictures, noisy controls, poor sync, noisy tuner—everything.

Now, check *all* tubes. The purpose of this, and of all following steps, is to catch the troubles that would otherwise turn up in the first week after you take the set back. Watch for tubes with grid emission, gas and small leakages. Replace any tubes that show less than normal output, and *check the new tubes* before you put 'em in, just for luck.

Check *all* operating voltages. Doesn't take as long as you might think. If the plate voltage is off in any stage, find out why. Check grid and cathode voltages very closely, for they'll often point to troubles coming up in the future, like leaky coupling capacitors, drifted bias resistors, and such like. Remember, while making this test, that all voltages shown on schematics are read with no signal input. This makes a big difference in such stages as agc, i.f.'s, sync, etc.

Check voltages in the video output and color amplifier stages. With the dc coupling to the CRT, these voltages can affect the color temperature of the screen and cause drift. In early sets, we had lots of trouble from drift in plate resistors due to overheating; watch for it.

## The most likely troubles

Strictly from "statistical probability" (meaning, these are the circuits where we can always expect trouble!) check the power supply very carefully. If it is off, the whole set's off. Fig. 1 shows the circuits used. Voltage doublers in all of them except the CTC7, which has two 5U4 tubes. The output voltages are about the same. Check both halves of doubler circuits to be sure they balance. Unbalance here indicates a weakening rectifier or a doubler capacitor that's on the way out.

The CTC7, CTC7AA and CTC9 use a stacked-B circuit in the audio output to get their 140-volt supply. The rest get this voltage from a tap on the voltage divider. In CTC10's only, there is a 22-volt tap; this feeds the agc tube cathode through a 7,500-ohm control.

Disconnect the main B+ line and read the total current drain. This is given on the schematic, and it's a very good way to find out if anything is wrong in heavy-current stages like the horizontal output, vertical output, etc. Check the cathode current of the horizontal output tube and high-voltage regulator, and run a full setup procedure on the regulator to make sure that it's

*continued on page 64*

# Cut the time BETWEEN NOW

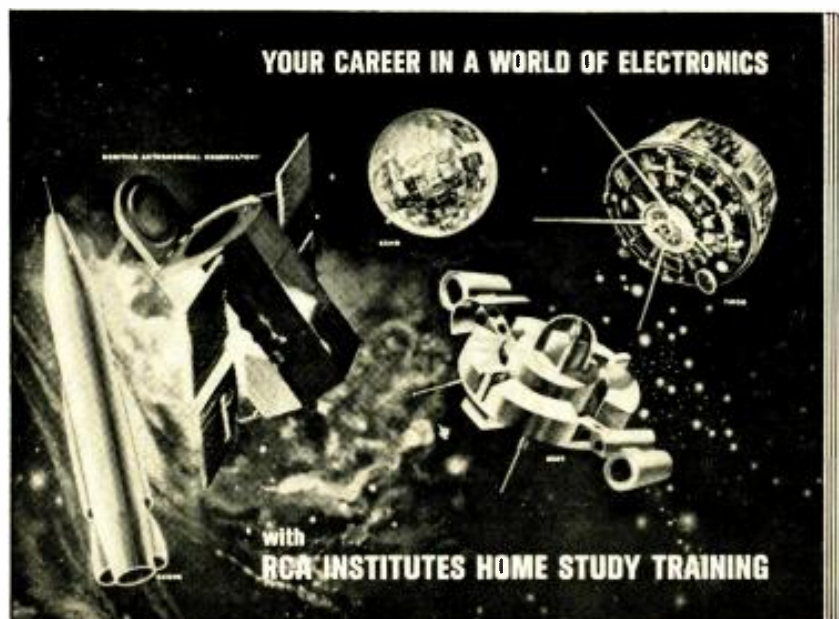

# AND SUCCESS

**SEND CARD FOR RCA'S NEW 1966  
HOME STUDY CAREER BOOK TODAY**

- Find out about RCA Institutes Career Programs.
- Learn about the amazing "Autotext" programmed instruction method—the easier way to learn.
- Get the facts about the prime quality kits you get at no extra cost.
- Read about RCA Institutes' Liberal Tuition Plan—the most economical way for you to learn electronics now.
- Discover how RCA Institutes Home Training has helped its students enter profitable electronic careers.

Lots more helpful and interesting facts too! Send postage-paid card for your FREE copy now. No obligation. No salesman will call.

**RCA INSTITUTES, Inc.** Dept. ZRE-76  
350 West 4th Street, New York, N. Y. 10014

RCA Institutes also offers  
Classroom Training.  
Catalog free on request.  
(Courses also available in Spanish)



**The Most Trusted Name in Electronics**

Circle 28 on reader's service card

# NEW SAMS BOOKS

## ABC's of Citizens Band Radio

NEW SECOND EDITION



by Len Buckwalter. Latest guide to planning and setting up an efficient CB two-way radio system. Explains functions, principles of operation, regulations, and setup and operating procedures. Completely updated to include latest changes in rules and regulations; describes recent improvements in CB equipment. Explains the origin and development of CB radio, and how you can become active in this important field, how to obtain your FCC license, and how to efficiently set up and operate your own CB radio system. 128 pages; 5½ x 8½". \$225  
Order ACR-2, only.....

## Solving TV Tough-Dogs—New 2nd Edition

by Robert G. Middleton. Tough-dog problems in TV servicing are a time-consuming headache. This newly revised and enlarged book helps you quickly select the right approach, pinpoints the trouble source, and saves valuable time. Presents the best techniques proved practically in the field, and shows you how to avoid pitfalls. Includes new information on servicing color TV, and on all-transistor TV portables (notorious for tough-dog problems). Describes simple diagnostic aids. \$325  
160 pages; 5½ x 8½". Order TDM-2, only.....

## Small Engines Service Manual—Eighth Edition

INVALUABLE FOR SERVICING SMALL ENGINES!

This popular and practical manual provides all the know-how you need to service virtually any small engine in operation today. Enables you to repair all popular engines used in lawn mowers, garden tractors, karts, scooters, tillers, etc. Special section explains operating principles; includes instructions for track tuning of kart engines. Provides detailed service coverage for over 1,300 models in 25 popular domestic and foreign makes. 320 pages; 8½x11". Order SES-3, only. \$495

## ABC's of Boolean Algebra—New 2nd Edition

by Allan Lytel. Provides a clear understanding of the symbolic logic used in all digital systems—the basis of modern automation, telephone systems, electronic computers, and process controls. Simple block diagrams show the relationship between language and switches, the principles of logical design, and examples of the application of these principles. Covers switching circuits in terms of simple toggle switches and relay circuits with various modifications. 112 pages; 5½ x 8½". \$225  
Order BAB-2, only.....

## TV Tube Symptoms & Troubles—New 2nd Edition

by Robert G. Middleton. Most TV troubles are caused by faulty tubes; the trouble displayed on the picture tube can be quickly traced to the tube responsible, and repair can be made in minutes. Middleton first examines what each section of a TV set is supposed to do, and what happens when it doesn't. Many photos of actual TV trouble symptoms help to identify which tubes are at fault (symptoms are indexed for quick identification of types of trouble). A handy "tube trouble" chart lists the most common troubles and the specific tubes which cause them. 96 pages; 5½ x 8½". Order TVT-2, only..... \$195

## FM Multiplexing for Stereo—New 2nd Edition

by Leonard Feldman. The most up-to-date book available on this new broadcasting technique. Describes all new stereo receiver and adapter designs; thoroughly explains the inherent problems, and alignment procedures for proper stereo recovery and reproduction. Provides a clear understanding of the composite stereo signal and how FM stereo broadcasting works. A valuable book for technicians and audiophiles. 176 pages; 5½ x 8½". Order FMS-2, only..... \$325

## HOWARD W. SAMS & CO., INC.

Order from your Sams Distributor today, or mail to Howard W. Sams & Co., Inc., Dept. RE-7  
4300 W. 62nd Street, Indianapolis, Ind. 46206

Send me the following books:

- ACR-2    SES-3    TVT-2  
 TDM-2    BAB-2    FMS-2

Send FREE Sams Booklist. \$\_\_\_\_\_enclosed

Name \_\_\_\_\_

Address \_\_\_\_\_

City \_\_\_\_\_ State \_\_\_\_\_ Zip \_\_\_\_\_

My Distributor is \_\_\_\_\_

Circle 29 on reader's service card

working as it should.

Measure the boost voltage; it is a very good indicator of the overall condition of the HV circuits and sweep. Voltages run from 820 in CTC7's to 640 in CTC10's. Check settings of the horizontal efficiency coil, to be sure that the horizontal output tube is working within safe current limits.

Above all, make a scope check of the B+ ripple voltage. Normal ripple runs from .07 volt p-p on the CTC7 up to 1-3 volts p-p on the rest. If you see more than this, find out which filter capacitor is going bad and replace it. Check all B+ lines for clean filtering of horizontal and vertical pulses and spikes.

### Resistor drift

There are three circuits where you are going to have to watch out for resistor drift. The agc and vertical oscillator circuits have lots of high-value resistors. These are critical. They're all part of voltage-divider networks, so you'll have to open the circuit somewhere to measure them without running into meter shunting effects.

The big ones, up to several megohms, have a nasty habit of drifting in value. Replace any that are more than 5% off, and watch out for "thermals", especially in the vertical oscillator grid circuits!

In the grid circuit of the stacked audio circuits of the first three models, check the grid resistors. They form a voltage divider across the B+, and determine the bias on the audio output tube, which in turn sets the level of the 140-volt line. If these resistors drift, off goes your bias, off goes the 140-volt line.

### Alignment

I don't think you'll find too many sets out of alignment, barring cases of screwdriver drift. If a set needs alignment, give it a full sweep alignment, for this is the only way to get the correct results in a color chassis. Watch out for trap settings, especially the adjacent-sound traps at the i.f. input. If these are set too near the sound carrier, they'll cause a response curve droop at that end, and away goes your color; you'll have tricky fine-tuning on color, color dropouts, and beats in colored objects. Be sure to use the proper override bias while aligning, as given in the alignment instructions.

### Final checks

After it's all checked out, slip the chassis back into the cabinet and give it a thorough cookout test. Run a full setup procedure: color temperature, tracking, purity and convergence. Watch out for things like a deflection yoke or convergence yoke that has been knocked out of position, or a blue lateral magnet that isn't where it ought

to be. These will foul up your edge convergence badly.

## COLOR TV OVERHAUL CHECKLIST

- 1. Test all tubes, including CRT.
- 2. Measure all operating voltages, especially grid and cathode voltages.
- 3. Check picture, sound, sync and color.
- 4. Check waveforms, especially ripple on B-plus and all feedlines.
- 5. Check all controls for quiet operation; clean or replace.
- 6. Clean tuner.
- 7. Check purity, tracking and convergence.
- 8. Cook out thoroughly.

Cook it for a long time. It would be best to take about 2 days. Make at least two long runs, of 4 hours or more, to show up any thermal drifting, change in color temp, etc. That's why you put it back into the cabinet, so that it'll run at its normal operating temperature. Unless you are an incurable optimist, don't put the bolts back in yet, though!

Make several "cold starts" on it, to be sure that it comes on in sync, to check for tuner drift, and things like that.

### Warranty

For the final touch, give the owner a 90-day warranty on all the parts that you have replaced, and perhaps a "free checkup" service call. This is good psychology, and you'll probably average about one service call per job anyhow. (Allow for this call when figuring the cost on the job.) It may be a nuisance call, or one of the tubes may quit, but you can't tell, so make allowance for this.

As an average, a job like this should run about 8 hours bench time, and should be charged for accordingly. Depends entirely on the condition of the set, of course.

Watch the little details! You'll find things like this, from real life: "I don't believe he did a thing to that set! This knob was loose when he took it away, and it's still loose! He's a gyp!" Moral, of course—watch for loose knobs! END

# EQUIPMENT REPORT

## Heathkit AR-14 All-Transistor FM-Stereo Receiver

Circle 26 on reader's service card

THIS NEW HEATHKIT FM STEREO RECEIVER is a remarkable piece of design. At a price of \$99.95 in kit form, it combines just about every desirable feature—including excellent performance—for a small home-music system. The amplifier portion is frankly low-powered, but the specs at its continuous power of 10 watts per channel match those of many higher powered amplifiers at their maximum outputs. Using it with low-efficiency acoustic suspension speakers



will strain it somewhat, although it did nicely with a pair of AR-4's. It'll be best with bookshelf systems of the ducted-port bass-reflex type.

The AR-14 is an all-transistor circuit, with an rf amplifier, separate mixer and oscillator, four i.f. stages and a balanced ratio detector. Despite the frequently mentioned problem of cross-modulation in transistor FM front ends, this receiver acquitted itself completely under what might be called normal listening conditions in a metropolitan area. There was no trace of spurious responses when the receiver was used with an indoor antenna—even an amplified antenna (with built-in transistor booster). A few experiments suggested that cross-modulation would be a problem in a city such as New York with a large number of nearby FM transmitters, but only

if the listener uses the receiver with a rooftop antenna.

Stereo separation is adjustable for optimum with the help of a unique PHASE control. This control adjusts the phase of the locally reinserted 38-kHz multiplex subcarrier. As you know, stereo separation depends entirely on the phase relationship between the subcarrier and its sidebands, and the main carrier modulation. On the AR-14, you need only to pull out the PHASE control knob and turn it for maximum loudness, then push it back in.

Pulling out the knob actuates a switch which throws a 38-kHz bandpass filter into the audio line to the multiplex

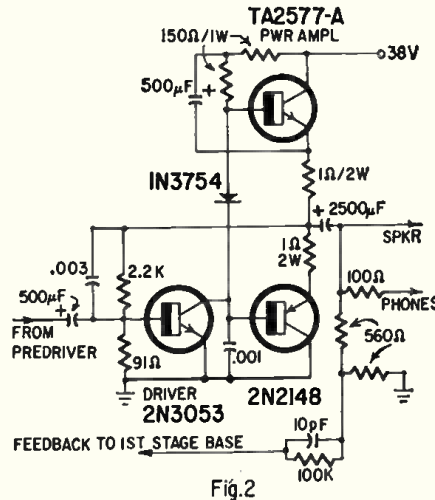

Fig. 2

detector. See Fig. 1. Only the 38-kHz subcarrier AM sidebands can pass; the monophonic L+R signal is filtered out. The phase control can then be adjusted for maximum loudness of the subchannel—something that would be impossible with the main channel booming in. Another useful feature of the switch (without the use of the PHASE control) is that you can determine what multipath reception is doing to your sound. It often causes a vague distortion that's hard to pin down. If you pull out the PHASE control, you no longer have the masking effect of the main channel (which is less

susceptible to being messed up), and you can orient your antenna for minimum subchannel (L-R) distortion. This circuit trick also reduces the fussiness of multiplex detector alignment.

The AR-14 uses a very simple complementary-symmetry output circuit for each channel (Fig. 2). It works beauti-

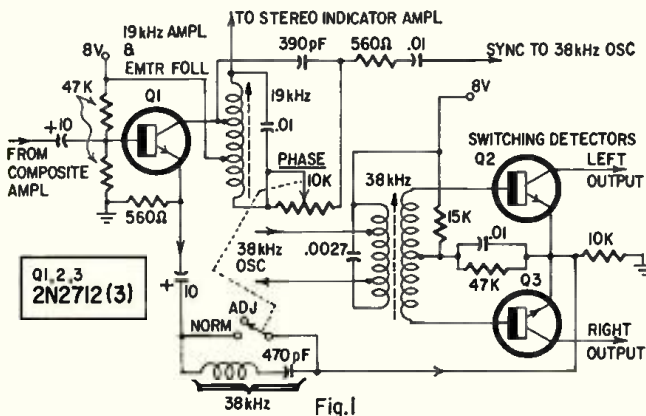

Fig. 1

### COMPLETE TUNER OVERHAUL

# 995

**ALL LABOR AND PARTS**  
(EXCEPT TUBES & TRANSISTORS)\*

### COLOR TUNERS

GUARANTEED COLOR ALIGNMENT - NO ADDITIONAL CHARGE

Simply send us the defective tuner complete; include tubes, shield cover and any damaged parts with model number and complaint. Your tuner will be expertly overhauled and returned promptly, performance restored, aligned to original standards and warranted for 90 days. UV combination tuner must be single chassis type; dismantle tandem UHF and VHF tuners and send in the defective unit only. Exact Replacements are available for tuners unfit for overhaul. As low as \$12.95 exchange. (Replacements are new or rebuilt.) And remember—for over a decade Castle has been the leader in this specialized field... your assurance of the best in TV tuner overhauling.

## CASTLE

TV TUNER SERVICE, INC.

5715 N. Western Ave., Chicago 45, Illinois  
41-96 Vernon Blvd., Long Island City 1, N. Y.

For service in Canada write to Chicago or use reader service card in this magazine.  
\*Major parts are charged extra in Canada.

Circle 30 on reader's service card

## FINCO-AXIAL COLOR-KIT

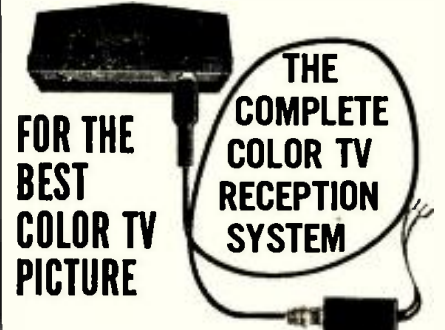

FOR THE BEST COLOR TV PICTURE

VHF • UHF • FM • PASSES AC & DC eliminates color-fade, ghosting and smearing! Improves FM and Stereo, too!

**FINCO-AXIAL COLOR-KIT, Model 7512 AB**  
High performance Indoor and Outdoor Matching Transformers convert old-fashioned and inefficient 300 ohm hook-ups to the new Finco-Axial 75 ohm color reception system. List price for complete kit 7512 AB ..... \$8.95  
7512-A Mast mounted matching transformer, list \$5.40  
7512-B TV set mounted matching transformer list \$4.15

**FINCO-AXIAL SHIELDED COLOR CABLE, CX Series**  
Highest quality, 75 ohm swept co-axial cable (RG 59/U) complete with Type F fittings and weather boot ready for installation.

Available in 25, 50, 75 and 100 foot lengths. List price... \$5.55, \$8.65, \$11.50 and \$14.20  
Write for Color Brochure Number 20-349

**THE FINNEY COMPANY**  
34 West Interstate St., Dept. RE Bedford, Ohio

Circle 31 on reader's service card

fully; the transistors run cool and the circuit is not immediately damaged by accidental shorts. (Prolonged shorts will kill one or both transistors, however.)

The remainder of the audio system is fairly conventional, except that, to simplify switching, all audio sources—phono, FM and auxiliary—are sent through the preamp, which is RIAA-equalized or flat, automatically, as required by the input selected. The high-level sources (tuner and auxiliary) are preattenuated with resistive dividers before reaching the preamp. This gives tuner and auxiliary inputs a somewhat poorer signal-to-noise ratio than they would normally have by bypassing the preamp. Hum and hiss are noticeable, and might be disturbing to the audiophile accustomed to quieter equipment, but they are not too annoying except during critical listening to quiet musical passages.

The power supply is quite husky, and there is only about 1 watt or so difference between the power available from each channel for 1% distortion with both channels driven and with only one driven.

Tone controls are the very desirable Baxandall feedback type, ganged so that one knob controls both channels. The volume control is a dual concentric type, with the two knobs normally friction-locked together. One can be held while the other is turned, to balance the channels, but this shouldn't be necessary unless dissimilar speakers are used. There is no separate balance control.

The AR-14 also has tape-recording outputs, unaffected by tone and volume settings, with an output impedance of about 3,500 ohms. This is low enough to allow some 20 to 25 feet of shielded cable between receiver and recorder.

Permanent, nondefeatable afc is used in the AR-14, which might annoy some. Few of the better tuners have afc nowadays, and the "feel" of it might be disturbing to some users. As you tune toward a station, the afc grabs hold and the station is instantly centered in the receiver's passband. Once you get used to it, it's very convenient, especially for users who don't care about the niceties of precise tuning and just want their station with a minimum of fuss. Heath was wise, I think, in including it, although it causes the tuner to skip right over a weak station if there is a strong one near it in frequency. (The afc can be defeated by grounding the point marked "X" in the front-end circuit—see the schematic that comes in the kit manual.)

The kit is not difficult to build, but it does take a good deal of time. Most of the wiring is on two large printed-circuit boards. The front-end, mercifully, is already wired and aligned, and the various other coils and transformers are set close enough to the proper frequency so that you can expect the set to work the first

time you turn it on. The hardest part of the assembly was stringing the dial cord, but that's no news to anyone who's strung dial cords.

The manual is one of the most comprehensive I have ever seen. It's like getting a free course in FM stereo with your kit. The book also contains complete (and I mean *complete*) alignment and troubleshooting instructions, with voltage and resistance charts, circuit-board layout patterns, and an unusually complete list of performance specifications, with curves. Fine job.

Altogether, the Heath AR-14 is an excellent buy, compact, light, sturdy, and ideal for a low-cost small-apartment system, or as a second system for people with a more elaborate installation.

—Peter E. Sutheim

Price: \$99.95

## B & K 1245 Color Generator

Circle 27 on reader's service card

THE IDEAL ELECTRONIC APPARATUS IS A "black box" with only two terminals, from which we can get anything we want. B & K ruined my joke by making the model 1245 Color Generator a dark gray, but it's about as close as you can get, otherwise. Eight inches long and deep, and only three inches high, it's almost a pocket-size source of all signals you need for setting up and servicing color TV's.



Only two controls are used: a PATTERN selector switch and a COLOR AMPLITUDE control, which is also the on-off. (More on this later.) A gun-killer circuit is provided, with insulation-piercing clips. No adapter needed. The circuit is all-transistor and crystal-controlled. Sixteen transistors and 13 diodes are used, five of the transistors being unijunctions.

A crystal-controlled Clapp oscillator provides a 189-kHz signal with three separate outputs. A differentiated square wave syncs the 31.5-kHz oscillator, a square wave keys the colors, and a pulse-shaper generates vertical lines. The divider chain uses 31.5 kHz, 4.5 kHz, 900, 300 and 60 Hz. Horizontal sync is taken from the 31.5 kHz circuit; since this is only a "divide-by-two" step-down, it is very stable and needs no adjustable control.

Five unijunction transistors are used in the divider chain as relaxation oscillators. While these are called transistors, their action is more like thyatrons,

or SCR's. Sync from the preceding stage is fed to the base-2 connection, and when this reaches the proper level, the base-emitter junction fires very rapidly, and conducts heavily. This gives a very steep rise-time on the output pulses, and a very good sync action for the following stages.

A computer circuit is used in the 450-Hz flip-flop to trigger the horizontal lines. It looks like a multivibrator, but which is triggered into conduction only by pulses instead of running free. One transistor is on and one is off at any time. Triggering this by a 15,750-Hz signal starts the horizontal-line signal, and the next 15,750-Hz pulse cuts it off. So all horizontal lines are exactly one scanning-line wide on the CRT. This gives the finest possible lines for cross hatch and horizontal-line convergence patterns.

Vertical-line pulses are generated by a radar-type pulse generator, or "multi-R" circuit. Output is a very narrow, fast pulse, its width determined by the R-L characteristics of the circuit, and not by the transistor parameters. With this, no dot-width adjustment is necessary. However, the *amplitude* of these pulses can be varied by a control ganged with the color control. It works only when the pattern selector is in DOT, CROSSHATCH, or HORIZONTAL positions.

The instruction book with this instrument is very well written. It offers plain explanations of each circuit and full instructions for using and, if need be, servicing the generator. A novel method of setting the dividers is given: it actually makes Lissajous figures on even a narrow-band scope. For example, the 60-Hz stage is set up by feeding the 60-Hz signal into the horizontal input of the scope, and the preceding stage's output (300 Hz) is fed to the vertical input. All you have to do is adjust for a 5-loop Lissajous figure, and you're set up. Of course, this setup procedure must start at the high-frequency (oscillator) end of the chain and work down (toward a lower frequency), but all connecting points are very plainly shown on a layout and on the schematic. Seven loops is the most you'll have to count, so this is a very easy method.

Both sync pulses in this instrument have accurately shaped porches, so that the output is practically a duplicate of the TV station signal, and gives very good sync action in the TV circuits, even to blanking pulses for both horizontal and vertical circuits. In field tests, the stability was excellent.

Color circuits are the by-now-standard keyed-rainbow type, with a total of 10 bars, and brightness signals "behind" each bar to check color fit, delay-line action and such. The bars are 30° apart, which is becoming standard.

—Jack Darr

Price: \$134.95

END

# NEW SEMICONDUCTORS, MICROCIRCUITS & TUBES

## FET's and IC's FOR EXPERIMENTERS

Motorola Semiconductor's "HEP" (Hobbyist, Experimenter, Professional) program of consumer-oriented electronics is expanding to include field-effect transistors and integrated circuits.

One FET is called the HEP 801 and is designed for low-power switching and amplification in the audio range. It costs \$3.39 and should be available through local Motorola distributors by the time this magazine reaches you.

Five integrated circuits will enter the HEP line: an R-S flip-flop (HEP 552), a half-adder (HEP 553), a bias driver (HEP 554), a gate (HEP 556) and a J-K flip-flop (HEP 558). One-at-a-time prices range from \$1.69 for the bias driver to \$5.99 for the J-K flip-flop.

Information on these devices is available from Motorola Semiconductor Products, Inc., P.O. Box 955, Phoenix, Ariz. 85001.

## LOW-CROSSMODULATION FET

A new metal-oxide/semiconductor (MOS) field-effect transistor from Fairchild is billed as having low noise and low crossmodulation. Field-effect transistors have been gaining attention recently as engineers discover they are often better than tubes in that respect.

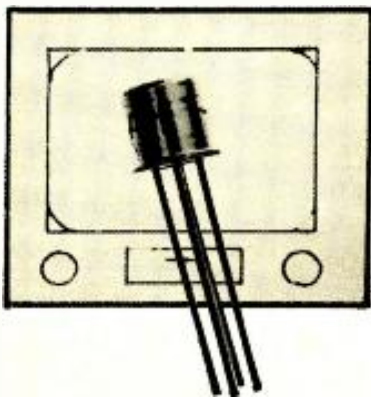

(Ordinary transistors produce severe crossmodulation even at comparatively moderate signal levels in radio receivers. One effect of crossmodulation is to make a signal appear at several harmonically unrelated points in the receiver's tuning range.)

The Fairchild FT57, an n-channel depletion-mode FET, has a maximum noise figure of 4.5 dB at 100 MHz (typically 2.7 dB), and a minimum power gain (neutralized) of 15 dB at 100 MHz.

This FET will probably find a good deal of use in FM and vhf television tuners, where signal levels sometimes in

the neighborhood of 100,000  $\mu$ V cause serious crossmodulation problems.

## TINY DIODES FOR TV DAMPERS

Designed for power supplies in the communications field, cathode-ray tube devices, photomultipliers, xerography, electrostatic precipitators, and instrumentation requiring high voltages, this tiny Codistor II silicon rectifier can work at voltages as high as 100,000. No supplementary resistor or capacitor is needed.



The Codistor II rectifiers are built by a multiple-junction process developed by Computer Diode Corp. One of the most important applications to date is as a damper in color television receivers.

## PLASTIC-ENCAPSULATED SILICON POWER TRANSISTORS

A silicon power transistor that can dissipate 25 watts at a case temperature of 100°C? That costs less than a dollar even when not purchased by the hundred? That's what Bendix says, announcing the B-5000, a high-gain n-p-n silicon power transistor encased in a hermetically sealed plastic slug.

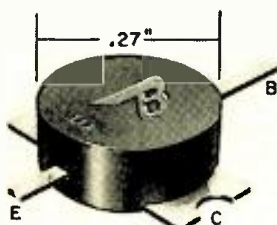

Collector-to-emitter breakdown is 35 volts minimum. The collector can carry up to 3 amperes, the base 1 ampere. Current gain ranges from 30 to 250 at 14 volts and 0.5 ampere. (Presumably the transistors will be supplied to manufacturers in coded subgroups with a tighter current-gain spec. That's a range of more than 8 to 1!) END

## Let these experts answer your questions on **COLOR TV servicing**



### Color TV Repair

10 servicing experts who write for Radio-Electronics magazine reveal tested techniques, practical ideas, tricks-of-the-trade. Shows how to pinpoint defective color section fast, describes trouble-shooting with a color bar generator, outlines causes of TV failure. Includes servicing of chroma circuits, etc. 160 pages, paperback.

Order #123 .....\$2.95

### Servicing Color TV

by Robert G. Middleton. A practical book that shows how to service color TV sets and make money doing it. Includes facts on signal tracing, test equipment, color sync servicing, chroma circuit servicing, matrix testing, etc. 224 pages, paperback.

Order #65 .....\$2.90

### TV Sweep Oscillators

by Harry E. Thomas. A practical, non-mathematical handbook that explains relaxation oscillators, pulse techniques, transistorized oscillators, sawtooth generators, synchronization, failure analysis, sweep oscillator servicing, etc. 226 pages, paperback.

Order #119 (at parts jobbers only) ....\$3.95

### Horizontal Sweep Servicing Handbook

by Jack Darr. Gives you fast, simple methods of locating and repairing troubles in the sweep system. Practical shortcuts, developed on the bench for rapid isolation of trouble. Includes horizontal oscillator, multivibrator, output stage, etc. 224 pages, paperback.

Order #115 .....\$4.10

Order from your Electronic Parts Distributor today, or mail to:

Gernsback Library, Inc., Dept. RE-766,  
154 West 14 Street, New York, N. Y. 10011

Send the following books:

- #123 (\$2.95)
- #65 (\$2.90)
- #115 (\$4.10)

I enclose \$..... (prices 10% higher in Canada)

Name .....

Address .....

City ..... State ..... Zip .....

My distributor is .....

# COLOR TELEVISION SYSTEMS:

July may bring the end of the long deadlock on European color-TV standards. Some proposed systems have vital advantages over ours.

By ERIC LESLIE

AT ONE TIME EUROPE HAD 405-, 525-, 625-, and 819-line broadcast systems. Some unfortunate countries—like Belgium—had to build sets that could receive more than one of them.

If European color TV standards are not agreed on at the Oslo CCIR conference (June 22–July 22), the various nations will likely go their own confusing ways, as they did with black-and-white.

Color may not be so mixed up. There is some hope that one system will be adopted for all Europe, and it is not likely that there will be more than two. Meanwhile, the systems—reasonably distinct and different at the time of last year's Vienna convention—have been changing and blending to a point where it is becoming hard to distinguish which exactly is which.

## Only one color system

The advocates of all the systems insist theirs is just like our NTSC. The fundamental principles are identical. The significant differences are in the methods used to modulate the color subcarrier to transmit chrominance information. The color camera filters the scene into three color components—red, green and blue—each beamed to its own camera tube. The electrical outputs of these tubes—scanned like ordinary black-and-white image orthicons—are the familiar R, G

and B signals. Mixed together again they form the Y (brightness) signal, which is identical to the signal from a black-and-white camera.

Two difference signals, R – Y and B – Y, carry the color information, and modulate a subcarrier. The subcarrier frequency is about 3.58 MHz for 625-line TV. In fundamental NTSC systems, the color signal is phase-modulated onto the subcarrier. Color (really hue) depends on which portion of the subcarrier cycle is modulated. A signal near the beginning of the cycle is interpreted as a shade of blue; one at a little more than 90° (quarter way along the cycle) as a red. The NTSC receiver contains an oscillator that is kept in step with the transmitter subcarrier by a burst of 3.58-MHz subcarrier at the start of each scanning line. The two signals follow: the R – Y first and the B – Y a quarter-cycle after it. No green difference signal need be transmitted, since it can be developed at the receiver as red and blue are reconstituted.

## Sequence and memory (French)

The French SECAM differs from American NTSC more than do the other European suggestions. It transmits the color on R – Y and B – Y signals as does the fundamental system. But, instead of sending the two signals at the same time in quadrature, it transmits

only the R – Y signal during one full scanning line, the B – Y signal on the next line.

The subcarrier is picked out of the video signal by a bandpass amplifier, as in other systems. The amplifier output goes to an electronic switch, which works like this: Let us suppose that in Fig. 1 we are looking at the switch at the instant a line modulated with the R – Y signal is starting. The R – Y signal goes to the corresponding detector and also to the delay line, where it is stored until the beginning of the next scanning line. As that line (B – Y) comes through the bandpass amplifier, the switch moves to the lower position (on the diagram) and the signal goes through to the blue detector. At the same time, the red signal appears at the output of the delay line and is fed to the red detector, and a blue (B – Y) signal enters the delay line.

Thus, after the first line, two color signals are fed to the matrix simultaneously, though these signals come from two successive scanning lines. Experiments confirm the fact that the difference in content between two successive scanning lines in a 625-line frame is so slight as to be practically imperceptible.

The two difference signals are combined with the brightness signal, which comes directly to the matrix from the video stages, to obtain the red and blue signals. The remainder is the green signal as in NTSC. Special synchronizing pulses (analogous to the color burst of NTSC) keep the "switch" at the receiver in step with that at the transmitter.

The frequency-modulated subcarrier (with a swing of 700 kHz) is so insen-

## THOSE ABBREVIATIONS

**ART**—The NTSC system with Additional Reference Transmission

**NIIR**—National Radio Research Institute (Russian)

**NTSC**—National Television Systems Committee (named after an all-industry engineering group who developed U.S. color-television specifications). Now describes American system of color telecasting

**PAL**—Phase Alternation Line

**SECAM**—Sequentiel a Memoire, or sequential-with-memory (the French qu is pronounced like hard c and was put that way so the abbreviation

would be spoken the same way in all languages)

**SEQUAM**—The abbreviation QUAM came into being at the 1965 Vienna conference to describe QUadrature Amplitude Modulation, a term that can be applied to both NTSC and PAL, and expressed a hope that the American and German systems could reach a compromise. It is from this term that SEQUAM comes. The system it describes is the same as SECAM IV and NIIR

**CCIR** is the abbreviation for the French version of International Consultative Committee on Telecommunications

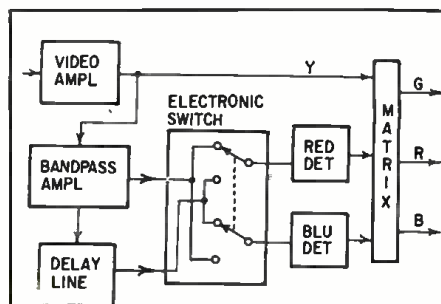

Fig. 1—SECAM system, block diagram, switching and detection components. No tint or hue controls are needed, which fact makes SECAM color sets as easy to operate as black-and-white receivers.



# WHICH WAY WILL EUROPE GO?

sitive to phase and amplitude distortion that color controls are not needed. The receiver is as easy to operate as a black-and-white set.

PAL resembles the American system most closely, and may be thought of as NTSC with cancellation of phase errors. Hue depends on the relative phases of the elements in the color signal, so anything that changes those phase relationships anywhere between the camera and the TV screen will change the color. For example, suppose that the camera is focused on a red object and that the correct phase for red is the dashed line of Fig. 2. If the color signal is delayed in passing through any of the networks in the transmitter or receiver, it may arrive a few degrees late (Fig. 2-a), or toward the green.

PAL corrects this by reversing one of the modulation axes (the I axis on the original PAL version, the R - Y axis on the latest variation) and then shifting it 180°. This puts the red signal as much *ahead* of correct phase in the second line as it was *behind* in the first. Hue would now be shifted toward the magenta, and the average of the two would give the correct color (Fig. 2-b).

A receiver can actually be operated this way, with the eye acting as a sort of matrix and averaging the line to get correct color. The cheaper PAL system (VolksPAL) works just that way. But for large phase errors there is a peculiar Venetian-blind effect and "eye fatigue" sets in. The better circuit uses a delay line, as SECAM does. Fig. 3 is a block diagram of that circuit. Each line is averaged electronically in the matrix with the preceding line, and errors are thus cancelled.

Since phase errors are hue errors, PAL needs no hue control. PAL without the control has truer color than NTSC with it. But, since correcting large phase variations cuts down brightness, PAL does need a saturation control.

## An ARTful device

Phase distortion may also vary with the Y-level (strength) of the signal. Thus the color may be correct at the beginning of a line and wrong in the middle of it, if the brilliance in the scene changes greatly. No manual or line-by-line type of automatic hue control can cope with this kind of color error.

Another German system supplies an additional reference signal to synchronize the subcarrier oscillator in the

receiver. This system is referred to as NTSC with *Additional Reference Transmission*, or ART. The reference oscillator is in phase with one of the color signals (the I or R - Y), and rides up and down with color-signal strength, instead of being fixed at the sync backporch level like the NTSC color burst. The reference-transmission signal is reversed for each alternate line and fed into the demodulators through a delay line, as with PAL, so that distortion is cancelled.

Unfortunately, ART is not as compatible with black-and-white as any of the other systems, and is harder to record on tape than straight NTSC. (It is interesting to note that, should we wish to improve our American color, NTSC transmitters and receivers can readily be adapted to PAL or ART.)

Which is best? As in many other things, there is no best. NTSC costs the least and has a long record of practical use to prove its reliability. A SECAM set is simplest to operate (like a black-and-white receiver) and the SECAM signal is easiest to record—can be recorded on an ordinary black-and-white video recorder. PAL is claimed by its advocates to show slightly better color under adverse conditions. It is a question which of these factors engineers consider is most important.

But, just as the various committees,

subcommittees and conferences had finally agreed that all the parameters have been set and that no more tests are needed, and they were now ready to thresh out their differences at Oslo, a voice was heard from the South. A new Russian system was discussed in Rome by the French delegates at a conference of the European Broadcasting Union. There is no word on whether it has been tested, or even exactly what it is. Called NIIR by the Russians and SECAM IV or SEQUAM by the French, the details revealed so far lead one to believe it is a sort of cross between PAL and ART, with the phase correction of the one and the additional reference transmission of the other. The features of the older SECAM seem to have disappeared in the merger.

Apparently the main features of the new system were political, combining as they did the two competing systems. However, France and Russia later officially joined in approving SECAM III. (The III refers to certain specifications concerning the direction of modulation of one of the color signals and of the amount of deviation). Therefore, it is not likely that SEQUAM will be one of the systems introduced at the Oslo conference. However, it remains in the background as an interesting dark horse.

END

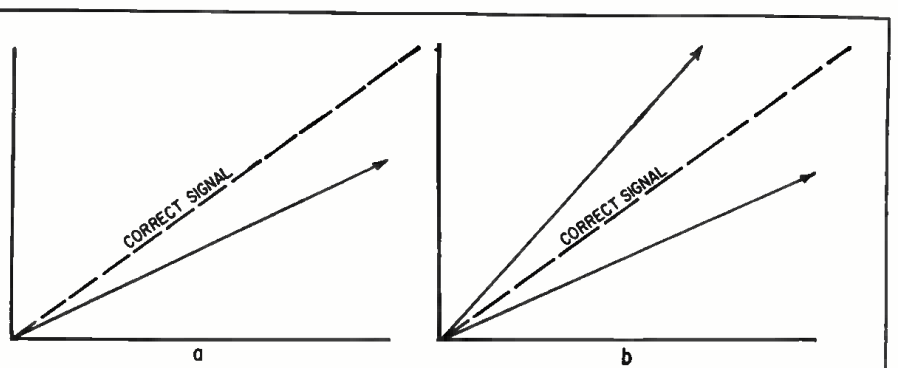
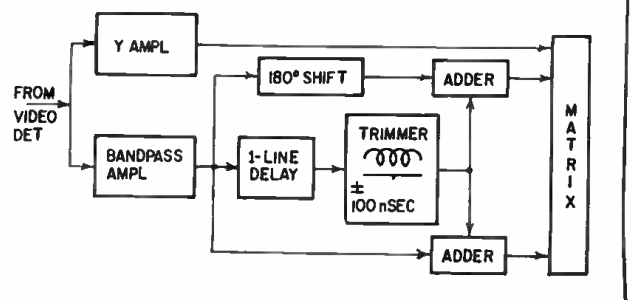

Fig. 2—How PAL corrects wrong phase.

Fig. 3—PAL detection system, block diagram. The original signals to the matrix were I and Q; in the newer PAL they are R-Y and B-Y. Crux of this system, as in SECAM, is a one-line delay.



# What are you doing about car stereo?

The 4-Track Market Is Here!



Craig Car-Stereo is your answer. Lots of consumer electronics people are picking up extra profits with the Craig line.

It's the best line on the market. Loaded with quality you can sell. Quality electronics you and your customers can count on.

Along with the 4-track, dual-head Car-Stereo line, you've got a huge tape cartridge music library that keeps the profits coming in.

Craig Car-Stereo is your answer. Drop us a line for the name of your nearest distributor.

The 4-track market is here and it's yours for the selling!

**Φ CRAIG PANORAMA, INC.**

2302 East 15th Street • Los Angeles, Calif. 90021 • (213) 623 2421 • TLX 76-4116

Circle 32 on reader's service card

## EIGHT INSTRUMENTS IN ONE



- Out-of-Circuit Transistor Analyzer
- Dynamic In-Circuit Transistor & Radio Tester
- Signal Generator
- Signal Tracer • Voltmeter
- Milliammeter
- Battery Tester
- Diode Checker

### Transistor Analyzer Model 212

Factory Wired & Tested — \$18.50

Easy-to-Assemble Kit — \$13.50

**YOU DON'T NEED A BENCH FULL OF EQUIPMENT TO TEST TRANSISTOR RADIOS!** All the facilities you need to check the transistors themselves — and the radios or other circuits in which they are used — have been ingeniously engineered into the compact, 6-inch high case of the Model 212. It's the transistor radio troubleshooter with all the features found only in more expensive units. Find defective transistors and circuit troubles speedily with a single, streamlined instrument instead of an elaborate hook-up.

#### Features:

Checks all transistor types — high or low power. Checks DC current gain (beta) to 200 in 3 ranges. Checks leakage. Universal test socket accepts different base configurations. Identifies unknown transistors as NPN or PNP.

Dynamic test for all transistors as signal amplifiers (oscillator check), in or out of circuit. Develops test signal for AF, IF, or RF circuits. Signal traces all circuits. Checks condition of diodes. Measures battery or other transistor-circuit power-supply voltages on 12-volt scale. No external power source needed. Measures circuit drain or other DC currents to 80 milliamperes. Supplied with three external leads for in-circuit testing and a pair of test leads for measuring voltage and current. Comes complete with instruction manual and transistor listing.

EMC, 625 Broadway, New York 12, N. Y.

Send me FREE catalog of the complete value-packed EMC line, and name of local distributor.

NAME \_\_\_\_\_ RE-7

ADDRESS \_\_\_\_\_

CITY \_\_\_\_\_ ZONE \_\_\_\_\_ STATE \_\_\_\_\_

## EMC

ELECTRONIC MEASUREMENTS CORP.  
625 Broadway, New York 12, New York  
Export: Pan-Mar Corp., 1270 B'way, N. Y. 1

# TECHNOTES

## HEAT DAMAGE TO CAPACITORS

Certain capacitor types in recent sets can be ruined by excessive soldering-iron heat. They look like miniature silver-colored paper capacitors with axial leads, and are generally mounted away from the circuit board on long leads.

These capacitors are prone to heat damage because of their polystyrene dielectric and covering, which has a comparatively low melting temperature. Use a heat sink for removal or replacement, and don't allow a hot soldering iron to touch the capacitor body.—*G-E Service Talk*

## SECURING LOOSE CRT BASES

A loose base may mean a premature end for a picture tube—it may be pulled off when the socket or yoke is removed, breaking the internal connections.

To fasten the base permanently, cut two lengths of plastic electrical tape, each about 1 inch longer than the circumference of the CRT base. Wrap one piece tightly around the tube right over the place where base and neck join, with about half the width of the tape on the base and half on the neck.

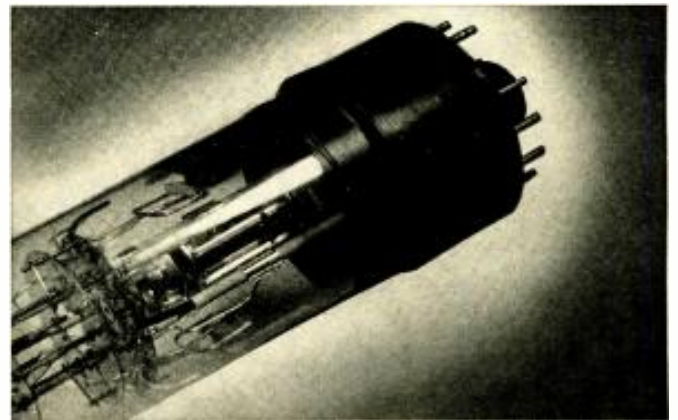

Now wrap the other piece around the same place but in the opposite direction, starting so that the lapped ends will be on the opposite side of the neck from the joint of the first wrap. This counteracts the tape's tendency to loosen as the adhesive creeps with age and heat.

If the tape conceals the tube type or coding, mark the information on the bulb or neck with a felt-tip pen.—*Harold J. Weber*

## SYLVANIA 19P11W: HORIZONTAL "DANCE"

This particular set had an interesting defect: from time to time the picture would jump an inch or two from side to side. It did that often enough to be annoying. The horizontal hold was unaffected; so was everything else. The picture just jumped from side to side.

The place to look is in the agc line to the tuner. Change a 0.22- $\mu$ F 100-volt capacitor (C214) there and you cure the dance.—*Sid Elliot*

## SHORT-LIVED 12L6 TUBES

Short 12L6 life? Replace with a 12W6. The two tubes are identical except that the 12W6 has higher maximum voltage and current ratings, and is designed for vertical output service. The 12L6 is commonly used as audio output tube in stacked-B-plus circuits. Incidentally, since the basic characteristics of 12L6 and 12W6 are identical, tube stock can be reduced by using the 12W6 as a replacement for the 12L6. Several set designers have used the 12W6 and its 6-volt

RADIO-ELECTRONICS

# What you don't know about TV, Transistors & Test Instruments, may be costing you a promotion or a pay raise!

Here is an extraordinary offer to introduce you to Gernsback Library's famous Electronics Book Club, specially designed to help you increase your know-how and earning power.

## WHY SHOULD YOU JOIN!

Whatever your interest in electronics—radio and TV servicing, audio and hi-fi, industrial electronics, communications, electronics as a hobby—you'll find that the Electronics Book Club will help you get the job you want, keep it, improve it, or make your leisure hours more enjoyable. By broadening your knowledge and skills, you'll build your income and electronics enjoyment as well.

## WHAT BOOKS ARE OFFERED?

From Gernsback Library and other leading publishers come the country's most respected books in the field of electronics. All are deluxe, hard-covered books of permanent value, offered at considerable cash savings to members, regardless of higher retail prices.

## HOW THE CLUB WORKS

The Electronics Book Club will send you, every other month, the News Bulletin describing a new book on a vital area of electronics. As a member, *you alone* decide whether you want a particular book or not. You get 3 books now for \$1.99 and need take only 4 more within a year, from a wide selection to be offered. And the Club *saves you money* on the books you take, regardless of higher retail prices.

## HOW TO JOIN

Simply mail the coupon today. You will be sent your three handbooks—BASIC TV COURSE, FUNDAMENTALS OF SEMICONDUCTORS and THE OSCILLOSCOPE (regular retail price \$15.55). We will bill you \$1.99 (plus a few cents postage). If you are not pleased with the books, send them back within 10 days and membership will be cancelled. Otherwise you will enjoy these benefits:

- ★ Get three books immediately for \$1.99 (regular \$15.55 value).
- ★ Free 10-day examination privilege.
- ★ Continuous cash savings.
- ★ Free charts and reports given with many books.
- ★ You alone decide which books you want. Books are returnable.
- ★ Club Books are practical working tools, written by experts.

Get these three income-boosting books... a \$15.55 value

**\$**  
only **1.99**

by joining the Electronics Book Club today!

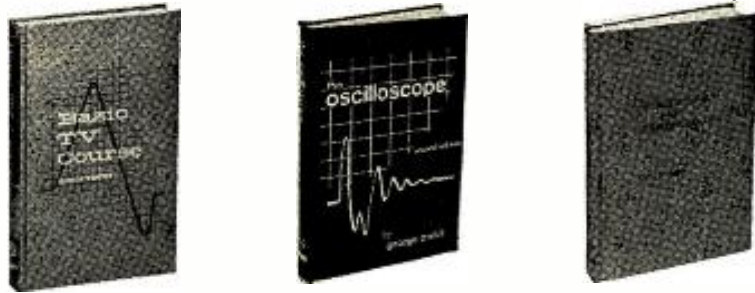

### BASIC TV COURSE

By George Kravitz. Perfect introduction to TV, in clear, non-mathematical language. Starting with the forming of the picture, the book shows how the picture tube works, the television signal, the television receiver, antennas and tuners, how the video IF works, the video detector and AGC, the video amplifier it work, how the sync section works, horizontal output and high voltage supply, how the sound section works, how transistor portable TV's work. 224 pages, completely illustrated. Retail Price \$5.75.

### FUNDAMENTALS OF SEMICONDUCTORS

By M. G. Scroggie. Provides a complete background in semiconductor devices, beginning with basic facts on electrical conduction through transistors, rectifiers, photoelectric devices, thermistors, varistors, diodes, cryosars, etc. Supplies enough theory in a simple way to make it possible to understand more advanced literature. Also explains how the special properties of semiconductors are being applied in many kinds of useful devices. Dozens of charts, diagrams and photos. 160 pages. Retail Price \$4.60.

### THE OSCILLOSCOPE

By George Zwick. (Revised Edition). Teaches you how to operate the scope, how to use it for alignment and shows you how to solve every type of service testing problem you are likely to encounter. Demonstrates how to interpret waveforms correctly, how to use scope probes, how to measure low input voltages, how to perform specific experiments using the oscilloscope, etc. 224 illustrated pages. Retail Price \$5.20.

Gernsback Library, Inc., Electronics Book Club, Dept. RE 76

154 West 14th Street, New York, N.Y. 10011

Please enroll me in the Electronics Book Club and send me the 3 income-boosting handbooks: BASIC TV COURSE; FUNDAMENTALS OF SEMICONDUCTORS; THE OSCILLOSCOPE. Bill me only \$1.99 plus shipping (for this \$15.55 value). If not pleased, I may return the books in 10 days and this membership will be cancelled.

As a member, I need only accept as few as 4 additional books a year—and may resign any time after purchasing them. All books will be described to me in advance, every other month, in the Club Bulletin, and a convenient form will always be provided for my use if I do not wish to receive a forthcoming book. You will bill me the special Club price for each book I take (plus a few cents postage)—regardless of higher retail prices. Offer good in U.S.A. and Canada only.

Name .....  
(Please Print)

Address .....

City ..... State ..... Zip Code .....

SAVE: Enclose your \$1.99 now with this coupon and we will pay postage. Same return guarantee privilege; prompt refund if not satisfied.

equivalent, the 6W6, as an audio output tube in stacked-B-plus sets. There is also a chance of finding a similar situation in 6-volt parallel-heater sets, where the "6-volt 50L6" is the 6DG6.—*W. J. Stiles*

### EMERSON T1810: VOLUME CONTROL AFFECTS CONTRAST

On this set, the customer found he had to turn the volume up full to get a picture. I discovered a shorted coupling capacitor at the grid of the audio output tube. This was a stacked-B-plus set, and the large drop through the wrongly biased output tube killed the voltage to the video stages.—*Norm Leverich*

### DUMONT 208 OSCILLOSCOPE

This old scope is hard to beat for industrial electronic applications. It is stable, linear and has a wide dynamic range. After many years of service, the dynamic range may gradually decrease, with a noticeable overloading in the vertical amplifier. When this happens, check C9 in Fig. 1—a slight amount of leakage shifts the grid bias on V3.

Here's another trouble symptom: if the Y position con-

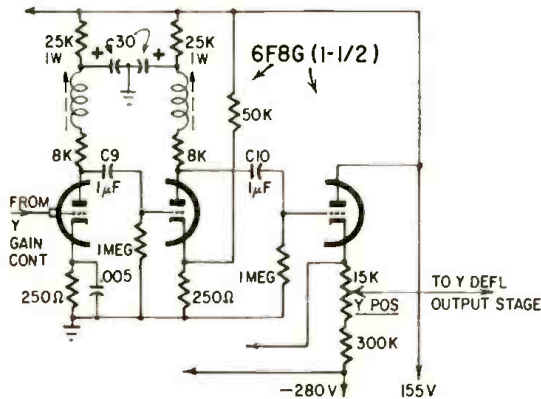

Fig. 1

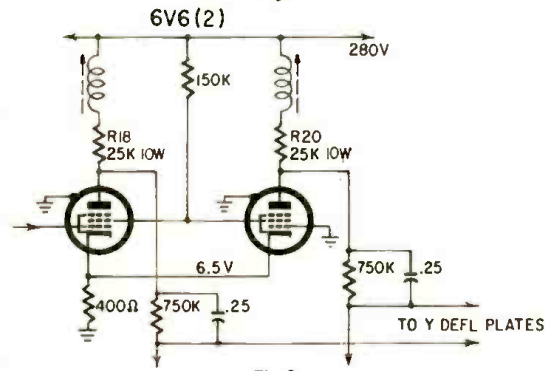

Fig. 2

rol drifts out of range, check C10—leakage shifts the grid bias on V4. Both C9 and C10 are 1-μF capacitors. We paralleled two 0.5-μF Tiny Chiefs to make 1μF, and used 400-volt capacitors to reduce the possibility of breakdown. (The original 1-μF capacitors were rated at 200 volts.)

Still another trouble symptom: if the CRT goes blank, check R18 and R20 (Fig. 2). These are 25,000-ohm 10-watt resistors. We found R18 burned out; within 20 minutes, R20 followed. Both were replaced with 20-watt resistors. Now the old scope is good as new.

Whenever you work with scope circuitry, always double-check to make sure the high-voltage filter is discharged. You could get a fatal shock otherwise. Although the CRT accelerating voltage is much lower than in a TV set, the current capacity of the supply is tremendously greater. It is the current that kills at any voltage. Note also that the high-voltage circuitry in a scope differs from that in a TV set; the heater, cathode and control grid of the CRT operate at a high negative voltage.—*Robert G. Middleton* **END**

**Two NEW Mercury instruments designed to meet today's rigid requirements in troubleshooting Color TV, B/W TV, Radio, Hi-Fi and Communications equipment**  
*...high input impedance prevents circuit loading*

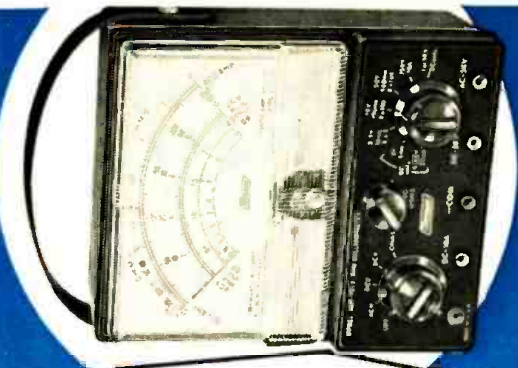

**Model 1800 VOLT-OHM MILLIAMMETER**  
**1.5 volt full scale**  
**.25 volt full scale**  
 enables you to handle solid state testing easily and accurately  
 High impact durable housing... large 6" easy-to-read meters

**AC VOLTS:** (6 Ranges) 0-2.5, 10, 50, 250, 1000, 5000v. Input Resistance — 5k Ohms/Volt. Accuracy — Better than 4%.

**DC VOLTAGE:** (8 Ranges) 0-0.25, 1, 2.5, 10, 50, 250, 1000, 5000v. Input Resistance — 20,000 Ohms/Volt. Accuracy — 2%.

**DC CURRENT:** (6 Ranges) 0-50ua, 1ma, 10ma, 100ma, 500ma, 10a. Accuracy — 2%.

**OUTPUT — Decibels:** (4 Ranges) —20 to —10db, —8 to —22db, —6 to —35db, —20 to —50db. ODB — 1 mw across 600Ω load.

**RESISTANCE:** (3 Ranges) 0-2k, 200k, 20 megohms. Accuracy — 2%.

**\$3995** Net



**Model 1700 VACUUM TUBE VOLT METER**  
**1.5 volt full scale**  
**.25 volt full scale**  
 enables you to handle solid state testing easily and accurately  
 High impact durable housing... large 6" easy-to-read meters

**AC RANGES:** (7 Ranges) 0 to 1.5, 5, 15, 50, 150, 500, 1500v. Peak to Peak — (7 Ranges) 0.4, 14, 40, 140, 400, 1500v. Output (DBM): (7 Ranges) —20db to 65db. ODB 1 mw across 600Ω. Input Impedance — 1.4 megohms. Frequency Response — 30 ~ to 500kcs within 3%. Accuracy — within 5%.

**DC RANGES:** (7 Ranges) 0-1.5, 5, 15, 50, 150, 500, 1500v. Input Impedance — 11 megohms. Accuracy — 2%.

**RESISTANCE RANGES:** (7 Ranges) 0-1k, 10k, 100k, 1 meg, 10 meg, 100 meg, 1000 meg. Accuracy — within 3%.

**POWER CONSUMPTION:** Less than 10w.

**\$3995** Net

**MERCURY ELECTRONICS CORP.** 315 Rosilyn Road, Mineola, N.Y. 11501  
 See your parts distributor or write for complete catalog  
 William Cohen Corp. Mercury, N.Y.C. 10013  
 Morben Exporting, 43b Broadway, N.Y.C. 10013  
 Export

# Hunting Horizontal Output Troubles

Replacing a flyback "just to see" is a terrific waste of time. First find out if it's bad. A few simple tests will tell you. **By WILLIAM DARRAGH**

LET'S DISCUSS HORIZONTAL OUTPUT stages and their many troubles. Since we'll be talking about nothing but horizontal circuits, let's just say "oscillator", "output", etc., and save time, OK?

Before we go any further, let me get in just a little "dutch-uncle-ing." A lot of you guys have a tendency to go off half-cocked in this stage. You replace flybacks, yokes and things without enough testing, then stand there with your lip stuck out! "I changed the flyback and it still won't work!" Replace tubes or anything that plugs in, but *don't* replace the big things without making *sure* they're bad! It can be done, and we're going to tell you how. Replacing these parts without enough testing is wasting time (read "money" for that).

There are tests—easy tests—that will tell you if a flyback is bad. One test can fool you, but if you get the same answer on two or more, you're OK. Take time to make sure—more perfectly good flybacks are replaced than any other TV part!

Now, let's go. What to do when we get a set with the classic symptoms:

sound, no raster? Look for the obvious causes first: dead tubes, blown fuses, no B-plus voltage. Fix these and you catch a majority of 'em. The hard ones are the "almost" sets: all tubes lit, B-plus pretty good, but no raster. Then we have to dig.

Do all the "standard" things: replace all tubes at the same time—oscillator, output, damper, high-voltage and low-voltage rectifiers. Check voltages on output tubes, and check the boost. Check the high voltage: you may have a bad picture tube! A neon-bulb hv tester is handy, for seeing if there is "rf" in the hv cage and around the flyback. The hv lead can be arced to the chassis. Now we're ready to get into some tests that have real meaning.

This is a pretty complicated-looking stage. Everything is tied together like Murphy's shoestrings. Everything affects everything else! Don't let this throw you; all we need is the right test to tell us what's going on. Where? In the horizontal output tube.

This tube furnishes the "push" for everything else. Every bit of current used in sweep, boost, hv, etc., comes

through that output tube! Anything that happens in any part of the circuit is going to affect the plate current of the output tube. So let's measure it to see if it is normal.

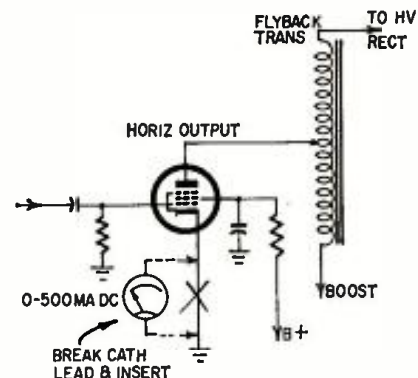

Fig. 1—Measuring total cathode current in output stage is a very important test.

Connect a 0-500-mA dc meter in the cathode of the horizontal output tube (Fig. 1). You'll find the right value printed on the schematic alongside the cathode; Sams Photofacts have been doing this for years. The easiest way to measure is with a test adapter. Fig. 2 shows how to make one. Old tube base, octal socket and two pieces of test lead wire. Wire it straight through, except for the cathode. This is pin 8 on 6BQ6, 6DQ6, etc., pin 3 on 6CD6, 6BG6, etc. You should make one for each tube type; label each with a piece of adhesive tape, or the stickers from a set of shelf-labels, as on the one shown in the photo. (Incidentally, the little tab on the left side of this one is connected to the grid. Very handy for checking drive.)

Now we're ready. If we have too little current, this means a weak tube, low B-plus voltage, low screen-grid voltage or an open circuit in one of the loads—an open yoke, for example. These can be traced out one at a time and fixed.

Most of our troubles will show up as too-high plate current. This causes flyback overheating, short life for the output tube, and all sorts of unpleasant things like that. So, when we find a



Home-made cathode-current adapter in use. See Fig. 2 for construction. Tab on left side of base goes to grid pin. You can check grid drive from above the chassis.

**PYRAMID**  
YOUR PROFITS!  
NEW

**NEW**  
70+5  
OFF

Name brand tubes, individually boxed, date stamped. Unlimited 1 year guarantee assures top quality. Prices are 70+5 off Mar. '66 sugg. list. Q'tys 50 or more. Just check off your order and send us a check.

Type	Asst'd.* 50 or More	Type	Asst'd.* 50 or More	Type	Asst'd.* 50 or More
024	.68	6BN6	.86	6SL7GT	.96
1B3/1G3GT	.79	6BN8	.90	6SN7GTB	.70
1G3GT	.79	6BQ5/EL84	.66	6S07GT	1.07
1B3	.79	6B06GA/		6T8A	.91
1B5	.91	6C05	1.17	6U8A	.88
1U4	.87	6B06GTB/		6V6GTA	.59
1U5	.76	6C06	1.17	6W4GT	.66
1Y2	.63	6B07A	1.07	6W6GT	.77
1X2B	.83	6BR8A/		6X4	.46
2AF4B	1.08	6FV8A	1.10	6X5GT	.60
2BN4A	.79	6B50	1.07	6X8A	.86
2C15	.87	6B08	.77	7A07	.70
3A3/3AW3	.91	6B7B	.99	8A8BA	1.00
3A05	.63	6B7A	.67	8C07	.67
3AW3	.91	6B7Z	1.07	8F07	.67
3BC5/3CE5	.70	6C4	.50	100E7	.91
3BN6	1.03	6CB6A	.60	12AD6/	
3B26	.62	6C06GA	1.57	12G6A	.74
3CB6	.62	6CE5	.65	12AT6	.50
3CE5	.70	6CF6	.79	12AT7	.82
3C15	1.07	6CG7	.67	12AU6/	.57
3D04	1.17	6CGBA	.88	12AU7/	
3D06A	.67	6CL6	1.08	6CC82	.68
3GK5	1.10	6CL8A	1.07	12AV5GA	1.28
3V4	.74	6CM7	.79	12AV6	.46
4B07	1.10	6CN7	1.14	12AV7	.97
4B07	1.19	6CQB	.94	12AX4GTB	.73
4B26	.60	6C56	.70	12AX7/6CC83	.68
5A8B	1.16	6C17	.80	12AX7A	.68
5A8B	1.27	6C05	.77	12A7A	.82
5A05	.68	6C16	1.17	12B4A	.87
5A7B	1.08	6C08	.60	12C05	.78
5BR8A	1.20	6C04	1.25	12C06	1.20
5CG8	.90	6C28	1.22	12D06B	1.13
5CL8A	1.10	6C75	.99	12D75	.88
5T8	1.29	6C77	.87	12E06B	1.13
5U4GB	.54	6C25	1.17	12C06	1.20
5U8	.88	6D44A	.87	12B77A	.87
5X8	1.07	6DEA	.87	12C5/12C05	.78
5Y3GT	.70	6DEE	.68	12C5A	.82
6A4	.70	6DEE	.96	12C05	.78
6AF3	.88	6DR6	.65	12C06	1.20
6AF4	1.07	6D07	.96	12D06B	1.13
6AF4A	1.07	6D05	2.24	12D75	.88
6AG5	.82	6D06B	1.11	12G6A	.74
6A94GT	.93	6D7	1.17	12SA7GT	1.25
6A96	1.25	6D7A	.59	12S7GT	1.14
6A95	1.20	6D94A	1.00	12S7GTA	.73
6A96	.85	6EA7	1.48	12S07GT	1.07
6AL5	.50	6EAB	.86	12V6GT	1.07
6A8BA	.93	6EB8	1.25	12W6GT	1.07
6A8BA	1.07	6E77/EF184	1.02	13E07/	
6A05A	.57	6EM5	.91	15EA7	1.38
6A55	.79	6EM7	1.37	15EA7	1.38
6A58	1.14	6E85	1.02	16A03	.77
6A7BA	1.14	6E85	.82	17AX4GTA	.87
6A04GTA	.97	6E9A	.67	1704A	.87
6A06A*	.56	6FG7	1.02	17006B	1.13
6A08A	1.25	6FN5	.90	17J2B	1.02
6A76	.46	6F07	.67	19A04GTA	1.02
6A76A	1.00	6F0A	1.10	19T8	1.05
6AX3	.73	6GF7	1.39	220E4	.97
6AX4GTB	.71	6GH8A	.86	25B06GTB/	
6AY3A	.83	6GK5	1.10	25C06	1.25
6B10	.96	6G08	.79	25C06B	1.44
6B10	.54	6GNB	1.17	25C06	1.25
6B8A	1.14	6GU7	.91	250M6	1.20
6BC5/ACES	.65	6GV6	.74	25L6GT	.79
6BC	1.07	6H5B/6KFB	1.02	35C5	.57
6BE6	.60	6J5GT	1.05	35L6GT	.70
6B06GA	1.74	6J6A	.76	35W4	.30
6B06	.79	6J86	1.67	35Z5GT	.56
6B08	1.14	6JE6	2.42	50C5	.57
6B16	.79	6JH6	.70	50EH5	.83
6BK4A	2.16	6JUB	.96	50L6GT	.87
6B25	1.00	6K6GT	.70	6CC82	.68
6B7B	1.02	6KFB	1.02	6CC83	.68
6B7GTA	1.25	6L6C	1.27	6CF80	1.67
6B1B/ECF80	1.07	654A	.68	EF184	1.02
6B4A	.97	657GT	1.11	EL84	.66

\*Less than 50 assorted, 60% off list.  
TERMS: Minimum order \$5.00 exclusive of postage. Orders for 200 or more tubes shipped prepaid.  
FREE: Send for special list of private brand, fully guaranteed new tubes at special discounts up to 80% off Mar. '66 suggested list.  
CHECK OR MONEY ORDER — NO C.O.D.  
LIMITED TIME WITH YOUR ORDER

POPULAR NAME BRAND AC-DC KIT	3 — 35W4 3 — 50C5 2 — 12BE6 1 — 12AV6 1 — 12BAG	ONLY \$3.45
------------------------------	---	-------------

TOTAL 10 TUBES

**PYRAMID ASSOC., INC.**  
16365 N.W. 15th Ave. Miami, Florida 33169

6BQ6 with a current around 150 mA (normal, 95 max!), we'd better find and fix, or we'll get a callback.

The first step would be to take off all the loads. Pull the damper tube, disconnect the yoke and take off the width coil, if there is one. Now, check the current again. If the flyback is OK, current will drop to about 30-40 mA. This would mean a good flyback, with a short in one of the external loads. So, put them back one at a time, and see which one sends the current soaring.

First, let's suppose that we have taken off all the loads, and we still get too much current—about 85-90 mA, for instance. This could mean that the flyback was shorted internally. It will get too hot. Normally, a flyback running "open" (without load) will stay pretty cool. Check the dc resistance of the windings. On small windings, resistance readings are meaningless, but if you find a big winding, say about 400 ohms, that reads 200 ohms, then there is probably a short. If you have a "flybacker" or other flyback tester, try it. If all three tests agree, saying the flyback's shorted, you can be pretty sure. Replace it.

Now, if we have too much current but it drops to normal when the flyback is "unloaded", our short is external: yoke, damper, boost, or even the vertical output or some other circuit fed from the boost voltage. Same method: put them back one at a time.

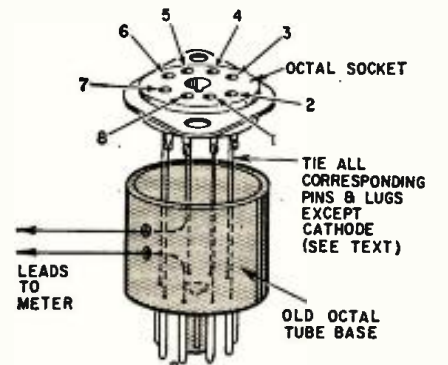

Fig. 2—Checking cathode current is fast with adapters. You need one for each type output tube base. You can make them for tubes with Bakelite bases and buy them for the tubes that have glass headers.

Flyback and yoke testing are tied together, since they work together. The main clue to yoke trouble is always missing boost voltage. If you have no boost or very little boost (say about 100 volts above the B-plus voltage when it's supposed to be about 400 volts more), suspect the yoke. This trouble will usually show high plate current in the output tube, too.

There's a quick check: disconnect the yoke. Current drops to normal. Now, hook up the horizontal winding of another yoke, no matter whether it

matches or not. If the current rises to almost normal and the boost comes back, then the original yoke's bad. We can use this test even if the test yoke is so far "off" that it wouldn't work on the set. If the horizontal windings are good, it will bring the boost back up. Replace only with an exact duplicate of the original, of course.

Shorts or leakage in the boost capacitor, or boost-circuit loads—for example, a shorted vertical output transformer, shorted width coils—anything like this can be spotted by simply disconnecting it from the "source" and checking the current. If the current drops from an overload to about normal for this condition, fine: we've found something.

**The horizontal drive**

The output tube works class-C: plate current flows only in small pulses, at a level which would be a 500% overload if it flowed all the time! Operation like this depends entirely on the grid bias: the horizontal drive. Unless this is high enough to keep the grid voltage up, the tube will not be cut off as long as it should be, and the average plate current will skyrocket. So, if you find very high plate current, and supply voltages OK, check the peak-to-peak voltage on the grid.

Once in a while, you'll find a "marginal" case; you wonder whether this is the trouble or not. There's a simple way to find out: feed in a drive signal from another TV set, or from one of the testers that supply grid-drive test signals. If this cuts the plate current to normal and brings up the hv, boost, etc., then look into the oscillator circuit. A very small dc leakage in coupling capacitors is enough to kill a part of the negative bias; suspect these every time!

So there you are. This circuit is pretty simple, once you learn it, and learn what each reading and reaction means. Learn to test this stage out methodically, not overlooking anything, and to always make more than one test for the big things, like flybacks. If your first test is right, the rest will agree with it. If it wasn't, then you will have saved yourself a lot of wasted time and expense. There is only one real, sure-fire test that tells you at first glance that a flyback is bad: when you look into the cage and see it lying in a charred heap at the bottom!

Next article, the tricks of the trade: a lot of quick checks, gadgets and time-saving things that have been worked out in actual practice for checking out horizontal output stages. However, they're just faster ways of doing the basic job we've been talking about here. Use the right test methods, and your shop will look a lot less like a kennel! END

Coming Next Month

# Radio-Electronics Test Instrument Special Issue



Here are some of the features  
you will enjoy:

- **IS THAT DISTORTION IN YOUR SCOPE?**

If your scope patterns start looking 'funny', especially if they look funny on all jobs, then it's time for a checkup. It's easy to do, once you know these simple steps.

- **PUT YOUR OHMMETER BACK IN SHAPE**

It's simple to find and repair this very common trouble that occurs in ohmmeters when accidentally placed in a hot circuit. Complete do-it-yourself details.

- **CALIBRATING SIGNAL GENERATOR FREQUENCY**

Discover how to calibrate RF generators accurately, and how to avoid the common pitfalls which await the beginner.

- **DOZENS OF VALUABLE FEATURES INCLUDING:**

Build Your Own Pulse Generator  
Scope Waveform Analysis  
Measuring Shock and Vibration  
Build Yourself a Scope-Mobile  
Trigsweep Updates Inexpensive Scopes  
Simple Scope Switch  
Poor Man's Digital Voltmeter  
Many Others

all in August

## RADIO-ELECTRONICS

on sale July 21 at newsstands and parts jobbers

add an fm-stereo service center  
with this one new  
sencore unit!



### THE SENCORE MX129 FM STEREO MULTIPLEX GENERATOR & ANALYZER

FM-Stereo growth continues to mount and is fast becoming as big a field as Color TV. This means more FM-Stereo service business for you, now and in the future. Is your shop equipped? It can be — completely and economically — with the MX129, the FM-Stereo "Service Center in a Case." The instantly stable, 19-Transistor, crystal controlled MX129 is the most versatile, most portable (only 7½ pounds), most trouble free and efficient multiplex unit on the market — just like having your own FM-Stereo transmitter on your bench or in your truck. Powered by 115 volts AC, it produces all signals for trouble shooting and aligning the stereo section of the FM receiver . . . can be used to demonstrate stereo FM when no programs are being broadcast. Self-contained meter, calibrated in peak to peak volts and DB, is used to accurately set all MX129 controls and as an external meter to measure channel separator at the FM-Stereo speakers. **NO OTHER EQUIPMENT IS REQUIRED.** only **\$169<sup>50</sup>**

SIGNALS AVAILABLE FOR ALIGNMENT, TROUBLE SHOOTING AND ANALYZING:

FM-RF carrier with composite multiplex audio signal with 38kc suppressed carrier, 19kc pilot and 67kc SCA signals • Multiplex signal formed by 60 or 1000 cycle internal tones or any external signal • Full control over left and right channel amplitude (modulation) • External 67kc SCA signal available for trap adjustment • Composite signals available for signal injection FM detector •

*professional quality — that's the difference!*

## SENCORE

426 SOUTH WESTGATE DRIVE • ADDISON, ILLINOIS

Circle 36 on reader's service card

# TRY THIS ONE

## LARGE GROMMET FROM TV STANDOFFS

Have you ever needed a large hole grommet to take care of two or more large wires coming from a radio or TV chassis? You can easily acquire one by simply removing the plastic grommet



from a TV lead-in standoff. The uhf-vhf combination filler serves best for three or more wires. Drill a large hole, the same size as the inside diameter of the wire standoff. Insert the plastic grommet, and you're in business.—*Homer L. Davidson*

## ASBESTOS JACKET PROTECTS ELECTROLYTICS

Sets keep coming in with dried-out electrolytics, because of the heat from

line-dropping resistors. I use asbestos to insulate them.

Dampen the asbestos for bending, roll it around the capacitor and let it dry. Do the same around the resistor where it is nearest the capacitor. Once dry, the asbestos sleeves hold their shape.—*Peter Legon*

## BATTERY HOLDER

In many experiments there isn't enough room for a regular battery holder. The battery must be soldered directly into the circuit. On a single cell, the negative (zinc) terminal is easily sold-

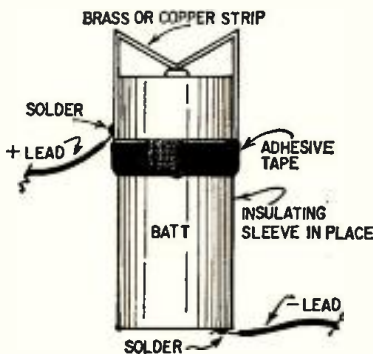

ered, but the positive connection quickly pulls loose.

Bend a brass or copper strip into an M shape and fit it down around the battery. Solder a piece of hookup wire to the strip. Pull the strip down tight against the battery (with the cardboard sleeve in place, of course) and tape the strip in place. The negative lead can be soldered directly to the zinc case.—*David Mark*

## GUN SOLDER POT

This little solder pot is grand for soldering phone tips and tinning wire ends. It heats up fast in your soldering gun. Take an inch-long brass flanged

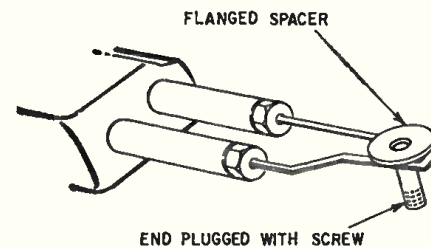

spacer and plug its end with a short set-screw. Hold the pot in the gun's tip by bending the tip inward. Drop earphone or instrument tips in the pot for soldering.—*L. Peters*

# "MOVING-IN PARTY" YOU—HELPED US BUILD A BIG INVENTORY! THESE AMAZING BUYS—ARE YOUR DIVIDENDS

**FREE \$1 BUY WITH EVERY 10 YOU ORDER** Only applies to "\$1" Buys **FREE GIFT WITH EVERY ORDER**

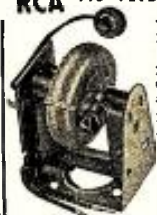
- |   |  |   |  |
|---|--|---|--|
| <ul style="list-style-type: none"> <li><input type="checkbox"/> 3—TOP HAT SILICON RECTIFIERS 750ma-600v top quality .. \$1</li> <li><input type="checkbox"/> 100—MIXED DEAL "JACKPOT" Condensers, Resistors, Surprises .. \$1</li> <li><input type="checkbox"/> \$15.00 RADIO PARTS "JACKPOT" handy assortment .. \$1</li> <li><input type="checkbox"/> 1—SQ. YARD GRILLE CLOTH most popular brown &amp; gold design \$1</li> <li><input type="checkbox"/> 25—INSTRUMENT POINTER KNOBS selected popular types .. \$1</li> <li><input type="checkbox"/> 20—ASST. PILOT LIGHTS #44, 46, 47, 51, etc. .... \$1</li> <li><input type="checkbox"/> 50—ASST. DISC CERAMIC CONDENSERS popular numbers .. \$1</li> <li><input type="checkbox"/> 3—ELECTROLYTIC CONDENSERS 50/30-150v .. \$1</li> <li><input type="checkbox"/> 10—ASST. RADIO ELECTROLYTIC CONDENSERS .. \$1</li> <li><input type="checkbox"/> 50—ASST. TUBULAR CONDENSERS .001 to .47 to 600v .. \$1</li> <li><input type="checkbox"/> 20—STANDARD TUBULAR CONDENSERS .047-600v .. \$1</li> <li><input type="checkbox"/> 20—BENDIX CONDENSERS .007-2000v \$15 value .. \$1</li> <li><input type="checkbox"/> 3-1/2 MEG VOLUME CONTROLS with switch, 3" shaft \$1</li> <li><input type="checkbox"/> 5—ASST. 4 WATT WIRE-WOUND CONTROLS .. \$1</li> </ul> | <ul style="list-style-type: none"> <li><input type="checkbox"/> BONANZA "JACKPOT" not gold, not oil, but a wealth of Electronic Items—Money-Back-guarantee .... \$5</li> <li><input type="checkbox"/> 75'—MINIATURE ZIP CORD \$1</li> <li><input type="checkbox"/> 10—ASSORTED SLIDE SWITCHES SPST, SPDT, DPDT, etc. .... \$1</li> <li><input type="checkbox"/> 10 SETS — DELUXE PLUGS &amp; JACKS nast. for many purposes .. \$1</li> <li><input type="checkbox"/> 10 — SETS PHONO PLUGS &amp; PIN JACKS RCA type .. \$1</li> <li><input type="checkbox"/> 10 — SURE-GRIP ALLIGATOR CLIPS 2" plated .. \$1</li> <li><input type="checkbox"/> 4—50' SPOOLS HOOK-UP WIRE 4 different colors .. \$1</li> <li><input type="checkbox"/> 50—RADIO &amp; TV SOCKETS all type 7 pin, 8 pin, 9 pin, etc. \$1</li> <li><input type="checkbox"/> 200'—BUSS WIRE #20 tinned for hookups, special circuits, etc. .. \$1</li> <li><input type="checkbox"/> 100—STRIPS ASSORTED SPAGHETTI handy sizes .. \$1</li> <li><input type="checkbox"/> 100—ASSORTED RUBBER GROMMETS best sizes .. \$1</li> <li><input type="checkbox"/> 50—ASSORTED PRINTED CIRCUIT SOCKETS best types .... \$1</li> <li><input type="checkbox"/> 20—ASSORTED VOLUME CONTROLS less switch .. \$1</li> <li><input type="checkbox"/> 7—ASSORTED VOLUME CONTROLS with switch .. \$1</li> <li><input type="checkbox"/> 5—ASST. SELENIUM RECTIFIERS 65ma, 100ma, 300ma, etc. \$1</li> </ul> | <div style="border: 1px solid black; padding: 5px;"> <p><b>RCA 110° FLYBACK TRANSFORMER</b></p>  <p>We scooped the Market Latest type — standard for all 110° TV's<br/>RCA's design of large Coil produces 18KV—assuring adequate width I.F. video, sound, ratio, etc. ....<br/>Incl Schematic Diagram application for any TV<br/>List price \$13.90<br/>Your price .. \$3<br/>10% off in lots of 3</p> </div> <ul style="list-style-type: none"> <li><input type="checkbox"/> 4—TV ALIGNMENT TOOLS most useful assortment .. \$1</li> <li><input type="checkbox"/> 90° FLYBACK TRANSFORMER for all type TV's incl schematic \$1</li> <li><input type="checkbox"/> 70° FLYBACK TRANSFORMER for all type TV's incl schematic \$1</li> <li><input type="checkbox"/> 70° TV DEFLECTION YOKE for all type TV's incl schematic \$1</li> <li><input type="checkbox"/> 20—ASSORTED TV COILS I.F. video, sound, ratio, etc. .... \$1</li> <li><input type="checkbox"/> 40—ASSORTED TV KNOBS all standard types, \$20 value .. \$1</li> <li><input type="checkbox"/> 20—ASSORTED GRID CAPS for 1B3, 1X2, 6BQ6, 6BQ6, etc. .. \$1</li> <li><input type="checkbox"/> 100—ASSORTED TV PEAKING COILS all popular types .. \$1</li> <li><input type="checkbox"/> 2—TV VERT OUTPUT TRANS universal 10:1 ratio for all TV's .. \$1</li> <li><input type="checkbox"/> 20—EXPERIMENTER'S COIL "JACKPOT" assorted for 101 uses \$1</li> </ul> | <ul style="list-style-type: none"> <li><input type="checkbox"/> 10—G.E. SAPPHIRE NEEDLES 4G, VR-11, etc. (\$25.00 value) .. \$1</li> <li><input type="checkbox"/> 50—G.E. FLASHLIGHT BULBS #PR-0, 2.7 volts .. \$1</li> <li><input type="checkbox"/> 15—G.E. #NE-2 TUBES Neon Glow Lamp for 101 uses .. \$1</li> <li><input type="checkbox"/> 2—G.E. PIECES OF EQUIPMENT stacked with over 200 useful parts \$1</li> <li><input type="checkbox"/> 20—ITT SELENIUM RECTIFIERS 65ma for Radios, Meters, Chargers, Translators, Experiments, etc. .... \$1</li> <li><input type="checkbox"/> 7—ASST. TV ELECTROLYTIC CONDENSERS popular selection .. \$1</li> <li><input type="checkbox"/> \$15.00 TELEVISION PARTS "JACKPOT" best buy ever .... \$1</li> <li><input type="checkbox"/> 1—LB SPOOL ROSIN-CORE SOLDER 40/60 top quality .... \$1</li> <li><input type="checkbox"/> 10—ASSORTED DIODE CRYSTALS 1N34, 1N48, 1N60, 1N64, 1N82 \$1</li> <li><input type="checkbox"/> 10—TOP BRAND TRANSISTORS NPN &amp; PNP 2N404, 2N414, etc. \$1</li> <li><input type="checkbox"/> CLEAN UP THE KITCHEN" JACKPOT" Big Deal only one to a customer .. \$1</li> <li><input type="checkbox"/> 5—ASSORTED TRANSFORMERS Radio, TV and Industrial .. \$1</li> </ul> |
|---|--|---|--|

**IMMEDIATE DELIVERY** ... Scientific light packing for safe delivery at minimum cost. **HANDY WAY TO ORDER:** Pencil mark or write amounts wanted in each box, place letter F in box for Free \$1 BUY. Enclose with check or money order, add extra for shipping. Tearsheets will be returned as packing slips in your order, plus lists of new offers.

Name .....

Address .....

Cost of goods .....

Shipping estimated .....

TOTAL .....

Please specify refund on shipping overpayment desired:  CHECK  POSTAGE STAMPS  MERCHANDISE (our choice) with advantage to customer



**REVERSING AC MOTORS**  
 Many experimenters have had difficulty in reversing the direction of rotation of small induction motors like those used on the side of the motor. Put the shaft on the motor sockets. Take the screws out of the motor. — Steve



**LOW-COST COIL FORMS**

Go to the dime store and pick up a package of plastic hair rollers and you have some cheap coil forms. The little plastic slots will keep the wire separated and spaced for short-wave or

high-frequency coils. If you want the coil close-wound, break off the little plastic pieces. These rollers come in various sizes and make good low-loss, low-cost coil forms for your next short-wave project.—L. D. Held

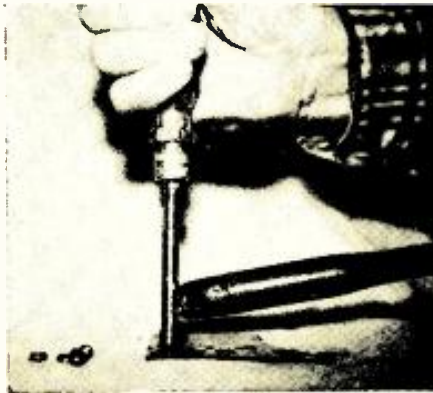

**PLASTIC NUTS**

No shorts across printed circuits, no detuning, with plastic nuts. Pressing a heated socket wrench (nut driver) through a 1/8-inch piece of acrylic or polystyrene plastic does the trick. Don't move the wrench as it goes through, but lift the plastic after the wrench sinks through.

Drill and tap the hardened nut in the wrench. Insert the screw and pull out your plastic nut. Quick-drying cement locks it.—Peter Legon

**NEW! QUIETROLE'S BIG THREE AEROSOLS**  
 For Electronic Servicing

**HARMLESS TO PLASTICS!**

**MARK-II For Tuners**

**SPRAY-PACK For Controls & Switches**

**SILITRON For General Use**

Zero effects on capacity and resistance. Non-inflammable... non-conductive... non-corrosive. All include free five-inch plastic extender. Yes! Quietrole is still available in bottles with an eye dropper!

manufactured by **QUIETROLE COMPANY**  
 Spartanburg, South Carolina

Circle 37 on reader's service card

**CANADIANS: Ordering is easy . . . we do the paperwork . . . try a small order**

**SARKES TARZIAN TV TUNER 41mc**

Latest Compact Model—good for all 41 mc TV's.  
**BRAND NEW—MONEY BACK GUARANTEE**

Best TUNER "SARKES TARZIAN" ever made—last word for stability, definition & smoothness of operation. An opportunity—to improve and bring your TV Receiver up-to-date.

**COMPLETE with Tubes & Schematic . . . \$7.95**

**HIGHWAVE AM-FM PORTABLE RADIO**

Elegance in Ebony & Chrome  
 14 Transistors - A Powerhouse of Quality Reception with AFC  
 Operates on 4 "C" Cells  
 22" Telescoping FM Antenna & Personal Listening attachment  
 Money refund - If not better than any Known Brand selling for even twice the price  
 8"x5 1/4"x2 1/4" - 4 lbs

**COMPLETE . . . \$19.50**

**IBM COMPUTER SECTIONS**

8 assorted Units we sell for \$1 are loaded with over 150 valuable parts.

Incl. — Transistors, Condensers, Resistors, Heat Sinks, Diodes, Etc.

**8 for \$1**  
**100 for \$10**

**12 HARDWARE GOODIES**

- 1000—ASST. HARDWARE KIT \$1  
screws, nuts, washers, rivets, etc.
- 300—ASSORTED HEX NUTS \$1  
2/56, 4/40, 5/40, 6/32, 8/32
- 250—ASST. SOLDERING LUGS \$1  
best types and sizes
- 250—ASST. WOOD SCREWS \$1  
finest popular selection
- 250—ASST. SELF TAPPING SCREWS \$1  
#0, #8, etc.
- 150—ASST. 2/56 SCREWS and 150 6/32 HEX NUTS \$1
- 150—ASST. 8/32 SCREWS and 150-8/32 HEX NUTS \$1
- 150—ASST. 2/56 SCREWS and 150-2/56 HEX NUTS \$1
- 150—ASST. 4/40 SCREWS and 150-4/40 HEX NUTS \$1
- 150—ASST. 5/40 SCREWS and 150-5/40 HEX NUTS \$1
- 500—ASSORTED RIVETS \$1  
most useful selected sizes
- 500—ASSORTED WASHERS \$1  
most useful selected sizes

- HEARING AID AMPLIFIER \$2  
incl. 3 Tubes, Mike, etc. (as is)
- UNIVERSAL 2" PM SPEAKER \$2.95  
Ainco 5 magnet, quality tone
- UNIV. 3" x 5" PM SPEAKER \$7.50  
Best type for Radios, TV, Etc.
- UNIVERSAL 4" PM SPEAKER \$6.95  
Ainco 5 magnet, Quality tone
- 3—AUDIO OUTPUT TRANSFORMERS \$1  
50L6 type
- 10—SPEAKER PLUG SETS \$1  
deluxe type, 2 conductor
- CHAPT ZU DI MITZIA "JACK-POT" double your money back if not completely satisfied \$1
- 300—ASST. 1/2 W RESISTORS \$1  
Top Brand, Short leads, excellent
- 100—ASST. RUBBER & FELT FEET FOR CABINETS \$1  
best sizes
- 5—I.F. COIL TRANSFORMERS \$1  
sub-min for Transistor Radios
- 5—AUDIO OUTPUT TRANSFORMERS \$1  
Sub-min for Trans Radios
- 4—TOGGLE SWITCHES \$1  
SPST, SPDT, DPST, DPDT
- 15—ASST. ROTARY SWITCHES \$1  
all popular types \$20 value

- 100—ASST. CERAMIC CONDENSERS \$1  
Some in 5%
- 100—ASST. MICA CONDENSERS \$1  
Some in 5%
- 100—ASST 1/4 WATT RESISTORS \$1  
stand. choice ohmages, some in 5%
- 100—ASST 1/2 WATT RESISTORS \$1  
stand. choice ohmages, some in 5%
- 70—ASST 1 WATT RESISTORS \$1  
stand. choice ohmages, some in 5%
- 35—ASST 2 WATT RESISTORS \$1  
stand. choice ohmages, some in 5%
- 50—PRECISION RESISTORS \$1  
asst. list-price \$50 less 98%
- 20—ASST'ED WIREWOUND RESISTORS, 5, 10, 20 watt \$1
- 50—ASST. TERMINAL STRIPS \$1  
all types, 1-jug to 6-jug
- 25—INSTRUMENT POINTER KNOBS \$1  
selected popular types
- 50—ASST. RADIO KNOBS \$1  
all selected popular types
- 5—PNP TRANSISTORS \$1  
general purpose, TO-5 case
- 5—NPN TRANSISTORS \$1  
general purpose, TO-5 case
- 2—POWER TRANSISTORS No. 1 \$1  
Replace 2N155, 2N176, 2N301, etc.
- 10—ASST DUAL CONTROLS \$1  
for Radio, TV, Hi-Fi, Stereo, etc.

- 50—ASSORTED MYLAR CONDENSERS \$1  
popular selected types
- TELEPHONE JACK or PLUG \$1  
make any telephone portable
- TELEPHONE RECORDING DEVICE \$1  
Place it under telephone
- CRYSTAL LABEL MICROPHONE \$1  
high impedance, 200-6000 cps
- 25'—MICROPHONE CABLE \$1  
deluxe, 2 conductor, shielded
- TAPE RECORDER—assorted types \$4  
good, ind. broken, as-is, potluck
- TRANSISTOR RADIO \$1.50  
good, bad, broken, as-is, potluck
- 4—TRANSISTOR RADIO EARPIECES \$1  
wired complete with plug
- \$15.00 RADIO PARTS "JACK-POT" \$1  
handy assortment
- RAYTHEON 6BG6 TUBE \$1  
brand new, list price \$6.50
- 10—ASSORTED TUBES \$1  
Radio, Television and Industrial
- ALL AMERICAN TUBE KIT \$2  
Top Standard Brand—12BA6, 12RE6, 12AV6, 50C5, 65W4
- 5—RCA 1U4 TUBES brand new \$1  
boxed, also serves as a 1T4

**BROOKS RADIO & TV CORP., 487 Columbus Ave., New York, N. Y. 10024**

TELEPHONE 212-874 5600

The following free advertising material is available through

## RADIO-ELECTRONICS READER'S SERVICE

<b>AEROVOX CORP.</b> (Pg. 24) Aerovox Servicemen's Catalog No. SE-565 on exact replacement twist prong AFH electrolytics.	Circle 21
<b>ALLIED RADIO CORP.</b> (Pg. 82) Catalog.	Circle 108
<b>AMPEREX</b> (Second Cover) List of replacement tubes.	Circle 7
<b>B &amp; K MANUFACTURING CO.</b> (Third Cover) Catalog AP-22-R with description of B & K Model 970 Radio Analyst.	Circle 149
<b>BRACH MFG. CORP.</b> (Pg. 87) Catalog with complete line of antennas.	Circle 115
<b>BROOKS RADIO &amp; TV CORP.</b> (Pg. 76-77) Information sheets and price lists of tubes and parts.	Circle 38
<b>CASTLE TV TUNER SERVICE</b> (Pg. 65) Information on complete tuner overhaul by mail.	Circle 30
<b>CLEVELAND INSTITUTE OF ELECTRONICS</b> (Pg. 20) Brochure on Electronics Slide Rule with Instruction Course and pocket-size Electronics Data Guide.	Circle 18
<b>CORNELL ELECTRONICS CO.</b> (Pg. 94) Catalog and price list of tubes and parts.	Circle 124
<b>COYNE ELECTRONICS INSTITUTE</b> (Pg. 91) Book: "Your opportunities in Electronics."	Circle 122
<b>CRAIG PANORAMA, INC.</b> (Pg. 70) Name of nearest distributor of Craig 4-track, dual-head Car-Stereo line.	Circle 32
<b>DELTA PRODUCTS INC.</b> (Pg. 24) Literature and complete technical data on Mark Ten SCR capacitive discharge ignition system.	Circle 22
<b>DE VRY TECHNICAL INSTITUTE</b> (Pg. 5) Free booklets, "Pocket Guide to Real Earnings," and "Electronics in Space Travel."	Circle 9
<b>EASTMAN KODAK COMPANY</b> (Pg. 9) "Plain Talk" booklet on major aspects of tape performance.	Circle 12
<b>FINNEY CO.</b> (Pg. 65) Brochure No. 20-349 on Finco-Axial Color-Kit.	Circle 31
<b>FINNEY CO.</b> (Pg. 87) Brochure No. 20-338 on Finco Booster-Coupler.	Circle 114
<b>GRANTHAM SCHOOL OF ELECTRONICS</b> (Pg. 91) Brochure on FCC license preparation.	Circle 121
<b>HALLICRAFTERS CO.</b> (Pg. 18) Information on Hallicrafter's CB-19 transceiver.	Circle 16
<b>HEALD'S ENGINEERING COLLEGE</b> (Pg. 89) Catalog and registration application.	Circle 118
<b>HEATH COMPANY</b> (Pg. 11) Catalog and specifications on Heathkit 10-14, Professional DC 'Scope.	Circle 13
<b>HEATH COMPANY</b> (Pg. 25) Catalog with details and specifications on Heathkit AR-14 30-watt solid-state FM/FM stereo receiver and AR-13A 66-watt solid-state AM/FM/FM stereo receiver.	Circle 23
<b>INTERNATIONAL CRYSTAL MFG. CO.</b> (Pg. 96) Information on International Model MD-23 Citizen's Radio Transceiver.	Circle 148
<b>INTERNATIONAL RADIO EXCHANGE</b> (Pg. 22) List of equipment in stock.	Circle 11
<b>INTERNATIONAL TV CORP.</b> (Pg. 90) Information on 8 pole, 1/4-track, stereo "combo" tape head.	Circle 120
<b>JUDSON RESEARCH &amp; MFG. CO.</b> (Pg. 83) Literature on electronic ignition system.	Circle 110
<b>LAMPKIN</b> (Pg. 86) Booklet ("How to Make Money in Mobile Maintenance") and information on Lampkin meters.	Circle 113
<b>MARANTZ, INC.</b> (Subsidiary of Superscope, Inc.) (Pg. 21) Information on the easy finance plan for owning a Marantz stereo system.	Circle 24
<b>MERCURY ELECTRONICS CORP.</b> (Pg. 72) Catalog on Mercury Model 1700, Vacuum Tube Voltmeter and Model 1800, Volt-Dhm Milliammeter.	Circle 34
<b>MUSIC ASSOCIATED</b> (Pg. 82) Information on Music Associated's Sub Carrier Detector for "music only" programs on FM Broadcast Band.	Circle 107
<b>PERMA-POWER COMPANY</b> (Pg. 23) Information on Perma-Power Color-Brite Model C-501 for brightening round color TV tubes and Model C-511 for brightening rectangular TV tubes.	Circle 20

Here's how you can get literature fast:

1. Tear out the post card on page. Clearly print or type your name and address.
2. Circle the number on the card that corresponds to the number appearing at the bottom of the New Products, New Literature or Equipment Report listing in which you are interested. For literature on products advertised in this issue circle the number on the card that corresponds to the number appearing at the bottom of the advertisement in which you are interested, or use the convenient checking list in the column at the left.
3. Mail the card to us (no postage required in U. S. A.)

<b>POLY PAKS</b> (Pg. 95) Information on semiconductors.	Circle 125
<b>PYRAMID ASSOC., INC.</b> (Pg. 74) List of tubes.	Circle 35
<b>QUAM-NICHOLS CO.</b> (Pg. 81) Information on color TV replacement speakers.	Circle 106
<b>QUIETROLE CO.</b> (Pg. 77) Information on lubricant and cleaner for tuners, controls, switches and general use.	Circle 37
<b>RCA INSTITUTES</b> (Pg. 63) Home Study Career Catalog.	Circle 28
<b>RADAR DEVICES MFG. CORP.</b> (Pg. 1) Information on how to have a business of your own distributing Radar Sentry Alarm Systems.	Circle 8
<b>SAMS, HOWARD W. &amp; CO., INC.</b> (Pg. 64) Booklist.	Circle 29
<b>SAMS, HOWARD W. &amp; CO., INC.</b> (Pg. 84) Information on Photofact-of-the-Month.	Circle 111
<b>H. H. SCOTT, INC.</b> (Pg. 8) Information on Scott LT-112 solid-state FM Stereo tuner kit.	Circle 19
<b>SHURE BROTHERS, INC.</b> (Pg. 19) Information on Shure High Fidelity Phono Cartridges.	Circle 17
<b>SENCORE</b> (Pg. 75) Descriptive literature on Sencore's MX129 FM stereo multiplex generator and analyzer.	Circle 36
<b>SPRAGUE PRODUCTS CO.</b> (Pg. 16) Catalog C-616 on Difilm Orange Drop Dipped Tubular Capacitors and Difilm Black Beauty Molded Tubular Capacitors.	Circle 14
<b>TEXAS CRYSTALS</b> (Pg. 83) Catalog.	Circle 109
<b>UNITED RADIO CO.</b> (Pg. 93) Tube catalog.	Circle 123
<b>UNIVERSITY SOUND</b> (Pg. 85) "The Lively Sound" catalog.	Circle 112
<b>WARREN ELECTRONIC COMPONENTS</b> (Pg. 90) Information on silicon rectifiers.	Circle 119
<b>WINEGARD CO.</b> (Pg. 89) Fact-finder #242 with information on Chroma-Tel antenna.	Circle 117

# **MAIL THIS CARD**

---

for free additional information on  
**PRODUCTS or SERVICES** featured in

# **Radio-Electronics**

**Here's how you can get additional information from the manufacturer, promptly and at no charge, concerning products and services advertised or mentioned editorially in this issue.**

**Circle the number on the attached postcard that corresponds to the number at the bottom of each advertisement or editorial mention that interests you.**

**Cut out the postcard. Clearly print or type your name and address where indicated — and mail. (Canadian and foreign affix postage.)**

**VOID AFTER AUGUST 31, 1966**

# NEW PRODUCTS

More information on new products is available free from the manufacturers of items identified by a Reader's Service number. Turn to the Reader's Service Card facing page 78 and circle the numbers of the new products on which you would like further information. Detach and mail the postage-paid card.

Hz = Hertz = cycle per second; kHz = kilocycles; MHz = megacycles



**PORTABLE TELEPHONE SYSTEM**, the *Stanafone*. Self-contained units. Transformers, controls, buzzers, batteries all contained in handle. 2 to 8 can be used in system. Clear speech over distances to 20 miles.—Billther Enterprises Inc.

Circle 46 on reader's service card

**SILICON RECTIFIER ASSORTMENT**, the *HANDYLab* kit, contains 13 silicon rectifier types, 8 types of molded full-wave rectifier bridges. Rectifier cur-



rent ratings range from 0.25 to 35 amperes with voltage ratings from 200 to 3,000. Altogether, 84 devices.—Motorola Semiconductor Products Inc.

Circle 47 on reader's service card

**EDUCATIONAL HEADPHONE**, Brush *ED-150*. Frequency response: 80-4,000 Hz. Sensitivity: 104 dB sound pres-



JULY, 1966

sure level  $\pm 4$  dB at 1 kHz with 1 mW input (0 dB = .0002 dyne/cm<sup>2</sup>). Impedance: 600 ohms at 1,000 Hz. 10 oz. with cushions. Molded plastic cord with phone plug.—Piezoelectric Div., Clevite Corp.

Circle 48 on reader's service card

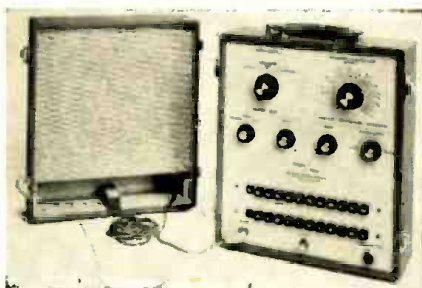

**PORTABLE MUSIC LABORATORY**, the *Magna-Tuner* (electronic tuner-metronome), can sound any interval from a minor second to an octave for ear training and testing pitch sensitivity. Has 156 fixed tones and 144 intervals, selected by pushbuttons. Metronome can be used alone or simultaneously with any of single tones; tone and metronome signals can be remotely controlled with foot or hand switches with a special output. External speaker built into cover. Amplifier jack. 7½ x 11 x 12½ in., less than 15 lb.—H. & A. Selmer, Inc.

Circle 49 on reader's service card

**SOLID-STATE CB TRANSCEIVER**, model *CB-20*, 5 channels. Sensitivity less than 1  $\mu$ V for 10 dB signal-to-noise ratio. Output power minimum 3 watts,



high modulation capability. 12 transistors, 8 diodes, 1 Zener regulator. 7 x 6 x 2½ in., 4 lb.—Hallicrafters Co.

Circle 50 on reader's service card

**TAPE RECORDER/REPRODUCER**, the *Maestro*, uses 2 capstan drives to carry tape. Starting time less than .01 second, stopping time equal to ½ inch of tape at 7½ ips—enables user to split a recorded eighth-note. Over 30-minute span of tape, initial and second runs coincide within  $\pm 2.0$  seconds. Input impedance: 100,000 ohms unbalanced bridging; 600 ohms balanced; 150-250-ohm microphone. Re-

brand new  
...and very important...  
**QUAM COLOR TV  
REPLACEMENT  
SPEAKERS PREVENT  
COLOR PICTURE  
DISTORTION**

OFTEN CAUSED BY STRAY  
MAGNETIC FIELDS FROM  
ORDINARY LOUSPEAKERS



When you use an ordinary loudspeaker in a color TV set, you're looking for trouble... picture trouble. The external magnetic fields from standard loudspeakers will deflect the primary color beams, causing poor registration and distorted pictures.

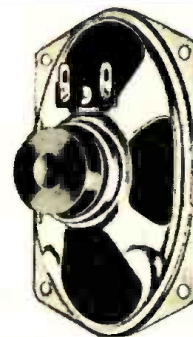

## QUAM RESEARCH SOLVES THIS PROBLEM

An entirely new construction technique, developed in the Quam laboratories, encases the magnet in steel, eliminating the possibility of stray magnetic fields and the problems they cause! These new Quam speakers have been eagerly adopted by leading color TV set manufacturers. Quam now takes pride in making them available for your replacement use. Five sizes (3" x 5", 4", 4" x 6", 5¼", 8")... in stock at your distributor.

# QUAM

QUAM-NICHOLS COMPANY

234 E. Marquette Rd. • Chicago, Ill. 60637

Circle 106 on reader's service card

Enjoy the "music-only" programs now available on the FM broadcast band from coast to coast.

- NO COMMERCIALS •
- NO INTERRUPTIONS •



It's easy! Just plug Music Associated's Sub Carrier Detector into multiplex jack of your FM tuner or easily wire into discriminator. Tune through your FM dial and hear programs of continuous commercial-free music you are now missing. The Detector, self-powered and with electronic mute for quieting between selections, permits reception of popular background music programs no longer sent by wire but transmitted as hidden programs on the FM broadcast band from coast to coast. Use with any FM tuner. Size: 5½" x 6". Shipping weight approx. 7 lbs.

**KIT \$49.50**

(with pre-tuned coils, no alignment necessary)

**WIRED \$75.00** (Covers extra \$4.95 ea.)

Current list of FM Broadcast stations with SCA authorization \$1.00

**MUSIC ASSOCIATED**

65 Glenwood Road, Upper Montclair, N. J.  
Phone: (201)-744-3387

Circle 107 on reader's service card

## FAMOUS WALKIE-TALKIE KNIGHT KIT®



**\$5.88** each Postpaid

Buy a pair for two-way fun.

- Tens of thousands sold at \$8.88 each!
- No license needed; operates hours on one battery.
- Complete with Ch. 7 transmit crystal.
- Fun to build yourself.

Even Allied has never before offered such value in a walkie-talkie kit! Sends and receives messages up to ¼ mile with 3-transistor circuit. Takes just a few hours to assemble. Sensitive super-regenerative receiver, push-to-talk transmitter. Telescoping antenna. Blue case 5½ x 2½ x 1¾". Add 27c for each battery.

- Use coupon below to order your kit now.
- Check box to receive latest Allied catalog.

Allied Radio, Dept. 2G  
100 N. Western Avenue  
Chicago, Ill. 60680  Yes, send new free catalog!

Please send me.....Knight walkie-talkie kits (83 PA 804 RPW). I enclose \$5.88 for each unit. Also send \_\_\_\_\_ batteries (83 PA 005 RPW). I enclose 27c for each battery. Satisfaction guaranteed or money back.

NAME \_\_\_\_\_ (please print)

ADDRESS \_\_\_\_\_

CITY, STATE \_\_\_\_\_ ZIP \_\_\_\_\_

Circle 108 on reader's service card



response: ±1 dB from 50-15,000 Hz at 7½ ips; ±1 dB from 50-7,500 Hz at 3½ ips. Signal-to-noise ratio -55 dB unweighted, -65 dB weighted. Wow and flutter: .09% at 7½, 0.125% at 3½. Power, 2 amps at 117 Vac, 60 Hz. 15½ x 19 x 8 in.—Tape-Athon Corp.

Circle 51 on reader's service card

HEARING AID, the Director, weighs less than ½ oz. Front and rear microphone port openings permit "circle of sound" reception. Integrated circuit so



small that 35,000 complete circuits, before encapsulation, could be stacked in 1 cubic inch.—Zenith Hearing Aid Sales Corp.

Circle 52 on reader's service card



COLOR CRT TEST-SOCKET ADAPTER, model 2380, simplifies servicing color CRT's with miniature diheptal bases. Installed between CR tube and socket, permits voltage, resistance, video,

other measurements at tube base. Extended test-tab contact points for alligator clips or test prods. Accepts tube bases equipped with spark gaps.—Pomona Electronics Co., Inc.

Circle 53 on reader's service card

2-BAND TUNABLE FM COMMUNICATIONS RECEIVER, model HA-520. Tunes 30-50 and 152-174 MHz with sensitivity of 3 µV for 20-dB quieting. Tuned rf amplifier on both bands; Nuistor on 152-174-MHz band. 4-inch PM speaker



with 1.2 watts audio output, front-panel 8-ohm headphone jack. Transformer power supply with full-wave silicon-diode rectification. Power: 47 watts at 117 volts 50-60 Hz. 11½ x 5½ x 7½ in.—Lafayette Radio Electronics Corp.

Circle 54 on reader's service card

MOBILE ANTENNA, the Hustler TCS-27-M for CB operation and AM and FM reception. Combines slim telescopic antenna and ZM-60 matching harness which attaches to car radio and CB transceiver without switching devices. ZM-60 pairs 60 inches of 52Ω coax and 60 inches of high-impedance auto antenna lead with matching

device performing as diplexer. Chrome-plated seamless brass tubing telescopes from 37 to 53 in.—New-Tronics Corp.

Circle 55 on reader's service card

MAGNETIC TAPE BULK ERASERS, Ferranti-Weircliffe models 6, 7, 8 erase saturated tapes at rate of 100 to 250



reels per hour. All recorded data, audio pulses, any signal from dc to video efficiently erased to better than 80 dB below saturation recording level. Model 6 handles reels up to 8½-in. dia. with tapes up to 1 in. wide. Model 7 for tape cartridges up to 8 in. square. Model 8 take reels up to 14½ in. with tape to 2 in. wide. Mahogany case.—Ferranti Electric, Inc.

Circle 56 on reader's service card

RADIO-ELECTRONICS

**FM TWO-WAY RADIO, the Motran.** Intermodulation rejection increased to 80 dB from 65. Receiver picks up signals as weak as 0.35  $\mu$ V; optional rf preamp improves sensitivity to 0.175  $\mu$ V. Receiver



distortion 5%. Stability guaranteed over temperature range from  $-35^{\circ}\text{C}$  to  $+70^{\circ}\text{C}$ . Internal noise (FM)  $-75$  dB. Output 30 watts rf power. Battery drain 8.7 amps transmitting.—Motorola Communications Div.

Circle 57 on reader's service card



**AM/FM STEREO TUNER, LT-325A.** Tuner sensitivity: 2  $\mu$ V for 20-dB signal-to-noise ratio. Response 15–15,000 Hz  $\pm 1$  dB; channel separation better than 38 dB at 400 Hz. Variable afc and multiplex noise filter. Built-in ferrite loop antenna for AM; 300 $\Omega$  FM antenna input. 14 $\frac{1}{2}$  x 5 $\frac{1}{2}$  x 9 $\frac{1}{2}$  in.—Lafayette Radio Electronics Corp.

Circle 58 on reader's service card

**STEREO AMPLIFIER, model AM-278.** Separate volume controls for each channel, ganged tone control. Brushed aluminum panel. Power output 5 watts



(2 $\frac{1}{2}$  per channel). Response 60–15,000 Hz. 8-ohm outputs. Inputs: high-impedance crystal or ceramic cartridge. 7 x 5 x 3 $\frac{1}{2}$  in.—Olson Electronics, Inc.

Circle 59 on reader's service card

**ELECTRONIC ORGAN KIT, model GD-325.** Kit version of Thomas Color-610 organ. Keys light up with color codes for melody; harmony, following Thomas Color-Glo music book (included). Foot pedals marked with same colors as harmony notes. Features 10 organ voices; variable repeat percussion for banjo, man-



dolin, balalaika effects; 13-note heel and toe bass pedals; 2 overhanging 37-note keyboards; 12-in. speaker; 50-watt EIA peak music power amplifier; 2 levels of vibrato intensity; manual balance control; variable expression pedal; variable bass-pedal volume; handrubbed walnut cabinet. Transistor plug-in tone generators warranted for 5 years. Construction time about 50 hours.—Heath Co.

Circle 60 on reader's service card



**REMOTE-CONTROL UNIT, MWA-15-1,** provides complete remote control for Heath MWW-15 8-channel 150-watt radiotelephone. Controls channel switching, power on-off, volume, squelch, selection of remote's internal speaker, external monitor, and handset. Styled to match MWW-15, is 5 x 9 x 4 $\frac{1}{2}$  in.—Heath Co.

Circle 61 on reader's service card

**HOME-AUTO TESTER, model TE-201,** checks electrical circuits in home or



**CRYSTALS are not all the same!**



If your dealer is temporarily out of stock or does not carry Texas Crystals, send us his name along with your request for catalog to our plant nearest you.

**Texas Crystals quality is outstanding** as evidenced by use in numerous government space projects where there's no compromise with quality, reliability or accuracy. The same dependable performance is yours for CB operation on all 23 channels at only \$2.95 per crystal.

Send for Free Catalog with Circuits  
**TEXAS CRYSTALS**  
 A Division of Whitehall Electronics Corp.  
 1000 Crystal Drive Fort Myers, Florida 4117 W. Jefferson Blvd. Los Angeles, California  
 Phone 813 WE 6-2109 Phone 213 731-2258  
 Circle 109 on reader's service card

**WE DON'T CLAIM  
 OUR ELECTRONIC  
 IGNITION SYSTEM  
 IS BEST**



**OUR CUSTOMERS DO!**  
 WRITE TODAY FOR FREE LITERATURE

**JUDSON**  
 RESEARCH AND MFG. CO.  
 CONSHOHOCKEN, PA, U.S.A.

Circle 110 on reader's service card

# NOW! SAVE OVER \$60 PER YEAR!

## JOIN THE NEW PHOTOFACT® OF-THE-MONTH CLUB!

Only \$10 per month brings you 20% more current monthly Photofact service data coverage to boost your daily earnings!



Keep up with current model production—get 6 new Photofact sets every month in handy new file folders sealed in factory carton to insure completeness—easy to file, easy to use. To stay ahead, to save money (individually purchased sets now sell for \$2.50 each)—join the Photofact-of-the-Month Club now!

SEE YOUR SAMS DISTRIBUTOR  
OR SEND ORDER FORM BELOW

**HOWARD W. SAMS & CO., INC. Dept. REF-7**  
4300 W. 62nd St., Indianapolis, Ind. 46206

Enroll me in the Photofact-of-the-Month Club. I agree to pay \$10 per month, and understand I will receive 6 current Photofact sets monthly to be delivered by my Sams Distributor (named below).

Name \_\_\_\_\_

Shop Name \_\_\_\_\_

Address \_\_\_\_\_

City \_\_\_\_\_ State \_\_\_\_\_ Zip \_\_\_\_\_

My Sams Distributor is: \_\_\_\_\_

Signed: \_\_\_\_\_

Circle 111 on reader's service card

auto. Multirange ac/dc voltmeter, ohmmeter, ammeter, wattage and leakage checker. Voltage ranges: 0-7.5-15-150-300. Current: 15 amps. Resistance: 0-1,000 ohms. Neon-lamp circuit-leakage test. With test leads and instructions.—Olson Electronics, Inc.

Circle 62 on reader's service card



**TV BALUN TRANSFORMER KITS, MT51 and MT55, coax-cable installations.** Kit includes outdoor transformer to match 300-ohm antenna to 72-ohm coax and, indoor transformer to match coax to set. JFD Electronics Corp.

Circle 63 on reader's service card



**COLOR GENERATOR, the CC10 Lo-Boy, solid-state, provides 5 basic patterns used in convergence; 10 standard RCA-type color bars, individual horizontal and vertical lines, crosshatch, adjustable-size white dots. Variable interlace control. Powered by C cells replaceable from outside of unit. Timing-circuit adjustments on front panel.—Sencore, Inc.**

Circle 64 on reader's service card

**TWIN-LINE SPLITTER/MIXER, model 1460B, splits single uhf-vhf twin line into two separate outputs. Uhf sig-**



nals are sent to uhf antenna inputs of the TV set and vhf signals are sent to vhf input.—Jerrold Electronics Corp.

Circle 65 on reader's service card

**SPEAKER, the SK-500 pneumatic air suspension, 12-inch, 3-way. Less than 1% distortion in 25-20,000-Hz audio**



range. Built-in 2,000- and 5,000-Hz crossover, high-frequency L-pad control, 1½-lb magnet. 1½-in. woofer voice-coil diameter; 1-in. tweeter. Free-air cone resonance 22-27 Hz. Rated impedance 8-16 ohms. Power handling, 30 watts.—Lafayette Radio Electronics Corp.

Circle 66 on reader's service card



**CB RADIO, the Companion III, solid-state, 6-channel plus PA. Comes with channel-9 crystals for use in Highway Emergency Locating Plan (HELP). Two rf stages in receiver; 2½ x 8½ x 6½ in., 3 lb.—Pearce-Simpson, Inc.**

Circle 67 on reader's service card

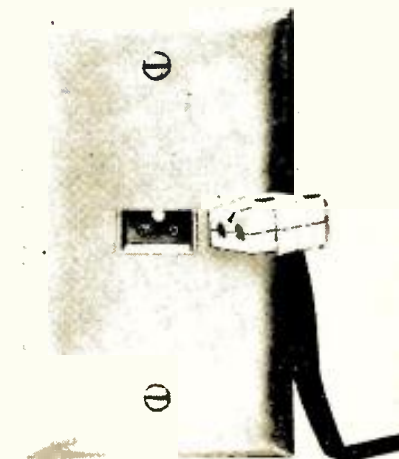

**TV/FM WALLPLATES. Incorporate Sta-Kleen design feature, available in 6 configurations: single and double gang, single and double gang with one duplex outlet, architectural face single gang and double gang with one duplex outlet. 5 colors.—Slater Electric Inc.**

Circle 68 on reader's service card

**MOBILE SELECTIVE-CALL SYSTEM, Encoder 290/Decoder 220, allows base-station transmitter to signal selec-**





tively any one of 90 mobile radios. Encoder: power, 117 Vac; 0-0.5 Vrms adjustable output into 600 ohms; 0.5-0.7-second timing each tone; 3.3-second cycle per call; frequency,  $\pm 0.15\%$  of design each tone; 90 separate codes each unit; 9 x 12 x 5 1/2 in., 9 lb., 10 oz. Decoder: impedance matches 3-20-ohm speaker circuit; input signal responds to 2-tone sequential signal from encoder; 1-5 Vrms dynamic operating range; horn-switch rating, 1 amp at 29 Vdc, resistive; input power 13.6 Vdc  $\pm 20\%$  (positive or negative ground); lockup current 120 mA horn switch off, 100 mA horn switch on; 0 mA standby current.—Bramco Controls Div., Ledex Inc.

Circle 69 on reader's service card

MULTIPROBE, MP-1, does work of dc, ac/ohms, rf and lo-cap probes. Uses vtvm, scope and signal tracer. Rotating head with detent action. Probe tip fits



standard alligator clips. Rf ground return for low loss. Fully shielded coaxial cable prevents stray pickup.—Mercury Electronics Corp.

Circle 70 on reader's service card

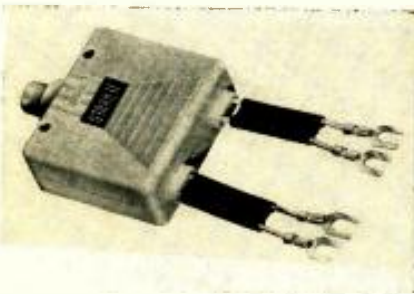

TRANSFORMER AND UHF/VHF SPLITTER, model T-380, matches 75 $\Omega$  coaxial cable to 300 $\Omega$  TV sets, splitting the signals and providing separate uhf and vhf 300 $\Omega$  inputs to the set.—Jerrold Electronics Corp.

Circle 71 on reader's service card



HI-FI ACCESSORY, the Phone-Mate, converts any standard low-impedance stereophonic headphone into high-impedance. Contains two shielded

JULY, 1966

output transformers. Available in 100-, 500-, 2,000- and 10,000-ohm impedances. 10,000-ohm impedance recommended for cathode follower circuits. 3/8-in. diameter by 3-in. barrel length.—R-Columbia Products Co. Inc.

Circle 72 on reader's service card

EXPLOSION PROOF DRIVER UNITS, HLE series, Underwriters' Laboratories approved, designed for paging, talk-back and warning signal applications where flammable dusts, liquids and gases are present. Provide conduit entrance re-



quired; have space for 70-volt line transformer. Power: 60 watts. Impedance: 16 ohms. Response: 70-12,000 Hz. Sound level: 123.5 to 128 dB, depending on horn used. 8 7/16-in. diameter, 8 1/16 in. long. Conduit entrance 1/2 in., 15 lb.—Atlas Sound

Circle 73 on reader's service card



The lively sound of the Mustang! The more-than-you-pay-for performance of University's newest and liveliest line of Mustang speakers. New slim line profile permits easy installation. Read the full story of the Mustang in University's newest catalog. You'll also receive our brand new 1966 catalog, "The Lively Sound." They're Free! Write today.

UNIVERSITY SOUND  
 Desk G69 Box 1056  
 Oklahoma City, Okla

Name .....

Address .....

City .....

State ..... Zip .....

Circle 112 on reader's service card

exactly  
 where do you  
 plan to go  
 in  
 electronics

?  
 PAGE 63 CAN HELP YOU MAP IT OUT.

**SAVE DOLLARS ON HIGH-PRECISION COMPONENTS**

Eye-opening advice on making up resistor and capacitor decades with a minimum of high-priced parts. Commercial precision decades usually use individual exact values for each step. It's now possible to get the same decade values with only four precision resistors or capacitors. See how it's done. Full schematics and tables of alternate combinations.

**All in AUGUST TEST INSTRUMENT SPECIAL ISSUE RADIO-ELECTRONICS**

**Earn Extra Income in MOBILE-RADIO MAINTENANCE!**



**CITIZENS BAND AIRCRAFT... MARINE... PUBLIC SAFETY... BUSINESS AND INDUSTRIAL RADIO**

**961,000 new transmitters added last year, with the curve still going upward!**

**MEASURE FREQUENCY with the LAMPKIN 105-B**

- Just this ONE instrument . . . with no extra crystals or factory adjustments . . . will measure ALL channels from 100 KC to 175 MC. Only \$295.00.
- Ample accuracy for all mobile transmitters except for split-channels above 50 MC—for these use inexpensive accessory PPM Meter.
- Pin-point signal generator for receiver final alignment.
- Internal quartz crystal standard . . . correctable to WWV.

**MEASURE FM DEVIATION with the LAMPKIN 205-A**

- Just this ONE meter measures all mobile channels, 25 MC to 500 MC.
- Reads instantaneous true peak swing due to FM modulation.
- Set selective-calling tone signals using 0-1.25 KC or 0-2.5 KC ranges of 205-A Quad Scale, \$340.00. Dual Scale model, 12.5 KC and 25 KC ranges, only \$290.00.
- Oscilloscope jack for true wave form.
- 3-inch meter indicates directly in peak KC.



105-B 205-A

**FREE BOOKLET!**

**Send for "HOW TO MAKE MONEY IN MOBILE-RADIO MAINTENANCE".**

**MAIL COUPON TODAY!**

At no obligation to me, please send free booklet and information on Lampkin meters.

Name \_\_\_\_\_  
Address \_\_\_\_\_  
City \_\_\_\_\_ State \_\_\_\_\_ Zip \_\_\_\_\_

**LAMPKIN LABORATORIES, INC.**  
MFA Div., Bradenton, Fla. 33505

Circle 113 on reader's service card

**UHF/VHF SIGNAL SPLITTER, model CS-283.** Incorporates printed circuit. Vhf bandpass 0-235 MHz; uhf 400-1,000 MHz. 15 dB minimum isolation.

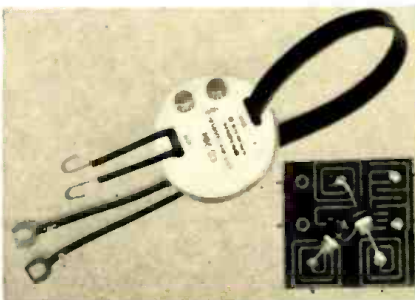

Pre-attached 300Ω wires connect to set's uhf and vhf antenna terminals or uhf converter.—Winegard Co.

Circle 74 on reader's service card



**LAVALIER MICROPHONE, model 545L Uni-dyne III,** unidirectional, dynamic. Response: 50-15,000 Hz. Impedance 150 ohms. Power level (1,000 Hz). -57.5 dB (1 mW with 10 μbar). 20-

foot 2-conductor shielded cable.—Shure Brothers, Inc.

Circle 75 on reader's service card

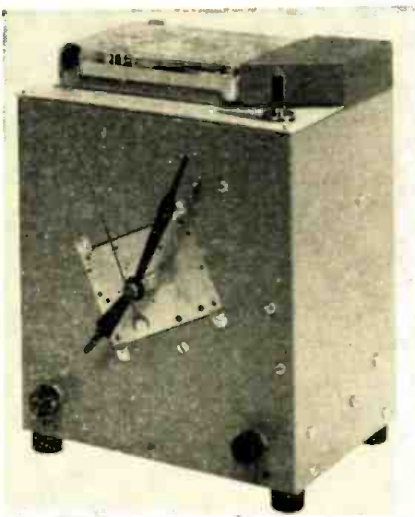

**TIME-CONTROLLED MAGNETIC TAPE PLAYER, the Audio-Chron,** plays tape recordings of chimes, bells, carillons, special announcements. Controlled by synchronous electric clock movement and prerecorded silent pulses on tape, contained in standard continuous-loop cartridge. 7-watt push-pull solid-state amplifier and speaker. 5½ x 7½ x 8 in., 11 lb.—Cosmic Voice, Inc.

Circle 76 on reader's service card

**STEREO HEADPHONES, Superex model ST-PRO,** feature dynamic woofer and ceramic tweeter elements for each ear. Response: 18-22,000 Hz. 7-ft 4-conductor cord terminating in standard stereo plug. Alternate plug terminations include two RCA phone tips, two mini-plugs or



two PL-55 phone plugs. Washable knit ear-cushion covers.—Electronics Div., Singer Products Co., Inc.

Circle 77 on reader's service card



**CARDIOID MICROPHONE, model 777.** Hand or stand use; rotary type on-off switch; rolled-off bass response. All-metal die-cast case, satin chrome-plated. Full fidelity. 150-ohm impedance, balanced line.—Turner Microphone Co.

Circle 78 on reader's service card

**NEW SPEAKER MODEL, the AR-4\*,** replaces the AR-4. 3½-in. tweeter has been replaced by 2½-in. unit with improved dispersion. Crossover frequency has been lowered from 2,000 to 1,200 Hz.

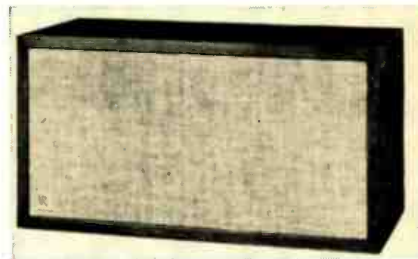

AR-4\* is compatible in stereo with the AR-4. Conversion kits available. No change in appearance.—Acoustic Research, Inc.

Circle 79 on reader's service card

# NEW LITERATURE

All booklets, catalogs, charts, data sheets and other literature listed here are free for the asking with a Reader's Service number. Turn to the Reader's Service Card facing page 78 and circle the number of items you want. Then detach and mail the card. No postage required!

**1966 ANNUAL CATALOG, No. 661.** 236 pages of radio, TV, electronics mail-order values. Illustrated, indexed by category and by manufacturer.—Burststein-Applebee Co.

Circle 80 on reader's service card

**INTEGRATED CIRCUITS PRODUCT GUIDE, CDL-820,** 12 pages, looseleaf-punched. Applications, specs, schematics and diagrams for linear integrated circuits and digital integrated circuits.—RCA Electronic Components & Devices

Circle 81 on reader's service card

**INDUSTRIAL/DEALER CATALOG C-3,** 4 pages, describes more than 90 products with prices: ribbon switches, mat switches, foot switches, safety-edge switches and chime/mat annunciator kits. Technical and circuit hints, applications data for controls, alarms, safety and automation.—Tape-switch Corp. of America

Circle 82 on reader's service card

**PROFESSIONAL TEST EQUIPMENT CATALOG, AP 22,** 12 pages, photos, prices. describes: two transistor analysts, transistorized portable color generator, complete TV analyst, capacitor analyst, tube testers, automatic scale multimeters and CRT testers.—B & K Mfg. Co.

Circle 83 on reader's service card

**TECHNICAL REPORT, Tunnel Diode Measurements,** 8 pages. Describes characteristics of typical microwave tunnel diodes, application requirements, stability conditions, technique of measuring negative resistance. 21 figures.—Sylvania Electric Products Inc.

Circle 84 on reader's service card

**BROCHURE, Performance Characteristics of Corning Microcircuit Resistors and Capacitors,** 8 pages, looseleaf-punched, contains 13 charts, a nomograph, a table and photographs.—Corning Electronic Products Div.

Circle 85 on reader's service card

**BULLETIN, TR-1016, "The Most Often Asked Questions on Soldering,"** 4 pages, written by the director of solder research and development.—Alpha Metals, Inc.

Circle 86 on reader's service card

**BOOKLET, The Turning Point in Television Tape Production,** handsomely illustrated in color, tells the story of the Ampex VR-2000 teleproduction videotape recorder.—Ampex Corp.

Circle 87 on reader's service card

**CATALOGS,** Electronics booklist, including many home-study courses; Audel list of handbooks on skilled trades; Skillfact Library how-to booklist; catalog covering Photofact Instrumentation Trainer.—Howard W. Sams & Co., Inc.

Circle 88 on reader's service card

**CRYSTALS CATALOG,** 60 pages, illustrated, technical data. Precision crystals for frequency control, oscillators, multivibrators, frequency meters, alignment oscillators, transmitters, sideband filters, antennas, etc.—International Crystal Mfg. Co., Inc.

Circle 89 on reader's service card

**20TH ANNIVERSARY CATALOG, 965 S 1,** 96 pages of video amplifiers, special effects, professional monitors, video test equipment, sync equipment, switching, programing, equalizers.—Denson Electronics Corp.

Circle 90 on reader's service card

**1966 CATALOG, Allied Electronics for Everyone.** 504 pages, illustrated; includes complete 93-page Knight-Kit catalog and components from acoustic insulation to Zener diodes.—Allied Electronics Corp.

Circle 91 on reader's service card

**TEST EQUIPMENT REFERENCE CHART,** 4 pages, contains typical test setups, dB to millivolt (microvolt) chart, return loss VSWR chart and transformation formulas.—Blonder-Tongue

Circle 92 on reader's service card

Write direct to the manufacturers for information on the items listed below:

**TRANSFER LETTERING AND DECAL CATALOG, No. DT-66,** 25¢ for catalog and samples. 8 pages, illustrates various type faces and symbols that can be ordered, and shows techniques. 27-sheet set of electronic words is available.—Russell Industries, Inc., 96 Station Plaza, Lynbrook, N.Y. 11563

**POWER SUPPLY HANDBOOK,** 5½ x 8½ in., 160 pages, starts with basic treatment of ac-dc rectification process, works up to regulating circuits both open and closed loop. Many circuit diagrams, block diagrams, photographs. Write on your company letterhead to: Publication Manager, Kepco, Inc., 131-38 Sanford Ave., Flushing, N.Y. END



**NEW!**

**BOOSTER-COUPLER**

from

**FINCO**

Available now . . . a new 2-tube, 4-set VHF-TV or FM Distribution Amplifier that's ideal for deluxe home or small commercial distribution systems. (Equipped with Finco low loss splitters #3001 or #3003, this BOOSTER-COUPLER can feed 16 or more sets!)

**FEATURES:** On-off switch, 117 volts, 60 cycles, 100% electronics tested, safe and rugged commercial construction, mount bracket and screws provided, AC receptacle and UL listed cord, no strip terminals. Minimum "snow". SIZE: 6½" x 3¾" x 3¾". MODEL: #65-1. LIST: \$29.95

Write for color brochure No. 20-338

The FINNEY Company • Dept. RE • 34 West Interstate Street/Bedford, Ohio

Circle 114 on reader's service card

**LATEST and GREATEST!**

**NEW**  
*Brach*  
**UHF/VHF**  
**TV ANTENNAS**  
FOR  
**Black/White & Color**

- Ultimate in Design!
- Unequaled in Performance!
- Outstanding in Value!

6651 Gold Finish  
6652 Chrome Finish

SEND FOR our latest catalog with our complete line of antennas

**BRACH MFG. CORP. DIV. of General Bronze Corp.**

899 Main Street, Sayreville, N.J. 08872

Circle 115 on reader's service card

JULY, 1966

87

www.americanradiohistory.com



# Where's the first place to look for electronic ideas? See the Gernsback book rack at your local parts distributor for facts, tips, hints, answers & know-how!

When you need professional help on tough electronics problems, go directly to the Gernsback Library Book Rack at your favorite electronics parts distributor. Here you'll find answers on radio and TV servicing, transistors, hobby projects, test instruments, audio, hi-fi, stereo, tape recording, communications, industrial electronics, to name just a few areas. Each book is designed to give you practical assistance in the field you desire. Examine the recent titles below.



### New Skill-Building Transistor Projects and Experiments

By Louis E. Garner, Jr. This unusual handbook helps you discover everything about transistors by actually doing things with transistors. Shows how to conduct experiments to gain new facts and prove key points. You'll assemble your own circuits, make your own tests, draw your own conclusions based on the knowledge you've acquired. Projects include: headphone amplifier, hi-fi preamplifier, power megaphone, cigar-box portable, electric eye, rain alarm, etc. 192 value-packed pages.

Order #129 ..... Softbound \$2.95



### Color TV Repair

By 10 Servicing Experts. Top technicians like David R. Anderson, Ed Bukstein, Jack Darr, Homer L. Davidson, Art Margolis, Robert Middleton and Warren Roy have created here an important tool for the profit-minded service technician. Tells you clearly and concisely just what can go wrong in color TV receivers and how to fix them. First each trouble symptom is described in detail, then a perfect solution is provided for the problem. Book covers color circuits, ABC's of color TV servicing, antennas and boosters, replacing the color picture tube, how to pinpoint the defective color section fast, servicing the chroma circuits, unexpected causes of TV color failure, troubleshooting with a color bar generator, color servicing tips, plus a glossary of color TV terms. 106 pages.

Order #123 ..... Softbound \$2.95

### Servicing AGC Circuits

By Harry E. Thomas. This practical how-to-do-it manual first shows you everything that can go wrong with AGC circuits and then goes on to reveal all you need to know to correct the trouble. Enables you to locate breakdowns quickly in AGC circuits, and then make your repairs rapidly and intelligently. Specific service approaches are plainly spelled out so you can use them immediately. Special emphasis is placed on TV troubleshooting, giving you the devices and techniques used in modern circuitry. Easy-to-read explanations, helpful illustrations. 204 pages, available through parts jobbers only.

Order #126 ..... Softbound \$3.95



### Probes for Test Instruments

By Bruno Zucconi and Martin Clifford. A probe is a link. It is a device you connect between a test instrument like a scope or v.t.v.m. and a radio or TV set being repaired. The finest scope or v.t.v.m. is limited by the kind of probe you use, and by how much you know about putting probes to work for you. Now comes this valuable handbook showing you in clear detail exactly what probe to use for a particular job. Covers crystal-demodulator probes, voltage-doubler probes, balanced probes, low-capacitance probes, high-voltage probes, isolation probes, direct probes, specialized probes, vacuum-tube and semiconductor probes. 224 pages, newly revised.

Order #54 ..... Softbound \$2.50



### The Handbook of Electronic Tables

By Martin Clifford. Here is an effective new approach to solving electronics problems. You don't have to make mathematical computations, or carry a slide rule or memorize any formulas whatsoever. Every answer you will ever need is worked out for you in 160 fact-packed pages of accurate electronic tables. Simply take the figures of your electronics problems and turn to the appropriate table. Then move your finger across the table and read the answer, instantly. You'll find these tables are easy to use, offer a wide choice of solutions and provide a high degree of accuracy.

Order #125 ..... Softbound \$2.95

**Get These Books At Your Parts Distributor or Mail This Coupon**

Gernsback Library, Inc., Dept. RE 67  
154 West 14th Street, New York, N.Y. 10011

Please send the books checked below. I enclose \$.....

(Prices 10% higher in Canada)

- 129 (\$2.95)       123 (\$2.95)  
 54 (\$2.50)       125 (\$2.95)

Name .....

Address .....

City ..... State..... Zip.....

My Distributor is .....

# WHAT'S YOUR EQ?

These are the answers. Puzzles are on page 43.

## Current-Valve Circuits

Both circuits serve as ripple filters. Circuit A is used in two RCA 12-inch transistor TV receivers to eliminate a large iron-core filter choke in the dc power supply.

In operation, reduced ripple applied to the base of Q1 by a network composed of R1, R2, C1 and R3. The output of Q1 is applied through R4 to the base of Q2. As a result, the base current of Q2 varies with changes in the collector current of Q1. This produces a variable voltage drop between the emitter and collector of Q2 which tends to counteract variations in the input voltage at the ripple rate. Consequently, the output voltage remains nearly constant at 30 volts.

In circuit B, a power pentode electronically regulates the output voltage as follows: A portion of the input ripple voltage is developed between the tap on the 50-ohm resistor and the tube's cathode. The reduced ripple voltage acts as a variable negative bias that is applied to the control grid through the 470K resistor. Another portion of the ripple voltage, which increases the effect of the variable negative bias, is applied to the control grid through the .05- $\mu$ F capacitor.

The variable negative bias automatically increases and decreases the voltage drop between the tube's cathode and plate. Within certain limits, this tends to counteract changes in the input voltage and, as a result, the output voltage remains nearly constant.

## Deflection-Coil Puzzler

(1) C; (2) B; (3) D.

## Switch-Pulse Circuit

Terminal A is at ground potential (zero) and terminal B varies from -9 to +9 volts. When switch is open, B is -9 volts. Closing the switch for one second changes the potential of B to +9 volts. This produces a 1-second pulse that is +9 volts above ground.

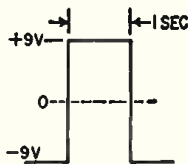

## Other Solutions

Because of inadequate description of the "Two Lamps" puzzler (Feb. R-E) several readers offered alternate solutions. These consisted mostly of a neon (or low-wattage incandescent lamp) in series with a larger incandescent lamp.

In operation, with the switch (connected across the smaller lamp) open, there is negligible voltage drop across the larger lamp. This causes smaller lamp to light with near normal voltage. With switch closed, the larger lamp receives full voltage.

One solution used 40-volt lamps with a transformer-operated resistor-bridge circuit. END

## Radio-Electronics Is Your Magazine!

Tell us what you want to see in it. Your suggestions may make it a better magazine for the rest of the readers as well as yourself. Write to the Editor, RADIO ELECTRONICS, 154 West 14th St., New York, N. Y. 10011.

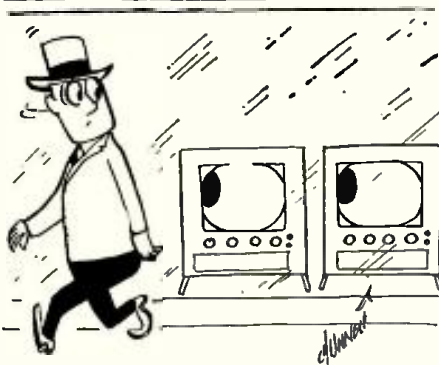

# Meet Winegard Chroma-Tel

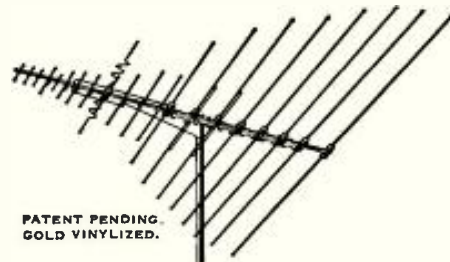

PATENT PENDING.  
GOLD VINYLIZED.

First 1/2 size all-band (UHF, VHF, FM) antenna with full size power

- Delivers Brilliant Color, Beautiful Black and White, Full-Tone FM Sound
- Brings in All the UHF, VHF and FM Stations in Your Area

Now there's an All-Band (UHF, VHF, FM) antenna that is actually half the size of most other all-band antennas. It eliminates half the bulk, half the wind loading, half the storage space, half the truck space and half the weight of ordinary all-band antennas... without sacrificing one bit of performance! Features Winegard's new Chroma-Lens Director System and impedance correlators.

Compare size, cost and performance... you'll choose Winegard Chroma-Tel every time. Ask your distributor or write for Fact-Finder #242 today.

3 Models from \$17.50 list.

**Winegard Co.** ANTENNA SYSTEMS

3000 Kirkwood • Burlington, Iowa

Circle 117 on reader's service card

# ELECTRONICS



## Engineering-Technicians

Bachelor of Science Degree, 30 Months  
Save Two Years' Time

- Radio-Television Plus Color Technician (12 Months)
- Electronics Engineering Technology (15 Months)
- Electronics Engineering (B.S. Degree)
  - Electrical Engineering (B.S. Degree)
  - Mechanical Engineering (B.S. Degree)
  - Civil Engineering (B.S. Degree)
  - Architecture (B.S. Degree)

The Nation's increased demand for Engineers, Electronic Technicians, Radio TV Technicians is at an all time high. Heald Graduates are in demand for Preferred High Paying Salaries. Train now for a lucrative satisfying lifetime career.

Approved for Veterans

DAY AND EVENING CLASSES

Write for Catalog and Registration Application. New Term Starting Soon.

# HEALD'S

ENGINEERING COLLEGE

Est. 1863-103 Years  
Van Ness at Post, RE  
San Francisco, Calif.

Your Name .....  
Address .....  
City .....  
State .....

Circle 118 on reader's service card

# SILICON RECTIFIER SALE

IMMEDIATE DELIVERY  
FULLY GTD NEWEST TYPE  
AMERICAN MADE FULLY TESTED

750 MA-SILICON "TOPHAT" DIODES  
LOW LEAKAGE FULL LEAD LENGTH

PIV/RMS 50/35 .05 ea.	PIV/RMS 100/70 .07 ea.	PIV/RMS 200/140 .10 ea.	PIV/RMS 300/210 .12 ea.
PIV/RMS 400/280 .14 ea.	PIV/RMS 500/350 .19 ea.	PIV/RMS 600/420 .21 ea.	PIV/RMS 700/490 .25 ea.
PIV/RMS 800/560 .30 ea.	PIV/RMS 900/630 .40 ea.	PIV/RMS 1000/700 .50 ea.	PIV/RMS 1100/770 .70 ea.

ALL TESTS AC & DC & FWD & LOAD

SILICON POWER DIODE STUDS				
D.C. AMPS	50 PIV 35 RMS	100 PIV 70 RMS	150 PIV 105 RMS	200 PIV 140 RMS
3	.08 ea.	.12 ea.	.16 ea.	.22 ea.
12	.25	.35	.45	.75
35	.65	.90	1.25	1.40
50	1.00	1.25	1.50	1.75
100	1.60	2.00	2.40	3.00

SILICON POWER DIODE STUDS				
D.C. AMPS	300 PIV 210 RMS	400 PIV 280 RMS	500 PIV 350 RMS	600 PIV 450 RMS
3	.27 ea.	.29 ea.	.37 ea.	.45 ea.
12	.90	1.30	1.40	1.65
35	2.00	2.35	2.60	3.00
50	2.20	2.55	3.00	3.50
100	3.60	4.50	5.25	7.00

"SCR" SILICON CONTROLLED RECTIFIERS "SCR"							
PRV	7 AMP	16 AMP	25 AMP	PRV	7 AMP	16 AMP	25 AMP
25	.50	.75	1.00	250	1.75	2.15	2.50
50	.60	.90	1.25	300	2.00	2.40	2.75
100	.80	1.25	1.50	400	2.40	2.75	3.25
150	.90	1.60	2.00	500	3.20	3.40	3.80
200	1.25	1.80	2.25	600	3.40	4.00	4.50

## SPECIALS! SPECIALS!

100 Different Precision Resistors  
1/2—1—2 Watt 1/2%—1% TOL \$1.25

Asst transistor Kit. P.N.P.—N.P.N.  
All popular types. Unchecked

100 for \$2.95 500 for \$9.95

TEXAS INSTRUMENT—POWER TRANSISTOR—85  
WATT—DIFFUSED NPN, SILICON MESA  
TYPE 2N424 FACTORY NEW \$1.50 EA

Computer Grade Condenser 15,500 MFD  
12 VDC American Mfg. .75 ea.

Type 1N34 DIODE GLASS .07 ea 100 for \$5

Money Back guarantee. \$2.00 min. order. Include  
additional \$ for postage. Send check or money  
order. C.O.D. orders 25% down.

Warren Electronic Components

230 Mercer St., N. Y., N. Y. 10012 • OR 3-2620

Circle 119 on reader's service card

# ITC

KNOWN THE WORLD OVER FOR  
ELECTRONIC VALUES

## NORTRONICS

# TAPE HEAD

LATEST TYPE

8 POLE — 1/4 TRACK  
STEREO "COMBO"  
RECORD — PLAY & ERASE

Medium-impedance  
for vacuum-tube or transistor circuits.

400 mhy 1 kc ind  
2500 ohm 1 kc imp  
100 kc max bias  
freq  
390 ohm dc res  
0.1 mil gap spacer  
.043 track width  
55 db 1 kc  
crosstalk rej



.136 track spacing  
center to center  
.42 ma 60 kc  
peak bias  
35 bias voltage  
35 ua rec current  
1.8 mw 1 kc output  
—3 db 10kc/1kc  
ratio  
REGULAR  
PRICE \$33.00

ITC

SPECIAL SALE PRICE

Calif. customers  
add 4%  
sales tax. **\$8.95** Add 40 Cents  
for postage  
and handling

Check or M.O. must accompany order. No C.O.D.

# INTERNATIONAL TELEVISION CORP.

2772 WEST OLYMPIC BLVD.  
LOS ANGELES, CALIF. 90006

Circle 120 on reader's service card

# NOTEWORTHY CIRCUITS

## ADD DIODE SQUELCH TO CB RIG

A squelch circuit makes monitoring communications channels a pleasure instead of an annoying chore. This applies to CB radio as well as to any other nonbroadcast service. The diagram shows a simple squelch that can be added to most transistor CB transceivers and monitor receivers. It was described by D. M. Hernandez in the magazine *U.R.E.* The circuit was de-

signed for transistor sets but can be used with tube equipment with minor modifications. Note that D2 is inserted in the audio signal path between the volume control and the first af amplifier. D2 is normally blocked by the negative volt-

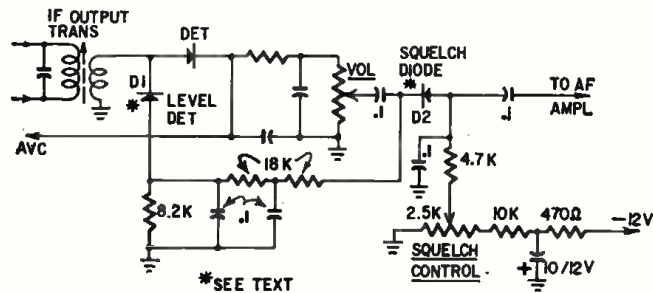

signed for transistor sets but can be used with tube equipment with minor modifications.

Note that D2 is inserted in the audio signal path between the volume control and the first af amplifier. D2 is normally blocked by the negative volt-

D1 and D2 were OA81's in the original circuit. You can substitute 1N462's or any similar diode. Values are shown for the components in the squelch circuit. Values of the unmarked components will vary, depending on the make and model of the set.

## AUDIO SWITCHING RELAY

A firm that uses a PA amplifier for background music asked me to install three mikes for remote paging and specified that the music should be muted when an announcement was being made over a mike. The amplifier and record player

fier through 330,000-ohm isolating resistors as shown. A shielded spdt plate relay was connected so its contacts ground out the preamp output in the normal position and the phono input when energized.

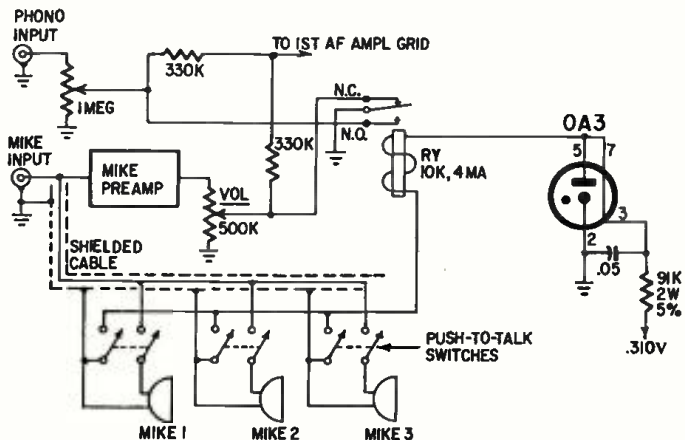

are close together. The nearest mike is to be 25 feet away and the farthest 250.

To keep costs down, I decided to use relay switching and push-to-talk mikes. The amplifier, a Newcomb E-17, is conventional, the phono input and mike preamp feeding the first af ampli-

Current for the relay is taken from the 310-volt supply. The OA3 tube limits the switching voltage to 75 to minimize wiring precautions necessary with higher voltages. The voltage drops to about 40 when the relay is energized.—John H. Hughes

END

# SCHOOL DIRECTORY

Get Your First Class Commercial

## F.C.C. LICENSE

and earn your

## A.S.E.E. DEGREE

Now is the time to Move Up! Increase your salary and prestige by acquiring the knowledge and documents that industry pays for. Get your F.C.C. first class commercial license, and then continue (if you wish) for your A.S.E.E. degree.

Grantham offers *resident* training in which each semester prepares you for an occupational objective as follows: Semester I—communications technician with first class F.C.C. license; semester II—television technician; semester III—computer technician; and semester IV—electronics *engineering* technician with an A.S.E.E. degree.

Grantham offers *home study* training in (1) F.C.C. License Preparation, and (2) Electronics Technology.

The A.S.E.E. degree can be earned by 16 months of resident training, or by a combination of the Electronics Technology course by home study and two semesters (8 months) in residence.

Get the facts from our free catalog. Write or phone us at one of the addresses listed below. Ask for *Catalog 67-E*.

### Grantham School of Electronics

1505 N. Western Ave., Hollywood, Cal. 90027  
(Phone: HO 9-7878)

408 Marion Street, Seattle, Wash. 98104  
(Phone: MA 2-7227)

818-18th St., NW, Washington, D.C. 20006  
(Phone: 298-7460)

Circle 121 on reader's service card

### LEARN Electronics AT HOME

Fix TV, design automation systems, learn transistors, complete electronics. College level Home Study courses taught so you can understand them. Earn more in the highly paid electronic industry. Computers, Missiles, theory and practical. Kits furnished. Over 30,000 graduates now employed. Resident classes at our Chicago campus if desired. Founded 1934. Catalog-

AMERICAN INSTITUTE OF ENGINEERING AND TECHNOLOGY  
1139 W. Fullerton Pky., Chicago, Ill. 60614

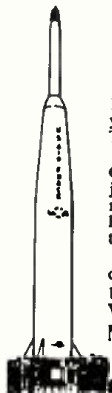

Learn Electronics for your SPACE-AGE EDUCATION at the center of America's aerospace industry

No matter what your aerospace goal, you can get your training at Northrop Tech, in sunny Southern California.

**COLLEGE OF ENGINEERING.** Get your B.S. degree in engineering in just 36 months by attending classes year round. Most Northrop Tech graduates have a job waiting for them the day they're graduated!

**A & P SCHOOL.** Practical experience on real aircraft. One-year course prepares you for F. A. A. A & P certificate. **WRITE TODAY FOR CATALOG.**

**NORTHROP INSTITUTE OF TECHNOLOGY**  
1199 W. Arbor Vitae, Inglewood, Calif.

### GET INTO ELECTRONICS

V.T.I. training leads to success as technicians, field engineers, specialists in communications, guided missiles, computers, radar and automation. Basic & advanced courses in theory & laboratory. Electronic Engineering Technology and Electronic Technology curricula both available. Assoc. degree in 29 mos. B.S. also obtainable. G.I. approved. Graduates in all branches of electronics with major companies. Start Sept., Feb. Dorms, campus. High school graduate or equivalent. Catalog.

**VALPARAISO TECHNICAL INSTITUTE**

Department C, Valparaiso, Indiana



### A JOB or a POSITION ?

The difference is ELECTRONIC MATHEMATICS

**NOW! A NEW WAY TO LEARN—I, H. S. I. WAY.** A complete home study course in electronic math to help you get the position you want—**MORE MONEY—MORE RESPECT.**

**COURSE PREPARED BY COLLEGE PROFESSORS** who have lectured to thousands of men on math and engineering. You learn at home quickly, easily—**AS FAST** as you want.

**YOU SIGN NO CONTRACTS** Pay only if satisfied—you owe it to yourself to examine the **INDIANA HOME STUDY INSTITUTE COURSE IN ELECTRONIC MATH.** **FREE BONUS**—if you join now, a refresher course in basic arithmetic.

Write for Brochure—No Obligation  
**THE INDIANA HOME STUDY INSTITUTE**  
Dept. RE-7, P.O. Box 1189  
Panama City, Fla. 32402

LEARN

# ELECTRONICS



FOUNDED 1899

NOT-FOR-PROFIT

## COYNE ELECTRONICS INSTITUTE

Electronics Engineering Technology	—	Degree (2 Yrs.)
Electrical-Electronics Technician	—	Diploma (40 Wks.)
TV-Radio-Electronics Technician	—	Diploma (40 Wks.)
Combined Electronics Technician	—	Diploma (80 Wks.)
Practical Electrical Maintenance	—	Diploma (32 Wks.)
Practical Refrigeration Air Conditioning and Appliance Repair	—	Diploma (24 Wks.)
Specialized Industrial Electronics	—	Diploma (16 Wks.)
Introduction to Electricity-Electronics	—	Certificate (8 Wks.)
FCC First Class Radiotelephone	—	Certificate (100 Hrs.)

Special finance plans. Part time employment service while in school. Also Free graduate employment service.



### ★ NEW GI BILL STARTS JUNE 1 ★

Use this coupon to get our **FREE BOOK "YOUR OPPORTUNITIES IN ELECTRONICS"**  
**COYNE ELECTRONICS INSTITUTE, Dept. of Electronics 86-N**  
1581 W. Congress Parkway, Chicago, Illinois 60607

Name \_\_\_\_\_ Age \_\_\_\_\_  
Address \_\_\_\_\_ Phone \_\_\_\_\_  
City \_\_\_\_\_ Zone \_\_\_\_\_ State \_\_\_\_\_

Unlike most other schools, we do not employ salesmen.

Circle 122 on reader's service card

### start your career here

Tri-State graduates hold important engineering and business administration posts throughout the U. S. Tri-State is a small professionally-oriented college in the beautiful lake section of NE Indiana. Excellent faculty . . . well-equipped labs . . . new library and residence halls . . . 300-acre campus . . . small classes . . . rich tradition. Fully accredited. Modest costs. Four-quarter Year permits degree in three years. One-year Drafting-Design Certificate program. For Catalog, write Director Admissions indicating career interest. Graduate placement outstanding!



### TRI-STATE COLLEGE

2476 College Avenue, Angola, Indiana

# NEW BOOKS

**INTEGRATED CIRCUITS, DESIGN PRINCIPLES AND FABRICATION.** Prepared by Engineering Staff, Motorola Semiconductor Products Div. Editors Raymond M. Warner, Jr., James N. Fardenwalt. McGraw-Hill Book Co., 330 W. 42 St., New York, N. Y. 10036. 7 1/4 x 10 1/4 in., 385 pp. Cloth, \$12.50

A complete engineering treatise on the subject, beginning with semiconductor and transistor theory and basic engineering, go-

ing on to integrated circuit designs and fabrication, actual processing, methods and problems of deposition, etc., and integrated circuit packaging. Possibly the most useful work on the subject yet printed.

**ELEMENTS OF PROBABILITY THEORY,** by L. Z. Rumshiskii. Pergamon Press, 44-01 21st St., Long Island City, N.Y. 11101. 5 1/2 x 8 1/2 in., 160 pp. Cloth, \$5.50

A reasonably brief coverage of this important branch of mathematics. Intended for graduate engineers, but useful to those with considerably less mathematics training.

**TRAVELING WAVES ON TRANSMISSION SYSTEMS,** by L. V. Bewley. Dover Publications, Inc., 180 Varick St., New York 14, N.Y. 5 1/2 x 8 1/2 in., 543 pp. Paper, \$3

Discusses waves and transients on lines and transformers, using operational calculus. The book is based on an advanced course for G-E engineers. **END**

JULY, 1966

91

# ADVERTISING INDEX

# MARKET CENTER

**RADIO-ELECTRONICS** does not assume responsibility for any errors which may appear in the index below.

Aerovox Corporation (Distributor Div.) .... 24  
 Allied Radio Corp. .... 82  
 Amperex Electronic Corp. .... Second Cover

B & K Manufacturing Co., (Div. of Dynascan Corp.) ..... Third Cover  
 Brach Manufacturing Corp. .... 87  
 Brooks Radio & TV Corp. .... 76, 77

Capitol Radio Engineering Institute, The .... 17  
 Castle TV Tuner Service, Inc. .... 65  
**CLASSIFIED** ..... 92-95  
 Cleveland Institute of Electronics ..... 20, 26-29  
 Columbia Stereo Tape Club ..... 7  
 Cornell Electronics Co. .... 94  
 Craig-Panorama, Inc. .... 70

Delta Products, Inc. .... 24  
 DeVry Technical Institute ..... 5

Eastman Kodak Company ..... 9  
 Electro-Voice, Inc. .... 10  
 Electronic Measurement Corp. (EMC) ..... 70

Finney Co. .... 65, 87

Gernsback Library, Inc. .... 67, 71, 88

Hallicrafters ..... 18  
 Heald's Engineering College ..... 89  
 Heath Company ..... 11, 25

International Crystal Mfg. Co., Inc. .... 96  
 International Radio Exchange ..... 22  
 International Television Corp. .... 90

Judson Research & Mfg. Co. .... 83

Lampkin Laboratories Inc. .... 86

Marantz, Inc. (Subsidiary of Superscope, Inc.) 21  
 Mercury Electronics Corporation ..... 72  
 Music Associated ..... 82

National Radio Institute ..... 12-15

Perma-Power Company ..... 23  
 Poly Paks ..... 95  
 Pyramid Assoc., Inc. .... 74

Quam-Nichols Co. .... 81  
 Quietrole Co. .... 77

RCA Components & Devices ..... Fourth Cover  
 RCA Institute, Inc. .... 8, 22, 63, 85  
 Radar Devices ..... 1

Sams & Co., Inc. Howard W. .... 64, 84  
 Scott, Inc., H.H. .... 8  
 Sencore ..... 75  
 Shure Bros. .... 19  
 Sprague Products Company ..... 16

Texas Crystals (Div. of Whitehall Electronics Corp.) ..... 83

United Radio Co. .... 93  
 University Sound (Div. of LTV Ling Altec, Inc.) ..... 85

Warren Electronic Components ..... 90  
 Winegard Co. .... 89

**MARKET CENTER** ..... 92-95  
 Chemtronics  
 Edmund Scientific Co.  
 Fair Radio Sales  
 Hart Publishing Co., Inc.  
 TAB  
 Television Utilities Corp.  
**SCHOOL DIRECTORY** ..... 91  
 American Institute of Engineering & Technology  
 Coyne Electronics Institute  
 Grantham School of Electronics  
 Indiana Home Study Institute  
 Northrop College of Science & Engineering  
 Tri-State College  
 Valparaiso Technical Institute

RADIO-ELECTRONICS



**TV SERVICE ORDER BOOKS** for use with your rubber stamp. Duplicate or triplicate. Low cost. Write for **FREE 32 PAGE CATALOG** and Special Rubber Stamp Offer. **OELRICH PUBLICATIONS**, 6556 W. Higgins, Chicago, Ill. 60656.

**CONVERT ANY TELEVISION** to sensitive Big-Screen Oscilloscope. Only minor changes required. No electronic experience necessary. Illustrated plans \$2.00. **RELCO-A25**, Box 10563, Houston 18, Texas.

**TUN O LUBE**

**BLACK/WHITE**  
OR  
**COLOR**

**THE ONLY SAFE NON-DRIFT TV TUNER CLEANERS**  
AVAILABLE AT ALL DISTRIBUTORS

**CHEMTRONICS**  
BROOKLYN, N. Y. 11236

**COLOR LUBE**

FREE CATALOG!

148 PAGES • NEARLY 4,500 BARGAINS  
OPTICS • SCIENCE • MATH

Completely new 1966 edition. New items, categories, illustrations. Dozens of electrical and electromagnetic parts, accessories. Enormous selection of Astronomical Telescopes, Microscopes, Binoculars, Magnifiers, Magnets, Lenses, Prisms. Many war surplus items for hobbyists, experimenters, workshop, factory. Write for catalog "EH".

CLIP AND MAIL COUPON TODAY

EDMUND SCIENTIFIC CO., Barrington, N.J. 08007  
PLEASE SEND ME FREE CATALOG "EH"

Name .....  
Address .....  
City ..... State ..... ZIP .....

New scientific transistor instrument detects buried coins, treasures. Will detect gold, silver, copper, iron, etc. \$19.95 up. Free catalog. **RELCO-A-25**, Box 10563, Houston 18, Texas.

**PRINTING PRESSES**, Type, Supplies. Lists 5¢. **TURNBAUGH SERVICE**, Mechanicsburg, Pa.

TRANSISTORS: Principles and Applications

By R. G. Hibberd,  
B.Sc., M.I.E.E., Sen.M.I.E.E.

In simple language, plus numerous explanatory diagrams, formulas and tables, this basic handbook describes various transistors and a profusion of circuits. Chapters on Radio Receivers, Switches, Amplifiers, Power Supplies, Solid Circuit Techniques, Recent Developments. \$5.95 postpaid, check or M.O. Satisfaction guaranteed.

Dept. RE, Hart Publishing Co., Inc.  
510 Sixth Ave., New York 10011

BIG CATALOG

World's "BEST BUYS" in GOV'T. SURPLUS Electronic Equipment

FULL OF TOP QUALITY ITEMS—

Transmitters, Receivers, Power Supplies, Inverters, Microphones, Filters, Meters, Cable, Keyers, Phones, Antennas, Chokes, Dynamotors, Blowers, Switches, Test Equipment, Headsets, Amplifiers, etc., etc. SEND 25¢ (stamps or coin) for CATALOG and receive 50¢ CREDIT on your order. Address Dept. RE.

FAIR RADIO SALES

P.O. Box 1105 • LIMA, OHIO • 45802

**CLASSIFIED COMMERCIAL RATE** (for firms or individuals offering commercial products or services): 60¢ per word . . . minimum 10 words.  
**NON-COMMERCIAL RATE** (for individuals who want to buy or sell personal items): 30¢ per word . . . no minimum.  
 Payment must accompany all ads except those placed by accredited advertising agencies. 10% discount on 12 consecutive insertions, if paid in advance. Misleading or objectionable ads not accepted. Copy for September issue must reach us before July 10th.  
**WORD COUNT:** Include name and address. Name of city (Des Moines) or state (New York) counts as one word each. Zone or Zip Code numbers not counted. (We reserve the right to omit Zip Code if space does not permit.) Count each abbreviation, initial, single figure or group of figures or letters as a word. Symbols or groups such as 8-10, COD, AC, etc., count as one word. Hyphenated words count as two words. Minor over-wordage will be edited to match advance payment.





# MARKET CENTER

TV Tuners Rebuilt and Aligned per Manufacturers specifications. All Makes—Color-B&W. Only \$9.50. We ship COD Ninety Day written guarantee. Ship complete with tubes or write for free mailing kit and dealer brochure. **VALLEY TUNERS**, 5641 A Cahuenga Blvd., North Hollywood, California.

**MESHNA CONVERTER KITS**, converts car radio for shortwave reception. Police, fire, marine, 30-50mc, 100-200mc, marine. Any kit \$5.00. Completely wired for use \$15.00. **MESHNA**, Lynn, Mass. 01904.

**RADIO & TV TUBES 33c each**. One year guaranteed. Plus many unusual electronic bargains. Free catalog. **CORNELL**, 4217-E University, San Diego, California 92105

**FREE ELECTRONICS CATALOG**. Tremendous bargains. Send postcard. **ELECTROLABS**, Department C-255-G, Hewlett, New York 11557

**VERSATILE VARIABLE A.C.-D.C. power pak plans**. 0.140V \$2.00 P.P. build for less than \$20.00. **H. McNICHOLS**, 220 Harmony, Elk Grove, Illinois 60007

**TV CAMERA KITS** including printed circuit and transistor models \$18.95 up! Send 25c for 1966 catalog. **ATV RESEARCH**, Box 396-R, So. Sioux City, Iowa.

**N I C A D Cells 2.3 AH (#2.3 SC) \$2.80 ea.** Meters 3" Round—150, 200 or 500 Ma DC—Choice \$3.50 each. **NEW YORK ELECTRONICS**, Dept. 11-C, 147 West 79th Street, New York, N.Y. 10024

**OCTOPULSE!** Reliable silicon semiconductor timing control boosts performance or economy 10% by eliminating all point arcing. Easiest installation, fail safe. 6 or 12 volt, positive, negative ground models. \$24.95. Two for \$44.50 Postpaid. Three year guarantee. **THE ELECTRON ENGINEERING & MANUFACTURING CO.**, Box 175, Hawthorne, California 90250

**Silicon Power Diodes Studs & P.F.\***

D. C. Amps	50Piv 35Rms	100Piv 70Rms	200Piv 140Rms	300Piv 210Rms
12	.30	.50	.70	.85
18*	.20	.30	.75	1.10
45	.80	1.25	1.80	2.25
150	2.50	2.50	3.50	4.50
240	3.75	4.75	7.75	10.45

D. C. Amps	400Piv 280Rms	500Piv 350Rms	600Piv 420Rms	750Piv 525Rms
12	1.10	1.30	1.55	1.75
18	1.50	2.00	2.70	3.40
45	3.25	3.50	3.90	4.50
150	5.40	6.50	7.50	12.00

1U4 Silicon Tube Rep. .... \$2 @ 6 for \$10  
5R4 Silicon Tube Rep. .... \$5 @ 2 for \$9

**"TAB" SILICON 1-AMP DIODES** Factory Guaranteed  
\*NEWEST TYPE! LOW LEAKAGE Gd.!

Piv/Rms	100/70	Piv/Rms	200/140	Piv/Rms	300/210
50/35	.10	100/70	.12	150/105	.15

Piv/Rms	400/280	Piv/Rms	500/350	Piv/Rms	600/420	Piv/Rms	700/490
50/35	.20	100/70	.25	150/105	.30	200/140	.35

Piv/Rms	800/560	Piv/Rms	900/630	Piv/Rms	1000/700
40	.40	900/630	.50	1000/700	.55

Send 25c for Catalog

\*ALL TESTS AC & DC & FWD & LOAD!

1700 Piv/1200Rms @ 750Ma \$1.20 @ 10Piv/PS10  
500Piv/770Rms 75c @ 16 for \$11

**"TAB" TERMS:** Money Back Guarantee. Our 21st year. \$2 Mln. order prepaid 48 states U.S.A.  
111 G-J Liberty St., N. Y. 6, N. Y.  
SEND 25c Phone: Rector 2-6245 for CATALOG

**BEGINNERS, BUILDERS** Giant catalog—25c, refundable. **LABORATORIES**, 993-B, Redwood City, California 94064.

**TV camera and control.** Fairbanks Morse. While they last \$495.00. One and only chance to get broadcast quality at such low prices.

**Camera BC 600A:** Band width over 8 megacycles, 650 lines minimum. Fully interlaced. Vidicon focused by mechanical control at rear of camera.

**Control Unit CC 600A:** Sync generator, scanning generator, video amp, and power supply. Plug in modules, waveform and adjusting points behind drop front panel.

Vidicons for above \$35.00. Lens prices on request.

**TELEVISION UTILITIES CORPORATION**  
10-11 50th Ave., Long Island City, N.Y. 11101  
Area Code 212 EXeter 2-8395

**NEON AC DC ELECTRIC TESTER**  
FOR HOME AUTO SHOP  
**Special! 59c**

**Special!**  
With every \$10 Order  
**25c per tube**  
(No Limit from this list)  
6AG5 6SN7  
6AQ5 6CB6 65A  
6AU6 6J6 6W4

**CORNELL TUBES**  
1 YR. GUARANTEED  
Mutual Conductance Lab-tested, Individually Boxed, Branded and Code Dated, Tubes are new, or used and so marked.

**21 PICTURE TUBES**  
139c 1 Yr. Guar. Authorized in COB's on Picture Tubes

**all purpose ELECTRONIC CLEANER**  
89c  
ELECTRONIC CLEANER  
CORNELL

**33c PER TUBE**

**100 TUBES OR MORE: 30c PER TUBE**

**Prestige & Success are yours as an ELECTRONIC EXPERT**  
FOR CORNELL CUSTOMERS ONLY by special arrangement with the publisher, these amazing bargains are available

**COMPLETE RADIO SERVICING AND BASIC ELECTRONICS COURSE ONLY \$3.00**  
(\$3.00 + \$0.50 shipping charge)

**NEW PRACTICAL TV TRAINING COURSE ONLY \$3.50**  
(\$3.50 + \$0.50 shipping charge)

**Both above courses \$6.00**

**Other tubes at low prices—send for free list**  
NO SUBSTITUTIONS WITHOUT YOUR PERMISSION

OZ4	6A55	6CD6	6K6	6X4	12BF6
1B3	6AT6	6CF6	6K7	6X8	12BH7
1J3/1K3	6AT8	6CG7	6O7	7A7	12BL6
1M5	6AU4	6CG8	65A	7AB	12BY7
1L4	6AU5	6CM7	6SA7	786	12C5
1T4	6AU6				12CA5
1U4	6AV6				12SN7
1X2	6AW8				12SQ7
3BZ6	6AX4				25L6
3DG4	6BA6				25Z6
5U4	6BC5				35W4
5U8	6BD6				35Z3
5Y4	6BG6				50L6
5Y3	6BJ6				24
6A6	6BL7				12AD6
6A8	6BN4				12AE6
6AB4	6BN6				27
6AC7	6BQ6				12AF6
6AG5	6BQ7				77
6AK5	6BZ6				12AT7
6AL5	6C4				78
6AN8	6C6				12A7
6AQ5	6C8				84/6Z4
	6D5				5687
	6E5				6350
	6F6				6463
	6G6				7044

**2X CHEATER CORDS**

**NOISE FILTER STOP RADIO INTERFERENCE INSTANTLY**

**DIODES/RECTIFIERS 39c per pack**  
sensational KIT VALUE

**SOLDERING GUN**  
SPECIAL LOW PRICE 2.99  
EASY TO HANDLE HOT SHOT  
ELECTRIC SOLDERING GUN

**Picture Xpander**  
99c

**ABC COLOR TV \$100**

**11,000 TUBE SUBSTITUTES**  
125c

**TERMS:** Add 3c per tube shipping. Orders under \$5.00 add 3c per tube shipping plus 50c handling. Canadian orders add approximate postage. Send 25c deposit on C.O.D. orders. No C.O.D. orders under \$5.00 or to Canada. No 24 hr. free offer on personal check orders. **3-DAY MONEY BACK OFFER!**

**CORNELL ELECTRONICS CO.**  
Dept. RE 7 4217 University Ave., San Diego, Calif. 92105

JAPAN & Hong Kong Electronics Directory, Products, components, supplies, 50 firms—just \$1.00. IPPANO KAISHA, LTD., Box 6266, Spokane, Washington 99207

WHOLESALE: Microphones 89¢, Transformers 34¢, Speakers 49¢, Hundreds of items, Catalog 25¢ Refundable. ROYAL, Box 2591, El Cajon, California 92021

ELECTRONIC PARTS, EQUIPMENT, and very unusual items at prices you won't find elsewhere. Catalog 50¢. S.D.E.C., 702 Market, San Diego, California

## GOVERNMENT SURPLUS

72 page illustrated Government Surplus Radio, Gadgets Catalog 25¢. MESHNA, Nahant, Mass.

## EDUCATION/ INSTRUCTION

LEARN ELECTRONIC ORGAN SERVICING. New home study course covering all makes electronic organ including transistors. Experimental kits—schematics—trouble-shooting. Accredited NHSC-GI Approved. Write for free booklet. NILES BRYANT SCHOOL, 3631 Stockton Blvd., Dept. F, Sacramento 20, Calif.

HIGHLY—effective home study review for FCC commercial phone exams. Free literature! COOK'S SCHOOL OF ELECTRONICS, Craigmont, Idaho 83523.

FCC LICENSE in 6 weeks. First Class Radio Telephone. Results Guaranteed. ELKINS RADIO SCHOOL, 2603E Inwood, Dallas, Tex.

SLEEP LEARNING. Hypnotism! Tapes, records, books, equipment. Details, strange catalog FREE. RESEARCH ASSOCIATION, Box 24-RD, Olympia, Wash.

BROADCASTING, Communications Electronics taught quickly—resident classes; correspondence. Free details. Write: Dept. 4, GRANTHAM SCHOOLS, 1505 N. Western, Hollywood, Calif. 90027

REI First Class Radio Telephone License in (5) weeks Guaranteed. Tuition \$295.00. Job placement free. RADIO ENGINEERING INSTITUTE, 1336 Main Street, Sarasota, Fla.

HOME ELECTRONICS COURSE only \$26.95. Free literature. Send postcard. EDU-KITS, Department 254 G, Hewlett, New York 11557

FCC License through tape recorded instruction. Bob Johnson, AUDIO-VISUAL TRAINING, 1060D Duncan, Manhattan Beach, Calif. 90266

ENGINEERING and Electronics—send \$1.00 for 100 page Career Opportunities. C.I.S.T., Suite 655, 263 Adelaide Street West, Toronto, Canada.

## EMPLOYMENT OPPORTUNITIES

"EMPLOYMENT RESUME GUIDE". Simplified Writing Instructions, Examples—\$2.00. MAGNETIC, Box 3677-REV, Washington 20007

**DOUBLE BONUS** PLUS CHOOSE ANY \$100 ITEM FREE

**\$25** WORTH OF  
 Transistors  
 Rectifiers  
 Condensers  
 Diodes  
 Knobs  
 Coils, etc.

Add 25¢ for handling

**BOTH FREE WITH ANY \$10 ORDER**

**LOW NOISE FETs FROM CRYSTALONIC** Vacuum Tube Equivalent

Field-effect transistors

**\$195** ELEC WORLD November for uses bookups.

spec sheet. N-channel

## FIRST TIME IN U.S.A! "ONE PRICE" SCRS!

Imagine 7-amp, 16-amp and 25-amp at one price! Just check the proper amp and PRV blocks.

<input type="checkbox"/> 7-Amps	<input type="checkbox"/> 16-Amps	<input type="checkbox"/> 25-Amps			
PRV	Sale	PRV	Sale		
<input type="checkbox"/> 25	.25	<input type="checkbox"/> 150	.80	<input type="checkbox"/> 300	1.75
<input type="checkbox"/> 50	.45	<input type="checkbox"/> 200	1.15	<input type="checkbox"/> 400	2.25
<input type="checkbox"/> 100	.70	<input type="checkbox"/> 250	1.35	<input type="checkbox"/> 500	2.50
		<input type="checkbox"/> 300	1.75	<input type="checkbox"/> 600	2.95

**SILICON POWER STUD RECTIFIERS**

AMPS	25 PIV	50 PIV	100 PIV	200 PIV
3	5¢	7¢	12¢	19¢
15	15¢	22¢	40¢	65¢
35	39¢	50¢	75¢	1.19
AMPS	400 PIV	600 PIV	800 PIV	1000 PIV
3	25¢	35¢	45¢	69¢
15	90¢	1.35	1.59	1.79
35	1.90	2.50	2.75	2.95

**750 MIL TOP HAT AND EPOXIES**

PIV	Sale	PIV	Sale	PIV	Sale
50	5¢	600	19¢	1400	95¢
100	7¢	800	29¢	1600	1.10
200	9¢	1000	51¢		
400	13¢	1200	69¢		

**WORLD'S MOST POPULAR \$1 PARTS PAKS**

- \$25 SURPRISE PAK: transistors, rect, diodes, etc. \$1
- 40 PRECISION RESISTORS, 1/2, 1, 2W, 1% values \$1
- 30 CORNING "LOW NOISE" resistors, ast. \$1
- 60 TUBULAR CONDENSERS, to .5mf, to 1KV, ast \$1
- 40 DISC CONDENSERS, 27mmf to .05mf to 1KV \$1
- 60 TUBE SOCKETS, receptacles, plugs, audio, etc. \$1
- 30 POWER RESISTORS, 5 to 50W, to 24 Kolms. \$1
- 50 MICA CONDENSERS, to .1mf, silver tool \$1
- 10 VOLUME CONTROLS, to 1 meg, switch tool \$1
- 10° ELECTROLYTICS, to 500mf, ast PP & tubular \$1
- 50 RADIO & TV KNOBS, ast. colors & styles \$1
- 10 TRANSISTOR ELECTROLYTICS: 10mf to 500mf \$1
- 50 COILS & CHOKES, if, rf, ant, osc, & more \$1
- 35 TWO WATTERS, ast incl: A.B., 5% tool \$1
- 75 HALF WATTERS, ast incl: A.B., 5% tool \$1
- 60 HI-Q RESISTORS, 1/2, 1, 2W, 1% & 5% values \$1
- 10 PHONO PLUG & JACK SETS, tuners, amps \$1
- MAGNETIC REED SWITCH, glass sealed \$1
- 30 "YELLOW" MYLAR CONDENSERS, ast val \$1
- 60 CERAMIC CONDENSERS, discs, npo's, to .05 \$1
- 40 "TINY" RESISTORS, 1/10W, 5% tool \$1
- 10 TRANSISTOR SOCKETS for pnp-npn transistors \$1
- 30 MOLDED COND'S, mylar, pore, black beauty \$1

**DELCO HIGH POWER \$1**

PNP 100Watt/15 Amp HPower  
 T036 Case1 2N441, 442, 277,  
 278, DS501 up to 50 Volts

2N1200 BVCHO 100 \$1.98

**ZENER VOLTAGE REGULATORS 1 WATT**

**3 For \$1**

Volts	Volts	Volts	Volts	Volts	Volts	Volts	Volts
<input type="checkbox"/> 6.8	<input type="checkbox"/> 10	<input type="checkbox"/> 15	<input type="checkbox"/> 22	<input type="checkbox"/> 33	<input type="checkbox"/> 47	<input type="checkbox"/> 68	<input type="checkbox"/> 100
<input type="checkbox"/> 7.5	<input type="checkbox"/> 11	<input type="checkbox"/> 16	<input type="checkbox"/> 24	<input type="checkbox"/> 36	<input type="checkbox"/> 51	<input type="checkbox"/> 75	<input type="checkbox"/> 110
<input type="checkbox"/> 8.2	<input type="checkbox"/> 12	<input type="checkbox"/> 18	<input type="checkbox"/> 27	<input type="checkbox"/> 39	<input type="checkbox"/> 56	<input type="checkbox"/> 82	<input type="checkbox"/> 120
<input type="checkbox"/> 9.1	<input type="checkbox"/> 13	<input type="checkbox"/> 20	<input type="checkbox"/> 30	<input type="checkbox"/> 43	<input type="checkbox"/> 62	<input type="checkbox"/> 91	<input type="checkbox"/> 130

10¢ FOR OUR "SUMMER" BARGAIN CATALOG ON:  
 Semiconductors  Poly Paks  Parts

**POLY PAKS**

TERMS: Send check, money order, Add postage—avg. wt. per Pak 1 lb. Rate d not 30 days. COD 25% deposit.

P.O. BOX 942R  
 SO. LYNNFIELD, MASS.  
 "PAK-KING" of the world

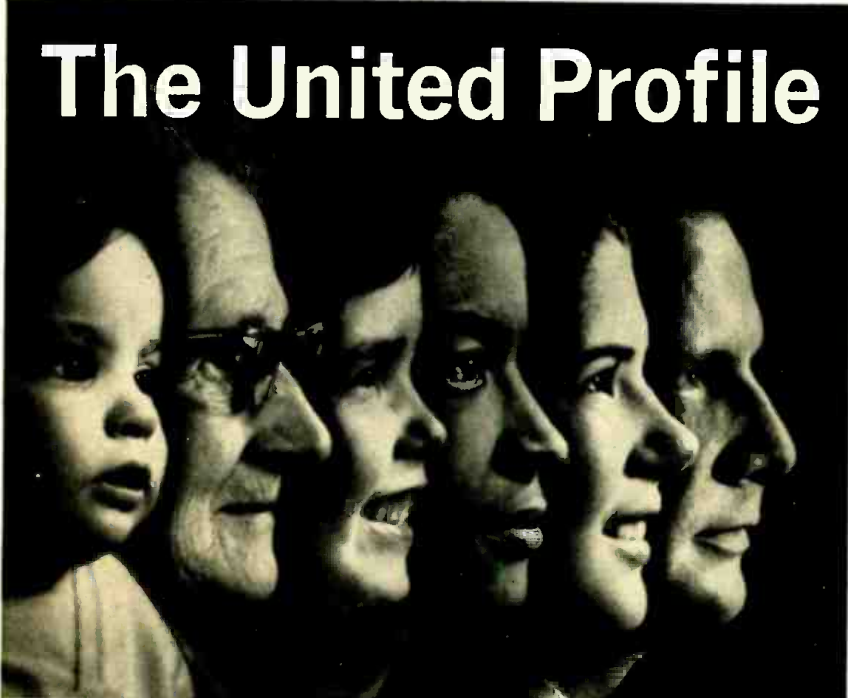

# The United Profile

When you give the United Way, you help all kinds of people in the community. Your one gift and that of 30 million other United contributors is working many wonders all year long to make our country a better place for all its citizens. More than 25 million families benefit from United Way services each year. From each of them to each of you who give, a heartfelt THANKS for a better life.

**Your One Gift Works Many Wonders/THE UNITED WAY**

# the International MO-23 citizens radio transceiver hides...



**under the dash ..... in the console ..... in the glove compartment**

The MO-23 remote control unit is so small it will rest on the palm of your hand (1½" H x 4" W x 2½" D). You can install the MO-23 under the car dash . . . in the glove or console compartment. Compare this versatile mobile two-way radio with other makes. See for yourself how little space this unit really requires. Technically speaking, the MO-23 combines the best advantages of tubes and silicon transistors.

### CHECK THESE FEATURES:

- 23 Crystal Controlled Channels
- Miniature Solid State Remote Control
- Illuminated Channel Selector
- Transmit/Receive Trunk Unit
- Transistor Power Supply

Ask your dealer to show you the International MO-23. We think it's a great new transceiver. You will too!

**WATCH FOR INTERNATIONAL "FLYING SHOWROOM '66".  
WELCOME ABOARD!**

*Circle 148 on reader's service card*

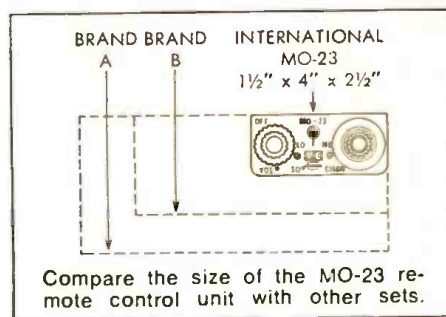

FCC Citizens Radio license required. All use must conform with Part 95, FCC Rules and Regulations.



**CRYSTAL MFG. CO., INC.**  
18 NO. LEE · OKLA. CITY, OKLA. 73102

RADIO-ELECTRONICS



B&K MODEL 970 RADIO ANALYST

**NEW!**

# SERVICE AM & FM AUTO AND TRANSISTOR RADIOS AT A PROFIT!

Jobs that used to be unprofitable now go so quickly that you can make good money handling them! There are millions of auto radios and transistor radios in the field—portables, auto and table models, plus hi-fi and communications equipment. Instead of turning them away, you can turn them into money-makers with the B&K Model 970 Radio Analyst.

The 970 is effective because it's *accurate and complete*. Using the famous B&K signal injection technique, this all-in-one instrument provides the required dc power, lets you test power and signal transistors in and out of circuit; generates RF and audio signals, and includes a rugged, accurate VOM. Four functions in one compact package—with solid state reliability, B&K professional quality.

## LOW INVESTMENT—QUICK RETURN

See your B&K Distributor or write for Catalog AP22-R

Net \$199<sup>95</sup>



**B & K MANUFACTURING CO.**  
DIVISION OF DYNASCAN CORPORATION  
1801 W. BELLE PLAINE AVE. • CHICAGO, ILL. 60613

Export: Empire Exporters, 123 Grand St., New York 13, U.S.A.  
Circle 149 on reader's service card

## FEATURES:

### BUILT-IN POWER SUPPLY

**Auto Radios**—High current, low-ripple, for transistor, hybrid, and vibrator types.

**Transistor Portables**—1½ to 12 volts for battery substitution—plus separately variable voltage tap for bias.

### QUICK AND ACCURATE TESTING OF POWER AND SIGNAL TRANSISTORS

**In-Circuit**—stage by stage DC signal injection and sensitive metering of power supply current.

**Out-of-Circuit**—Direct Beta and Leakage meter scale readings. Easy balancing or matching.

### VERSATILE SIGNAL GENERATORS

**RF Generators**—provide broadcast and IF frequencies for both AM and FM bands.

**Audio Generator**—for AM or FM modulation of the RF signals, and for troubleshooting audio circuits.

### RUGGED VOM

**Volt-OHM-Milliammeter**—with rugged, taut band meter—provides correct ranges for easy, fast servicing of all home and auto radios, as well as transistor portables.



## Blooming?

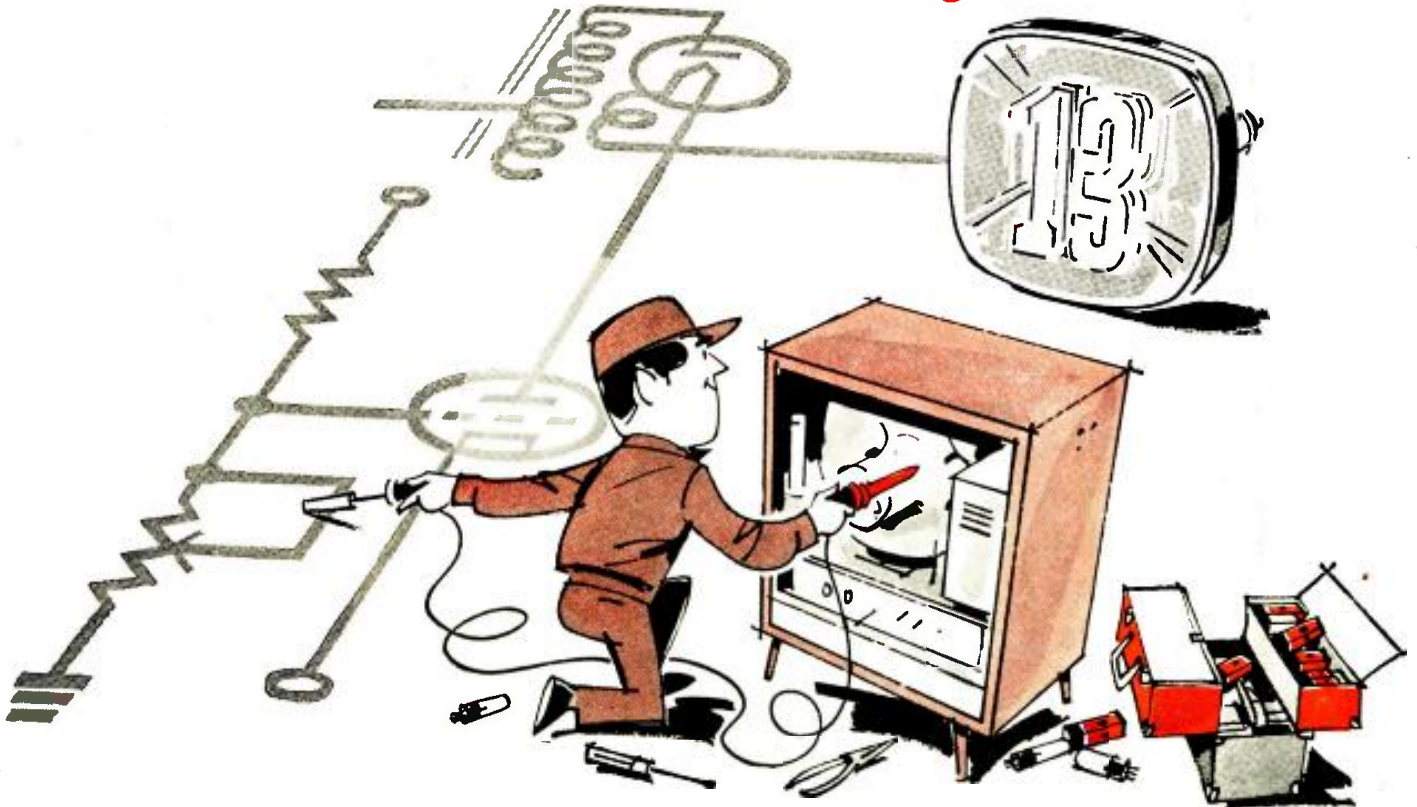

## ...Varying picture size? Misconvergence?

### Check the high voltage regulator section

Poor high-voltage regulation in color sets can be the cause of many needless call-backs, and in some cases, the outright loss of a valued customer. Merely replacing tubes in the horizontal and high voltage sections could result in a premature tube failure brought about by improper high voltage regulator action. Follow these simple FAST-CHECKS and make your color set servicing life a little easier.

1. Determine the proper value for the high voltage by checking the service notes of the receiver. Measure the high voltage at the picture tube anode connection and adjust the high voltage control for the specified value.
2. Turn the brightness control back and forth. If during this adjustment you get blooming, varying picture size and misconvergence, measure the cathode current of the high voltage regulator tube with the brightness turned down. If the regulator tube cathode current is below the specified minimum when the correct high-voltage is attained, the high-voltage input to the regulator system is probably low.
3. To correct small errors in the high-voltage input to the regulator tube, measure cathode current in the horizontal deflection output tube and adjust the horizontal efficiency coil for the specified current.
4. If this adjustment does not increase the regulator tube cathode current to the specified value, check the horizontal output tube, the damper tube and the drive to the horizontal output tube.
5. After making any adjustments or changes required in step 4, rotate the brightness control. If the shunt regulator tube is in good operating condition and you have made the proper adjustments, the blooming, varying picture size, and misconvergence will disappear.

Before replacing a shunt regulator tube, always follow the procedure above. You'll save time and money and have a satisfied customer.

This color TV service hint is another in a series of service hints from RCA. When you order receiving tubes, always specify "RCA". You'll find your customers better satisfied and you'll have fewer callbacks.

RCA ELECTRONIC COMPONENTS AND DEVICES, HARRISON, N. J.



The Most Trusted Name in Electronics